

**LS-OPT<sup>®</sup> User's Manual**

**A DESIGN OPTIMIZATION AND  
PROBABILISTIC ANALYSIS TOOL  
FOR THE ENGINEERING ANALYST**

**NIELEN STANDER, Ph.D.  
WILLEM ROUX, Ph.D.  
TUSHAR GOEL, Ph.D.  
TRENT EGGLESTON, Ph.D.  
KEN CRAIG, Ph.D.**

**August 2012  
Version 4.3**

Copyright © 2012  
**LIVERMORE SOFTWARE  
TECHNOLOGY CORPORATION**  
All Rights Reserved

**Corporate Address**

Livermore Software Technology Corporation  
P. O. Box 712  
Livermore, California 94551-0712

**Support Addresses**

Livermore Software Technology Corporation  
7374 Las Positas Road  
Livermore, California 94551  
Tel: 925-449-2500 ♦ Fax: 925-449-2507

**Email:** [sales@lstc.com](mailto:sales@lstc.com)

**Website:** [www.lstc.com](http://www.lstc.com)

**LS-OPT support site:** [www.lsoptsupport.com](http://www.lsoptsupport.com)

**LS-OPT Users Group:**

[http://groups.google.com/group/lsopt\\_user\\_group](http://groups.google.com/group/lsopt_user_group)

Livermore Software Technology Corporation  
1740 West Big Beaver Road  
Suite 100  
Troy, Michigan 48084  
Tel: 248-649-4728 ♦ Fax: 248-649-6328

**Disclaimer**

Copyright © 1999-2012 Livermore Software Technology Corporation. All Rights Reserved.

LS-DYNA®, LS-OPT® and LS-PrePost® are registered trademarks of Livermore Software Technology Corporation in the United States. All other trademarks, product names and brand names belong to their respective owners.

LSTC reserves the right to modify the material contained within this manual without prior notice.

The information and examples included herein are for illustrative purposes only and are not intended to be exhaustive or all-inclusive. LSTC assumes no liability or responsibility whatsoever for any direct or indirect damages or inaccuracies of any type or nature that could be deemed to have resulted from the use of this manual.

Any reproduction, in whole or in part, of this manual is prohibited without the prior written approval of LSTC. All requests to reproduce the contents hereof should be sent to [sales@lstc.com](mailto:sales@lstc.com).

8/22/2012

# PREFACE TO VERSION 1

LS-OPT originated in 1995 from research done within the Department of Mechanical Engineering, University of Pretoria, South Africa. The original development was done in collaboration with colleagues in the Department of Aerospace Engineering, Mechanics and Engineering Science at the University of Florida in Gainesville.

Much of the later development at LSTC was influenced by industrial partners, particularly in the automotive industry. Thanks are due to these partners for their cooperation and also for providing access to high-end computing hardware.

At LSTC, the author wishes to give special thanks to colleague and co-developer Dr. Trent Eggleston. Thanks are due to Mr. Mike Burger for setting up the examples.

Nielen Stander  
Livermore, CA  
August, 1999

# PREFACE TO VERSION 2

Version 2 of LS-OPT evolved from Version 1 and differs in many significant regards. These can be summarized as follows:

1. The addition of a mathematical library of expressions for composite functions.
2. The addition of variable screening through the analysis of variance.
3. The expansion of the multidisciplinary design optimization capability of LS-OPT.
4. The expansion of the set of point selection schemes available to the user.
5. The interface to the LS-DYNA binary database.
6. Additional features to facilitate the distribution of simulation runs on a network.
7. The addition of Neural Nets and Kriging as metamodeling techniques.
8. Probabilistic modeling and Monte Carlo simulation. A sequential search method.

As in the past, these developments have been influenced by industrial partners, particularly in the automotive industry. Several developments were also contributed by Nely Fedorova and Serge Terekhoff of SFTI. Invaluable research contributions have been made by Professor Larsgunnar Nilsson and his group in the Mechanical Engineering Department at Linköping University, Sweden and by Professor Ken Craig's group in the Department of Mechanical Engineering at the University of Pretoria, South Africa. The authors also wish to give special thanks to Mike Burger at LSTC for setting up further examples for Version 2.

Nielen Stander, Ken Craig, Trent Eggleston and Willem Roux  
Livermore, CA  
January, 2003



# PREFACE TO VERSION 3

The development of LS-OPT has continued with an emphasis on the integration with LS-DYNA and LS-PREPOST and differs from the previous version in the following significant regards:

1. LS-OPT is now available for Microsoft Windows.
2. Commands have been added to simplify parameter identification using continuous curves of measured data.
3. Stochastic fields have been added to LS-DYNA (Version 971) to provide the capability of modeling geometric and shell thickness variability.
4. Extended visualization of statistical quantities based on multiple runs were implemented by further integrating LS-PREPOST.
5. An internal `d3plot` interface was developed.
6. Reliability-Based Design Optimization (RBDO) is now possible using the probability of failure in the design constraints.
7. Neural network committees were introduced as a means to quantify and generalize response variability.
8. Mixed discrete-continuous optimization is now possible.
9. Parameter identification is enhanced by providing the necessary graphical pre- and postprocessing features. Confidence intervals are introduced to quantify the uncertainty of the optimal parameters.
10. The importation of user-defined sampling schemes has been refined.
11. Matrix operations have been introduced.
12. Data extraction can be done by specifying a coordinate (as an alternative to a node, element or part) to identify the spatial location. The coordinate can be referred to a selected state.
13. A simple feature is provided to gather and compress the database for portability.
14. A utility is provided to both reduce the `d3plot` file sizes by deleting results and to transform the `d3plot` results to a moving coordinate system.
15. Checking of LS-DYNA keyword files is introduced as a means to avoid common output request problems.
16. Statistical distributions can be plotted in the distribution panel in the GUI.
17. A feature is introduced to retry aborted runs on queuing systems.
18. 3-Dimensional point plotting of results is introduced as an enhancement of metamodel plotting.
19. Radial basis function networks as surrogate models.
20. Multi-objective optimization for converging to the Pareto optimal front (direct & metamodel-based).
21. Robust parameter (Taguchi) design is supported. The variation of a response can be used as an objective or a constraint in the optimization process.
22. Mapping of results to the FE mesh of the base design: the results are considered at fixed coordinates. These capabilities allow the viewing of metalforming robustness measures in LS-PREPOST.
23. The ANSA morpher is supported as a preprocessor.
24. The truncated normal distribution is supported.
25. Extra input files can be provided for variable parsing.
26. A library-based user-defined metamodel is supported.
27. User-defined analysis results can be imported.
28. PRESS predictions can be plotted as a function of the computed values.
29. The DynaStats panel has been redesigned completely (Version 3.4)

30. Strategies for metamodel-based optimization are provided as GUI options
31. An algorithm panel has been added for setting optimization algorithm parameters.
32. User-defined sampling points can be evaluated using an existing metamodel.
33. The Adaptive Simulated Annealing algorithm has been added as a core optimization solver. Hybrid algorithms such as the Hybrid SA and Hybrid GA have also been added.
34. Kriging has been updated and accelerated.
35. Enhancements were made to the Accuracy selection in the viewer by allowing color-coded point attributes such as feasibility and iteration number.
36. The Tradeoff selection has also been enhanced by converting it to a 3-D application with color coding for the 4<sup>th</sup> dimension as well as color status of points for feasibility and iteration number.

As in the past, these developments were strongly influenced by industrial partners, particularly in the automotive industry. LS-OPT is also being applied, among others, in metal forming and the identification of system and material parameters. In addition to long-time participants: Professor Larsgunnar Nilsson (Mechanical Engineering Department, Linköping University, Sweden) and Professor Ken Craig (Department of Mechanical Engineering, University of Pretoria, South Africa), significant contributions have been made by Dr. Daniel Hilding, Mr. David Björkevik and Mr. Christoffer Belestam of Engineering Research AB (Linköping) as well as Dr.-Ing. Heiner Müllerschön, Dipl.-Ing. Marko Thiele and Dipl.-Math. Katharina Witowski of DYNAmore GmbH, Stuttgart, Germany.

Nielen Stander, Willem Roux and Tushar Goel

Livermore, CA

January, 2009

# PREFACE TO VERSION 4

The development of LS-OPT has continued with an emphasis on the integration with LS-DYNA and LS-PREPOST. The main focus of Version 4 has been the development of a new graphical postprocessor as well as the improvement of the job scheduling system, especially with regard to scheduling on computer clusters. The following features have been added:

## Version 4.0:

1. The Viewer has been redesigned completely to accommodate a multi-window format using a split-window and detachable window feature.
2. The Correlation matrix for simulation variables and results has been added.
3. For visualizing the Pareto Optimal Frontier, Hyper-Radial Visualization and Parallel Coordinate plots have been added to the more traditional scatter plot. Multiple points can be selected to create a table of response values. Point highlighting is cross-connected between plot types.
4. An interface for the METAPost postprocessor has been added.
5. Topology optimization LS-OPT<sup>®</sup>/Topology has been added as a separate module. Please refer to the LS-OPT/Topology User's Manual.
6. Many of the features such as the Reliability-Based Design Optimization have been significantly accelerated.
7. The Blackbox queuing system has been streamlined in terms of providing better diagnostics and a special queuing system *Honda* has been added.
8. The NASTRAN<sup>®</sup> interface for frequency extraction and mode tracking has been added.

## Version 4.1:

9. Discrete sampling can be done on a variable by variable basis for most sampling schemes including *D-Optimality*, *Space Filling* and *Full Factorial*.
10. The *Space Filling* algorithm has been improved for accuracy and speed.
11. Job scheduling has been significantly improved. Environment variables can be exported through queuing systems.
12. Job data is displayed on the run progress bars with a selection to view the solver log file at any stage of the run.
13. Three injury criteria: *a3ms*, *Chest Compression* and *Viscous Criterion* have been added.
14. *SPH*, *DBBEMAC* and *NODFOR* groups have been added to the LS-DYNA response interface.
15. *GenEx*, the LS-OPT Generic Extractor provides features for extracting entities from text files. This allows LS-OPT to be used with any solver code that produces a text database.
16. Responses can be linked to LS-DYNA cases (\*CASE keyword).

17. In addition to polynomials, Radial Basis Functions can now be used for parameter identification.
18. The following features have been added to the Viewer: Self-Organizing Maps (for multi-objective optimization), two-dimensional interpolation matrix using metamodels, global sensitivities (Sobol), Computed (simulation) and Predicted (metamodel) histories, Parallel Coordinate plot for simulation results.
19. Experiments can be replicated for stochastic fields. Improvements have been made to Stochastic Fields (\*PERTURBATION) in LS-DYNA. Special coordinate systems have been added. \*PERTURBATION\_MATERIAL has been added for MAT24.
20. To avoid synchronization errors, the Experiments and AnalysisResults databases have been converted to self-contained .csv files.
21. The Run page has been rationalized. Clean start options are now available for all tasks.
22. A selected subset of Pareto optimal points can be exported to a standard format. The file can be used to schedule the points as simulations.

#### Version 4.2:

23. The algorithm for constrained experimental design has been greatly improved. An optimization algorithm was introduced to locate design points within specified constraint bounds.
24. LSTCVM has been added as a Secure Proxy Server for distributing solver jobs across a computer cluster. Running LS-OPT on a Windows machine controlling solver jobs on a Linux cluster is now possible.
25. Individual jobs can be stopped using LSKILLJOB from the LS-OPT GUI. This feature has been implemented to kill lagging jobs which tend to hold up the entire optimization run. Accelerated job killing is provided as an option. A job can also be flagged for restart. LSTCVM and LSKILLJOB combined with LSCHEMULER and other auxiliary programs provide a sophisticated job distribution system.
26. More injury criteria are now available, namely MOC, NNIC, NIC, Nkm, LNLI, TTI and TI. A 3-node version of the injury criterion *Clip3m* has been added.
27. Kinematics for NODOUT-based responses and histories. Includes the calculation of deformation and distance in global, local and local-in-reference-frame coordinate systems.
28. DBFSI (fluid structure interaction) is available in the history and response interfaces.
29. Curve Mapping has been added to improve the curve matching metric for material identification, especially for hysteretic curves, curves with steep sections and cases where only partial test data is available. A newly developed Partial Curve Mapping algorithm is used.
30. Metamodel prediction accuracy based on PRESS error has been added as a stopping criterion for the Sequential Response Surface Method (SRSM).
31. Automatic internal constraint scaling based on the constraint bounds has been added to the GUI. This feature ensures that constraint violations are treated equally irrespective of their magnitudes.
32. The *Dominated Hypervolume* method as a stopping criterion for multi-objective optimization methods (GA). *Crowding Distance* and *Spread* of the Pareto Optimal Front can be monitored graphically.

33. Self-Organizing Maps is available to visualize simulation results.
34. Refinements have been made to the 2D Metamodel Cross-Section display by adding simulation points. The History display was improved by allowing the selection and display of multiple histories. There is stronger unification amongst the different types of displays.
35. LS-OPT database archiving has been expanded to include extra files such as solver input files.
36. Histories have been added to the GenEx (generic extraction) result extraction feature. In the past, only responses could be extracted.
37. The input file environment can be used to store include files. LS-OPT will in this case automatically be able to parse and transmit the files (e.g. to a cluster).
38. A derivative history function has been added to compute the derivative of a time history, e.g. acceleration from velocity.
39. A general filtering feature for time histories has been added. Filtering has been available for LS-DYNA-extracted data, but can now be applied to any time history, also those produced using expressions or generic extraction.

#### Version 4.3

40. The MAC criterion replaces the Generalized Mass criterion for mode tracking (merged to Version 4.2). An option to turn off mode tracking was added.
41. Mode tracking is supported for all versions of LS-DYNA, including LS-DYNA MPP (merged to Version 4.2).
42. Sampling of the Pareto Optimal Front as a sampling option. A Space Filling algorithm, to maximize the distance between any two points in the design space, is used.
43. Option for selecting the number of verification runs for the trade-off curve of multi-objective optimization. Space Filling sampling is done to obtain a well-distributed trade-off set.
44. Head injury criterion (HIC) using three nodes for the different coordinate directions.
45. Support Vector Regression introduced as a metamodeling type.
46. User-defined postprocessor option.

The automotive and other industries have again made significant contributions to the development of new features in LS-OPT. In addition to long-time participant Professor Larsgunnar Nilsson (Mechanical Engineering Department, Linköping University, Sweden), Dr. Daniel Hilding, Mr. David Björkevik and Mr. Christoffer Belestam of Engineering Research AB (Linköping) as well as Dr.-Ing. Heiner Müllerschön and Dipl.-Math. Katharina Witowski of DYNAmore GmbH, Stuttgart, Germany have made major contributions as developers. Dr. Trent Eggleston has recently created LSTCVM and LSKILLJOB and, while working with customers, has made vast improvements to solver job scheduling via queuing systems.

Nielen Stander and Anirban Basudhar

Livermore, CA

August, 2012



# TABLE OF CONTENTS

Preface to Version 1 .....	iii
Preface to Version 2 .....	iii
Preface to Version 3 .....	v
Preface to Version 4 .....	7
Table of Contents .....	11
Table of Figures .....	24
1. Introduction .....	31
1.1. Overview of the manual .....	33
2. Response Surface Methodology .....	35
2.1. Introduction .....	35
2.1.1. Approximating the response .....	35
2.1.2. Factors governing the accuracy of the response surface .....	37
2.1.3. Advantages of the method .....	37
Design exploration .....	37
Global optimization .....	37
2.1.4. Other types of response surfaces .....	37
2.2. Experimental design .....	37
2.2.1. Factorial design .....	38
2.2.2. Koshal design .....	38
First order model .....	38
Second order model .....	38
2.2.3. Central composite design .....	39
2.2.4. D-optimal design .....	39
2.2.5. Latin Hypercube Sampling (LHS) .....	40
Maxi-min .....	41
Centered L2-discrepancy .....	41
2.2.6. Space-filling designs .....	41
2.2.7. Random number generator .....	45
2.2.8. Reasonable experimental designs .....	45
2.3. Model adequacy checking .....	45
2.3.1. Residual sum of squares .....	45
2.3.2. RMS error .....	46
2.3.3. Maximum residual .....	46
2.3.4. Prediction error .....	46
2.3.5. PRESS residuals .....	46
2.3.6. The coefficient of multiple determination $R^2$ .....	47
2.3.7. $R^2$ for Prediction .....	47
2.3.8. Iterative design and prediction accuracy .....	48
2.4. ANOVA .....	48
2.4.1. The confidence interval of the regression coefficients .....	48
2.4.2. The significance of a regression coefficient $b_j$ .....	49
2.5. REFERENCES .....	49

3.	Metamodeling Techniques.....	51
3.1.	Neural networks.....	51
3.1.1.	Model adequacy checking.....	55
3.1.2.	Feedforward neural networks.....	57
3.1.3.	Radial basis function networks.....	61
3.2.	Kriging*.....	65
3.3.	Concluding remarks: which metamodel?.....	66
3.4.	REFERENCES.....	67
4.	Optimization.....	70
4.1.	Theory of optimization.....	70
4.2.	Normalization of constraints and variables.....	71
4.3.	Gradient computation and the solution of optimization problems.....	72
4.4.	Optimization methods.....	73
4.5.	Strategies for metamodel-based optimization.....	74
4.5.1.	Single stage.....	74
4.5.2.	Sequential strategy.....	74
4.5.3.	Sequential strategy with domain reduction.....	74
4.5.4.	How do I choose an appropriate strategy for metamodel-based optimization?.....	75
4.6.	Sequential response surface method (SRSM).....	75
4.7.	Leapfrog optimizer for constrained minimization (LFOPC).....	78
4.8.	Genetic algorithm.....	79
4.8.1.	Terminology.....	79
4.8.2.	Encoding.....	80
4.8.3.	Algorithm.....	80
Initialization.....	81	
Function evaluation.....	81	
Selection or reproduction operator.....	81	
Crossover.....	82	
Mutation.....	83	
Elitism in simple genetic algorithm.....	83	
Stopping criterion.....	83	
4.9.	Multi-objective optimization using genetic algorithms.....	84
4.9.1.	Non-domination criterion.....	84
4.9.2.	Pareto optimal solutions.....	84
4.9.3.	Pareto optimal set.....	85
4.9.4.	Pareto optimal front.....	85
4.9.5.	Ranking.....	85
4.9.6.	Convergence vs. diversity.....	86
4.9.7.	Elitist non-dominated sorting genetic algorithm (NSGA-II).....	86
4.9.8.	Elitism in NSGA-II.....	88
4.9.9.	Diversity preservation mechanism in NSGA-II – crowding distance calculation.....	89
4.10.	Adaptive simulated annealing (ASA).....	89
4.10.1.	Algorithm.....	89
4.10.2.	Acceptance function.....	90
4.10.3.	Sampling algorithm.....	91
4.10.4.	Cooling schedule.....	92



4.10.5. Stopping criterion.....	92
4.10.6. Re-annealing .....	93
4.11. Hybrid algorithms .....	94
4.12. Visualization of the Pareto optimal frontier.....	95
4.12.1. Trade-off plot.....	95
4.12.2. Hyper-radial visualization (HRV).....	95
4.12.3. Parallel co-ordinate plot (PCP).....	98
4.12.4. Self organizing maps (SOM) .....	98
4.13. Performance metrics for multi-objective optimization.....	99
4.13.1. Number of nondominated points .....	100
4.13.2. Spread .....	100
4.13.3. Standard deviation of crowding distance.....	100
4.13.4. Min/Max of objectives.....	100
4.13.5. Hypervolume.....	100
4.13.6. Number of common points .....	100
4.13.7. Number of new nondominated solutions .....	101
4.13.8. Number of old dominated solutions $n(Q)$ .....	101
4.13.9. Consolidation ratio.....	101
4.13.10. Improvement ratio.....	101
4.14. Discrete optimization .....	102
4.14.1. Discrete variables.....	102
4.14.2. Discrete optimization.....	102
4.14.3. Mixed-discrete optimization.....	102
4.14.4. Discrete optimization algorithm: genetic algorithm .....	103
4.14.5. Objective function for discrete optimization .....	103
4.14.6. Sequential strategy.....	103
4.15. Summary of the optimization process.....	103
4.15.1. Convergence to an optimal point .....	104
4.16. REFERENCES .....	105
5. Applications of Optimization.....	108
5.1. Multicriteria design optimization.....	108
5.1.1. Euclidean distance function .....	108
5.1.2. Maximum distance.....	109
5.2. Multidisciplinary design optimization .....	110
5.3. System identification using nonlinear regression .....	111
5.3.1. Ordinate-based Curve Matching.....	111
5.3.2. Curve Mapping .....	112
5.3.3. Minimizing the maximum residual (Min-Max).....	116
5.3.4. Nonlinear regression: Confidence intervals.....	116
5.4. Worst-case design.....	117
5.5. Reliability-based design optimization (RBDO)* .....	119
5.6. REFERENCES .....	119
6. Probabilistic Fundamentals.....	121
6.1. Introduction.....	121
6.2. Probabilistic variables.....	121
6.2.1. Variable linking .....	122

6.3.	Basic computations .....	122
6.3.1.	Mean, variance, standard deviation, and coefficient of variation .....	122
6.3.2.	Correlation of responses .....	123
6.3.3.	Confidence intervals .....	123
6.4.	Probabilistic methods.....	124
6.4.1.	Monte Carlo simulation .....	124
6.4.2.	Monte Carlo analysis using metamodels .....	126
6.4.3.	Correlated variables .....	127
6.4.4.	First-Order Second-Moment Method (FOSM).....	127
6.4.5.	Design for six-sigma methods .....	128
6.4.6.	The most probable point .....	128
6.4.7.	FORM (First Order Reliability Method).....	130
6.4.8.	Design sensitivity of the most probable point.....	131
6.5.	Required number of simulations.....	132
6.5.1.	Overview.....	132
6.5.2.	Background.....	132
6.5.3.	Competing role of variance and bias .....	133
6.5.4.	Confidence interval on the mean .....	134
6.5.5.	Confidence interval on a new evaluation.....	134
6.5.6.	Confidence interval on the noise (stochastic process) variance.....	135
6.5.7.	Probability of observing a specific failure mode .....	136
6.6.	Outlier analysis .....	137
6.7.	Stochastic contribution analysis.....	138
6.7.1.	Linear estimation .....	138
6.7.2.	Second and higher order estimation.....	139
6.8.	Robust parameter design.....	141
6.8.1.	Fundamentals .....	141
6.8.2.	Methodology .....	142
6.8.3.	Experimental design.....	143
6.9.	REFERENCES .....	143
7.	Design Optimization Process.....	145
7.1.	A modus operandi for design using response surfaces .....	145
7.1.1.	Preparation for design.....	145
7.1.2.	A step-by-step design optimization procedure .....	147
7.2.	Recommended test procedure.....	148
7.3.	Pitfalls in design optimization .....	148
7.3.1.	Global optimality .....	148
7.3.2.	Noise.....	149
7.3.3.	Non-robust designs .....	149
7.3.4.	Impossible designs.....	149
7.3.5.	Non-unique designs .....	149
7.4.	REFERENCES .....	150
8.	Graphical User Interface and Command Language.....	151
8.1.	LS-OPT user interface (LS-OPTui).....	151
8.2.	Problem description and author name.....	152
8.3.	Command language .....	153

8.3.1. Names .....	154
8.3.2. Command lines .....	155
8.3.3. File names .....	155
8.3.4. Command file structure .....	155
8.3.5. Environments .....	155
8.3.6. Expressions .....	156
9. Program Execution.....	157
9.1. Work directory .....	157
9.2. Execution commands .....	157
9.3. Directory structure .....	157
9.4. Job monitoring .....	158
9.5. Result extraction .....	159
9.6. Restarting .....	159
9.7. Output files.....	160
9.8. Log files and status files .....	162
9.9. Managing disk space during run time .....	163
9.10. Error termination of a solver run .....	164
9.11. Parallel processing .....	164
9.12. Remote job scheduling.....	164
9.13. Using an external queuing or job scheduling system.....	165
9.13.1. Introduction.....	165
9.13.2. Installation.....	166
Installation for all remote machines running LS-DYNA.....	166
Installation on the local machine .....	167
9.13.3. Examples.....	167
9.13.4. Mechanics of the queuing process .....	171
9.13.5. Environment variables .....	173
9.13.6. Abnormal termination and retrying the job submission .....	173
User-defined abnormal termination .....	173
Queuer timeout .....	174
9.13.7. Troubleshooting .....	174
9.13.8. User-defined queuing systems .....	175
9.13.9. Blackbox queueing system .....	175
9.13.10. Honda queuing system.....	178
9.13.11. Microsoft Windows Compute Cluster server .....	180
9.14. Enabling LSTCVM job proxy support .....	181
9.14.1. LSTCVM options .....	181
9.14.2. LSTCVM server installation.....	181
9.14.3. Environment Variables .....	182
9.14.4. Configuring the <code>lstcvm_run</code> client.....	182
9.14.5. Database recovery.....	182
9.14.6. Simple manual setup for running LS-OPT and solvers on different machines .....	183
9.15. Passing environment variables through LS-OPT.....	184
9.15.1. Adding a new environment variable definition .....	185
9.15.2. Editing an existing environment variable definition.....	186
9.15.3. Set by browsing.....	186

9.15.4.	Edit browse list .....	190
9.15.5.	How the browse list is used by LSOPT .....	190
9.16.	Killing jobs.....	191
9.16.1.	Overview of How Jobs are Killed.....	191
9.16.2.	Killing Jobs using LS-OPT, LS-OPTui, and LSKILLJOB. ....	193
9.16.3.	Flagging a Job for Restart.....	198
10.	Interfacing to a Solver, Preprocessor or Postprocessor .....	200
10.1.	Parsing, copying and transmitting of LS-DYNA input and include files.....	200
10.2.	Labeling design variables in a solver and preprocessor.....	201
10.2.1.	The LS-OPT parameter format .....	202
10.3.	Interfacing to a Solver.....	204
10.3.1.	Interfacing with LS-DYNA .....	205
10.3.2.	Interfacing with LS-DYNA/MPP .....	208
10.3.3.	Interfacing with the MSC-NASTRAN <sup>®</sup> solver (SOL 103) .....	208
10.3.4.	Interfacing with a user-defined solver .....	210
10.3.5.	How to run LS-DYNA from LS-OPT using the license server (Windows).....	210
10.4.	Preprocessors .....	211
10.4.1.	LS-PREPOST .....	211
10.4.2.	LS-INGRID.....	212
10.4.3.	TrueGrid.....	212
10.4.4.	ANSA (BETA CAE Systems SA) .....	213
10.4.5.	AutoDV .....	214
10.4.6.	HyperMorph.....	215
10.4.7.	User-defined preprocessor .....	216
10.5.	Postprocessors.....	217
10.5.1.	μETA (BETA CAE Systems SA).....	218
10.5.2.	User-defined post-processor .....	219
10.6.	Extra input files.....	220
11.	Design Variables, Constants, and Dependents .....	222
11.1.	Selection of design variables .....	223
11.2.	Definition of upper and lower bounds of the design space.....	223
11.3.	Size and location of region of interest (range).....	223
11.4.	Local variables.....	224
11.5.	Discrete variables.....	224
11.6.	Assigning variable to solver.....	224
11.7.	Constants.....	225
11.8.	Dependent variables.....	225
11.9.	System variables .....	226
11.10.	Worst-case design.....	226
12.	Probabilistic Modeling and Monte Carlo Simulation .....	227
12.1.	Probabilistic problem modeling.....	227
12.2.	Probabilistic distributions .....	228
12.2.1.	Beta distribution.....	228
12.2.2.	Binomial distribution .....	229
12.2.3.	Lognormal distribution .....	229
12.2.4.	Normal distribution.....	230

12.2.5. Truncated normal distribution.....	231
12.2.6. Uniform distribution .....	232
12.2.7. User defined distribution.....	233
12.2.8. Weibull distribution .....	235
12.3. Probabilistic variables.....	236
12.3.1. Setting the nominal value of a probabilistic variable.....	237
12.3.2. Bounds on probabilistic variable values .....	238
12.3.3. Noise variable subregion size .....	238
12.3.4. Correlated variables .....	239
12.4. Probabilistic simulation .....	239
12.4.1. Monte Carlo analysis .....	239
12.4.2. Monte Carlo analysis using a metamodel .....	240
12.4.3. Accuracy of metamodel based Monte Carlo.....	241
12.4.4. Adding the noise component to metamodel Monte Carlo computations.....	242
12.4.5. FORM (First Order Reliability Method) analysis.....	242
12.5. Stochastic contribution analysis (DSA).....	243
12.6. Covariance .....	244
12.7. Robust design.....	244
13. Metamodels and Point Selection.....	246
13.1. Metamodel definition.....	246
13.1.1. Response surface methodology.....	247
13.1.2. Neural networks and radial basis function networks .....	247
13.1.3. Variability of neural networks* .....	247
13.1.4. Basis functions and optimization criterion for RBF .....	249
13.1.5. Efficiency of neural networks* .....	249
13.1.6. Kriging parameters.....	250
13.1.7. User-defined metamodel.....	250
13.2. Global sensitivity analysis .....	253
13.3. Point selection schemes .....	253
13.3.1. Overview.....	253
13.3.2. D-Optimal point selection.....	256
13.3.3. Latin Hypercube Sampling .....	257
13.3.4. Space Filling .....	257
13.3.5. Space Filling of Pareto Optimal Frontier.....	258
How to use the Pareto Optimal Frontier as a basis set for sampling .....	258
13.3.6. User-defined point selection .....	259
Comma separated variables .....	259
Free format.....	260
13.4. Sampling at discrete points .....	260
13.5. Duplicating an experimental design.....	260
13.6. Replicate experimental points.....	261
13.7. Augmentation of an existing design .....	261
13.8. Specifying an irregular design space .....	262
13.9. Automatic updating of an experimental design .....	263
13.10. Using design sensitivities for optimization.....	263
13.10.1. Analytical sensitivities.....	263

13.10.2.	Numerical sensitivities.....	264
13.11.	Checkpoints.....	265
13.12.	Metamodel Evaluation using a set of design points.....	265
13.13.	Alternative point selection.....	266
13.14.	Changing the number of points on restart*.....	267
13.15.	Repeatability of point selection.....	269
13.16.	Remarks: Point selection.....	269
14.	History and Response Results.....	270
14.1.	Defining a response history (vector).....	270
14.1.1.	Crossplot history.....	272
14.1.2.	Derivative history.....	273
14.1.3.	Filtered history.....	274
14.1.4.	History files.....	275
14.2.	Defining a response (scalar).....	275
14.3.	Specifying the metamodel type.....	276
14.4.	Extracting history and response quantities: LS-DYNA.....	277
14.5.	LS-DYNA Binout results.....	278
14.5.1.	Binout histories.....	279
14.5.2.	Binout responses.....	280
14.6.	LS-DYNA D3Plot results.....	282
14.6.1.	D3Plot histories.....	282
14.6.2.	D3Plot responses.....	284
14.7.	Mass.....	285
14.8.	Frequency and mode tracking.....	286
14.9.	Extracting metal forming response quantities: LS-DYNA.....	287
14.9.1.	Thickness and thickness reduction.....	287
14.9.2.	FLD constraint.....	288
14.9.3.	Principal stress.....	291
14.10.	Kinematics.....	291
14.11.	The GenEx application for extracting entities from a text file.....	294
14.11.1.	The main window.....	294
14.11.2.	Creating a .g6 file for LS-OPT.....	297
14.11.3.	How to use GenEx from LS-OPT for extracting responses.....	298
14.11.4.	An example using GenEx to extract responses.....	298
14.11.5.	An example using "Repeated anchor vector" to extract histories.....	306
14.11.6.	An example using "Column vector" to extract histories.....	308
14.11.7.	How to extract the histories from LS-OPT.....	309
14.12.	User-defined interface for extracting results.....	310
14.13.	Responses without metamodels.....	311
14.14.	Matrix operations.....	311
14.14.1.	Initializing a matrix.....	313
14.14.2.	Creating a rotation matrix using 3 specified points.....	313
14.15.	Injury criteria.....	314
14.16.	Head Injury Criteria.....	314
14.16.1.	HIC.....	314
14.17.	Neck Criteria.....	314

14.17.1. MOC .....	314
14.17.2. NIC (rear impact).....	316
14.17.3. Nij (Nce, Ncf, Nte, Ntf) .....	316
14.17.4. Nkm (Nfa, Nea, Nfp, Nep).....	318
14.17.5. LNL.....	320
14.18. Chest Criteria .....	321
14.18.1. Chest compression .....	321
14.18.2. Viscous criterion (VC).....	322
14.18.3. Thoracic Trauma Index (TTI).....	324
14.19. Criteria for the Lower Extremities.....	325
14.19.1. Tibia Index (TI).....	325
14.20. Additional Criteria .....	326
14.20.1. A3ms .....	326
14.21. Binout injury criteria.....	327
14.22. Virtual history .....	328
14.23. REFERENCES .....	329
15. Composite Functions .....	330
15.1. Introduction.....	330
15.1.1. Composite vs. response expressions.....	330
15.2. Expression composite .....	330
15.2.1. General expressions .....	330
15.2.2. Special expressions .....	330
15.3. Standard composite.....	331
15.3.1. Targeted composite (square root of MSE).....	331
15.3.2. Mean squared error composite.....	331
15.3.3. Weighted composite.....	331
15.4. Defining the composite function.....	332
15.5. Assigning design variable or response components to the composite.....	333
15.6. Curve Matching .....	334
15.6.1. Ordinate-based Curve Matching.....	334
15.6.2. Curve Mapping .....	338
16. Objectives and Constraints .....	340
16.1. Formulation.....	340
16.2. Defining an objective function.....	341
16.3. Defining a constraint.....	342
16.4. Bounds on the constraint functions.....	343
16.5. Minimizing the maximum response or violation* .....	344
16.6. Internal scaling of constraints .....	346
17. Running the Design Task.....	348
17.1. Optimization .....	348
17.1.1. Number of optimization iterations.....	348
17.1.2. Optimization termination criteria.....	348
17.2. Probabilistic evaluation.....	349
17.3. Restarting .....	350
17.4. Baseline run only .....	350
17.5. Omit last verification run .....	350

17.6.	Job concurrency .....	350
17.7.	Job distribution.....	350
17.8.	Job and analysis monitoring.....	351
17.9.	Pause and Resume.....	351
17.10.	Repair or modification of an existing job .....	351
17.11.	Tools .....	353
17.12.	Importing user-defined analysis results .....	354
17.13.	Saving/compressing the LS-OPT database after completing a run .....	355
18.	Viewing Results.....	356
18.1.	Viewer overview.....	356
18.1.1.	Plot Selector.....	356
18.1.2.	General Plot Options.....	357
18.1.3.	Plot Rotation .....	358
18.1.4.	Point Selection .....	359
18.1.5.	Split Window .....	361
18.1.6.	Save Plot Setup.....	362
18.1.7.	Command line options.....	363
18.1.8.	Iteration Panel.....	364
18.1.9.	Ranges.....	364
18.2.	Visualization of Simulation Results.....	365
18.2.1.	Correlation Matrix .....	365
18.2.2.	Scatter Plot.....	367
18.2.3.	Parallel Coordinate Plot.....	368
18.2.4.	History Plot.....	370
18.2.5.	Statistical Tools.....	371
18.2.6.	Correlation Bars.....	374
18.3.	Visualization of Metamodel Results.....	375
18.3.1.	Surface Plot.....	376
18.3.2.	2D Interpolator Plot .....	381
18.3.3.	Accuracy Plot.....	382
18.3.4.	Sensitivities.....	383
18.3.5.	History Plot.....	386
18.4.	Visualization of Optimization Results.....	387
18.4.1.	Optimization History .....	387
18.4.2.	Variables Plot.....	389
18.5.	Visualization of Pareto Optimal Solutions .....	390
18.5.1.	Tradeoff Plot.....	390
18.5.2.	Parallel Coordinate Plot.....	391
18.5.3.	Hyper-Radial Visualization .....	392
18.5.4.	Self-Organizing Maps.....	393
18.6.	Stochastic Analysis .....	394
18.6.1.	Statistics .....	394
18.6.2.	Correlation Bars.....	397
18.6.3.	Stochastic Contribution.....	398
18.7.	References.....	399
19.	Applications of Optimization.....	400



19.1.	Multidisciplinary design optimization (MDO)	400
19.1.1.	Command file	400
19.2.	Worst-case design	401
19.3.	Reliability-based design optimization (RBDO)*	401
20.	Optimization Algorithm Selection and Settings	402
20.1.	Introduction	402
20.2.	Selecting an optimization methodology	402
20.3.	Selecting strategies for metamodel-based optimization	403
20.3.1.	Single stage	404
20.3.2.	Sequential strategy	404
20.3.3.	Sequential strategy with domain reduction	405
20.4.	Domain reduction in metamodel-based optimization	406
20.4.1.	Setting the subdomain parameters	406
20.4.2.	Changing the behavior of the subdomain	408
20.5.	Selecting an algorithm for metamodel-based optimization	409
20.6.	Setting parameters in the LFOPC algorithm	410
20.7.	Setting parameters in the genetic algorithm	411
20.8.	Setting parameters in the simulated annealing algorithm	413
20.9.	Termination criterion for multi-objective optimizers	414
20.10.	Verification runs	416
21.	LS-DYNA Results Statistics	418
21.1.	Working with the plots	419
21.2.	Monte Carlo	420
21.3.	Metamodels and residuals	421
21.4.	Monte Carlo and metamodel analysis commands	423
21.5.	Correlation	424
21.5.1.	Correlation of fringe plots or histories with responses	424
21.5.2.	Correlation between variables	426
21.6.	Stochastic contribution of a variable (Design sensitivity analysis)	427
21.7.	Safety margin	427
21.8.	Visualization in LS-PREPOST	429
21.9.	Viewing LS-OPT histories	430
21.10.	Bifurcation investigations	432
21.10.1.	Automatic detection	433
21.10.2.	Manual detection	434
21.11.	Displacement magnitude issues*	435
21.12.	Metalfforming options	436
21.13.	Re-use and persistence of an evaluation methodology*	439
22.	Example Problems	440
22.1.	Two-bar truss (2 variables)	440
22.1.1.	Description of problem	440
22.1.2.	A first approximation using linear response surfaces	443
22.1.3.	Updating the approximation to second order	446
22.1.4.	Reducing the region of interest for further refinement	449
22.1.5.	Conducting a trade-off study	451
22.1.6.	Automating the design process	452

22.2.	Small car crash (2 variables).....	455
22.2.1.	Introduction.....	455
22.2.2.	Design criteria and design variables.....	456
22.2.3.	Design formulation.....	456
22.2.4.	Modeling.....	457
22.2.5.	First linear iteration.....	458
22.2.6.	First quadratic iteration.....	461
22.2.7.	Automated run.....	463
22.2.8.	Trade-off using neural network approximation.....	465
22.2.9.	Mixed-discrete optimization.....	467
22.2.10.	Optimization using Direct GA simulation.....	468
22.2.11.	RBDO (Reliability-based design optimization) using FOSM (First Order Second Moment Method)*.....	470
22.3.	Impact of a cylinder (2 variables).....	470
22.3.1.	Problem statement.....	471
22.3.2.	A first approximation.....	473
22.3.3.	Refining the design model using a second iteration.....	476
22.3.4.	Third iteration.....	478
22.3.5.	Response filtering: using the peak force as a constraint.....	480
22.4.	Sheet-metal forming (3 variables).....	483
22.4.1.	Problem statement.....	483
22.4.2.	First Iteration.....	485
22.4.3.	Automated design.....	492
22.5.	System identification (elastoplastic material) (2 variables).....	496
22.5.1.	Problem statement.....	496
22.5.2.	Ordinate-based Curve Matching.....	497
22.5.3.	Maximum residual formulation.....	499
22.5.4.	Results.....	502
22.5.5.	Mean Squared Error (MSE) formulation.....	502
22.5.6.	Maximum residual formulation.....	505
22.6.	Large vehicle crash and vibration (MDO/MOO) (7 variables).....	506
22.6.1.	FE Modeling.....	506
22.6.2.	Design formulation.....	508
22.6.3.	Input preparation.....	509
22.6.4.	Variable screening.....	512
22.6.5.	Optimization history results and Pareto optimal front.....	514
22.6.6.	Summary of results.....	516
22.6.7.	Multi-objective optimization using Direct GA simulation.....	520
22.7.	Knee impact with variable screening (11 variables).....	523
22.7.1.	FE modeling.....	523
22.7.2.	Design formulation.....	524
22.7.3.	Input preparation.....	525
22.7.4.	Variable screening.....	528
22.7.5.	Optimization strategy.....	530
22.7.6.	Optimization history results.....	530
22.7.7.	Summary of results.....	531

22.8.	Optimization with analytical design sensitivities .....	535
22.9.	Probabilistic Analysis .....	537
22.9.1.	Overview .....	537
22.9.2.	Problem description .....	538
22.9.3.	Monte Carlo evaluation .....	539
22.9.4.	Monte Carlo using metamodel .....	542
22.9.5.	Bifurcation analysis .....	545
22.10.	Bifurcation/Outlier Analysis .....	546
22.10.1.	Overview .....	546
22.10.2.	Problem description .....	546
22.10.3.	Automatic identification of buckling modes .....	548
22.10.4.	Manual identification of buckling modes .....	549
22.11.	Robust Parameter Design .....	552
22.12.	Using Stochastic Fields .....	554
Using only a stochastic field .....	556	
22.12.1.	A variable and a stochastic field .....	558
22.12.2.	Replicate experiments using stochastic fields .....	559
22.12.3.	Using fixed stochastic fields .....	561
22.13.	REFERENCES .....	562

# TABLE OF FIGURES

Figure 2-1: Six space-filling designs: 5 points in a 2-dimensional box region .....	43
Figure 3-1: Schematic of a neural network with 2 inputs and a hidden layer of 4 neurons with activation function $f$ .....	53
Figure 3-2: Sigmoid transfer function $y=1/(1+\exp(-x))$ typically used with feedforward networks.....	54
Figure 3-3: Radial basis transfer function $y=\exp(-x^2)$ .....	54
Figure 3-4: Weighted sum of radial basis transfer functions. Three radial basis functions (dashed lines) are scaled and summed to produce a function (solid line).....	54
Figure 3-5: A radial basis network approximation (solid line) of the function, which fits the 21 data points (plus symbols).....	54
Figure 3-6: The same 21 data points as in Figure 3-5. Test points reveal that the function has been overfit. RBF neuron's spread is too small. RBF network could have done better with a higher spread constant. ....	55
Figure 3-7: The same 21 data points as in Figure 3-5. Approximation with overlapping RBF neurons. The spread of RBF units is too high. ....	55
Figure 4-1: Adaptation of subregion in SRSM: (a) pure panning, (b) pure zooming and (c) a combination of panning and zooming.....	76
Figure 4-2: The sub-region contraction rate $\lambda$ as a function of the oscillation indicator $\hat{c}$ and the absolute move distance $ d $ .....	77
Figure 4-3: Simple genetic algorithm. ....	80
Figure 4-4: Illustration of non-domination criterion, Pareto optimal set, and Pareto optimal front. ....	86
Figure 4-5: Elitist non-dominated sorting genetic algorithm (NSGA-II). The shaded blocks are not the part of original NSGA-II but additions to avoid Pareto drift. ....	87
Figure 4-6: Elitism in NSGA-II. ....	88
Figure 4-7: Trade-off plot shows all four objectives of Pareto optimal solutions. ....	95
Figure 4-8: The Pareto frontier and indifference curves.....	96
Figure 4-9: Parallel coordinate plot shows objectives and design variables of all points on the Pareto front. ....	98
Figure 4-10: Self organizing maps display design objectives, variables, and constraints on the Pareto front. ....	99
Figure 5-1: Entities in Mean Squared Error formulation.....	112
Figure 20: Partial curve mapping of Curve a (in red) to Curve a' with offset. The result is Curve a''. The solid points represent the original vertices of a' whereas the open circles represent the mapped points representing a''. Curves a and a' are both normalized to the bounding box of a.....	114
Figure 6-1 Finding the most probable point of failure. The most probable point is the point on the line $G(x)=0$ closest to the design in the probabilistic sense.....	129
Figure 6-2 Most probable point in the transformed space. In the transformed space the most probable point is the point on the line $G(X)=0$ the closest to the origin. ....	130
Figure 6-3 Outliers are identified after a metamodel has been fitted. Values in poor agreement of what is predicted by the design variables are considered outliers.....	138
Figure 6-4 Robustness considering a single variable. Larger mean values of the area result in a smaller dispersion of the stress values. Note that the dispersion of the stress depends on the gradient of the stress-area relationship. ....	141

Figure 6-5 Robustness of a problem with both control and noise variables. The effect of the noise variable $z$ on the response variation can be constrained using the control variable $x$ . For robustness, the important property is the gradient of the response with respect to the noise variable. This gradient prescribes the noise in the response and can be controlled using the control variables. The gradient, as shown in the figure, is large for large values of the control variable. Smaller values of the control variable will therefore result in a more robust design, because of the lower gradient and accordingly less scatter in the response.....	142
Figure 8-1: Information panel in LS-OPTui.....	152
Figure 9-1 : Directory structure in LS-OPT.....	158
Figure 10-1: Solver panel in LS-OPTui.....	204
Figure 10-2: Solvers panel showing Post-processor feature.....	219
Figure 11-1: Variables panel in LS-OPTui.....	222
Figure 12-1 Beta distribution.....	228
Figure 12-2 Binomial distribution.....	229
Figure 12-3 Lognormal distribution.....	230
Figure 12-4 Normal Distribution.....	231
Figure 12-5 Truncated Normal Distribution.....	232
Figure 12-6 Uniform Distribution.....	233
Figure 12-7 User defined distribution.....	234
Figure 12-8 Weibull distribution.....	235
Figure 12-9 Probabilistic variables. The nominal value of a control variable can be adjusted by the optimization algorithm between the lower and upper bound; the probabilistic variation of a design variable is around this nominal value. A noise variable is described completely by the statistical distribution. A discrete variable, like design variable has a nominal value selected by the optimization algorithm; the probabilistic variation of the discrete variable is around this nominal value. ....	236
Figure 12-10 Metamodel-based Monte Carlo analysis. The method proceed in two steps: firstly a metamodel is created, and then the Monte Carlo simulation is done using the metamodel and the statistical distribution of the variable. Note that the metamodel for a design/control variable is constructed considering the upper and lower bound on the variable and not considering the statistical distribution. For a noise variable the upper and lower bounds for the creation of the metamodel are selected considering the statistical distribution. ....	241
Figure 13-1: Sampling panel in LS-OPT.....	246
Figure 13-2: Metamodel and Point Selection panel in LS-OPTui (Advanced options (basis experimental design) displayed).....	256
Figure 13-3: Selecting the Feedforward neural network approximation method in the Point Selection panel (Efficiency options displayed).....	258
Figure 13-4: Selecting Sensitivities in the Point Selection panel.....	264
Figure 14-1: Histories panel in LS-OPTui.....	272
Figure 14-2: Reponses panel in LS-OPTui.....	277
Figure 14-3: FLD curve – constraint definition.....	289
Figure 14-4: Local and global coordinate systems.....	293
Figure 14-5 Setting flag to create virtual histories.....	329
Figure 15-1: Definition of targeted (Root MSE) composite response in LS-OPTui.....	332
Figure 15-2: Responses panel showing a MeanSqErr selection.....	336
Figure 16-1: Objective panel in LS-OPTui with maximization selection.....	342
Figure 16-2: Constraints panel in LS-OPTui.....	343
Figure 17-1: Run panel in LS-OPTui.....	349

Figure 17-2: Repair panel .....	353
Figure 18-1: Plot Selector .....	356
Figure 18-2: Plot Selector with additional plot information .....	357
Figure 18-3: Selection for placement of new plot in the plot selector .....	357
Figure 18-4: General options .....	357
Figure 18-5: Options for printing (right) and saving (left) images .....	358
Figure 18-6: Point selection window for single (front) and multi (background) point selection .....	359
Figure 18-7: Cross-display of selected points .....	360
Figure 18-8: Example for split option .....	361
Figure 18-9: Detachable panels .....	362
Figure 18-10: Plot Selector with previously saved setups .....	363
Figure 18-11: Iteration Panel- only current iteration (left), all previous/ all iterations (middle), iteration range and step size (right) .....	364
Figure 18-12: Ranges selections .....	365
Figure 18-13: Correlation matrix with scatter plots, histograms and linear correlation coefficient .....	366
Figure 18-14: Correlation matrix, only correlation coefficients .....	366
Figure 18-15: Scatter plot in View panel in LS-OPTui. The 4 <sup>th</sup> dimension is represented by point color ..	368
Figure 18-16: Parallel Coordinate Plot with selected point .....	369
Figure 18-17: History Plot, curves colored by variable .....	370
Figure 18-18: Histories from simulations colored by variable with target curve (File history) .....	371
Figure 18-19: Histogram constructed from simulation results .....	372
Figure 18-20: Standard deviation and mean value of selected response constructed from simulation results .....	373
Figure 18-21: Probability of Mass > 0.5 with 95% confidence interval in red constructed from simulation results .....	374
Figure 18-22: Coefficient of Correlation plot with 95% confidence interval in red .....	375
Figure 23: Metamodel options .....	376
Figure 18-24: Metamodel plot showing feasible (green) and infeasible (red) points. The predicted point is shown in violet (t_hood = 4, t_bumper = 4) with the values displayed at the top left. ....	378
Figure 18-25: Metamodel plot showing point color coding for iteration numbers .....	379
Figure 18-26: Surface plot representing only the region of interest of the fourth iteration. ....	379
Figure 18-27: Plot showing isolines on the objective function as well as constraint contours and feasibility. Feasible regions are in green. Shade of red shows degree of infeasibility (number of violated constraints). Note the legend describing constraints at the top right. ....	380
Figure 18-28: Plot showing isolines and points opposite the “Points” tab. ....	380
Figure 18-29: Metamodel plot showing standard deviation of the Neural Net committee values. ....	381
Figure 18-30: Interpolator Plot with constraints (Feasible regions are in green, shade of red shows degree of infeasibility (number of violated constraints)) and predicted value (purple line) .....	382
Figure 18-31: Computed vs. Predicted plot in View panel in LS-OPTui. The points are color-coded to represent the feasibility. The largest points represent the most recent iteration. ....	383
Figure 18-32: Linear ANOVA plot in View panel in LS-OPTui, sorted .....	384
Figure 18-33: Sorted global sensitivities of all responses and composites .....	385
Figure 18-34: Predicted Histories colored by variable .....	386
Figure 18-35: Predicted History with nearest history and maximal residual .....	387
Figure 18-36: Optimization History plot of a variable – variable values (red) and subregions (blue) .....	388
Figure 18-37: Optimization History of a response – computed (red points) and predicted (black) values ..	389

Figure 18-38: Variable Plot .....	390
Figure 18-39: Tradeoff plot .....	391
Figure 18-40: Parallel Coordinate Plot for Pareto optimal solutions with selected point (purple line).....	392
Figure 18-41: Hyper-radial visualization, equal weights, points colored by variable .....	393
Figure 18-42: Selection of position for SOM .....	393
Figure 18-43: Self-Organizing Map, component plots of objectives and distance measure .....	394
Figure 18-44: Histogram constructed using metamodel together with the statistical distribution of the variables .....	395
Figure 18-45: Mean value and standard deviation constructed using metamodel together with the statistical distribution of the variables .....	396
Figure 18-46: Probability of Composite Disp > 1 with 95% confidence interval in red constructed using metamodel together with the statistical distribution of the variables .....	397
Figure 18-47: Correlation Bars evaluated on metamodel .....	398
Figure 18-48: Stochastic Contribution plot.....	399
Figure 20-1: Selection to create Pareto Optimal Front showing the available two global strategies .....	403
Figure 20-2: Single Stage strategy selected in the Strategy tab.....	404
Figure 20-3: Sequential strategy selected in Strategy tab.....	405
Figure 20-4: Sequential Strategy with Domain Reduction selected in the Strategy tab.....	406
Figure 20-5: Setting the domain reduction parameters using SRSM Advanced Settings .....	409
Figure 20-6: Selection of the LFOPC parameters.....	411
Figure 20-7: Selection of the GA parameters for creating a Pareto Optimal Frontier.....	413
Figure 20-8: Selection of the SA parameters.....	414
Figure 20-9: Termination criteria selection for multi-objective optimizers .....	415
Figure 21-1 Visualization of DYNA results statistics. After a plot has been created using the plot creation wizard, the data for the plot must be generated by running LS-OPT, following which the plot can be displayed in LS-PREPOST. An existing plot can be edited, or a bifurcation in the plot can be investigated, or the plot can be deleted. ....	420
Figure 21-2 Different types of variation that can occur in a structure. The deterministic variation, predicted using the metamodel, is due to changes in the design variable values. The process variation, not associated with change in the design variable values, shows up in the residuals of the metamodel fit.....	421
Figure 21-3 Metamodels can be used to distinguish between changes in the results due to the design variable changes and changes due to bifurcations.....	422
Figure 21-4 Correlation between X, shown in the upper left corner, and different responses Y. Different responses Y with a positive, a negative, and no correlation are shown.....	425
Figure 21-5 Viewing the correlation between an LS-DYNA response and an LS-OPT response. Additionally, the correlation between an LS-OPT history and an LS-OPT response can also be viewed... ..	426
Figure 21-6 Viewing the stochastic contribution of a single variable.....	427
Figure 21-7 The safety margin is the difference, measured in standard deviations, between the mean response and the constraint bound on the response. ....	428
Figure 21-8 Plotting a safety margin or the probability of failure requires that the bound must be specified. ....	429
Figure 21-9 The statistics viewing options. The statistics will be shown in LS-PREPOST using the FE model from the LS-DYNA job specified using the Job field. The FE models of the jobs containing the maximum and minimum values can be overlaid in order to identify bifurcations as described in Section 21.10.....	430
Figure 21-10 Viewing all the LS-OPT histories .....	431

Figure 21-11 Statistics of an LS-OPT history.....	431
Figure 21-12 The LS-OPT histories of all the LS-DYNA run can be viewed simultaneously. ....	432
Figure 21-13 Bifurcation options. The bifurcation is found by superimposing the FE models containing the maximum and minimum results. The specification of a node ID associated with the bifurcation may be required if the extreme values in the model are not caused by the bifurcation. ....	433
Figure 21-14 Viewing a bifurcation. The structure is a plate that can buckle either left or right. Three FE models are shown, and the two distinctly different solution modes are clearly visible. The creation and display of the plot containing all three models are automated in LS-OPT. ....	434
Figure 21-15 Displacement approximation scenarios. The displacement magnitude, being always larger than zero, cannot be approximated accurately around the origin if some of the displacement components can have a negative value.....	435
Figure 21-16 The displacement magnitude can depend on the alignment of the flange with the axis. The buckling will be difficult to spot if it is aligned with the position of the axis. For configuration A, the two vectors have nearly the same length, while for configuration B, they clearly have different lengths.....	436
Figure 21-17 For metal forming specify that the coordinates instead of the nodes must be followed and specify the part (blank) for which the results must be mapped. ....	437
Figure 21-18 Interpolation of metal forming results.....	437
Figure 21-19 Accuracy of of the mapping operation for element results is shown for two cases. For each case the results are shown as the element centroid results for the original mapped mesh, the element results averaged at the nodes for the original mapped mesh, and the results mapped to the nodes of the base mesh. For the first case it can be seen that the mapping accuracy is good if the mesh is sufficiently fine to consider smoothly varying results. The second case, which occur when yielding occurs in a single element, indicates a loss of information. But for this second case, the exact numerical value of the original results is not considered very accurate, so we can consider the mapped results as sufficient as long as they conserve the prediction of failure. For the second case the numerical values are mesh-dependent, so the prediction of failure is the quantity that should be mapped to another mesh.....	438
Figure 22-1: The two-bar truss example.....	440
Figure 22-2: Prediction accuracy of Weight and Stress (Iteration 1 – Linear).....	445
Figure 22-3: Prediction accuracy of Weight and Stress (Iteration 1 – Quadratic).....	448
Figure 22-4: Trade-off of stress and weight .....	452
Figure 22-5: Optimization history of design variables and responses (Linear and Quadratic) .....	455
Figure 22-6: Small car impacting a pole.....	456
Figure 22-7: Computed vs. predicted responses – Linear approximation .....	460
Figure 22-8: Computed vs. predicted responses and trade-off – Quadratic approximation .....	462
Figure 22-9: Optimization history of HIC and Intrusion .....	464
Figure 22-10: Optimization history of design variables .....	464
Figure 22-11: Response surface accuracy using neural network approximation .....	465
Figure 22-12: Experimental design points used for trade-off.....	466
Figure 22-13: Trade-off results – Small car (2 variables).....	467
Figure 22-14 Mixed-discrete variable histories. ....	468
Figure 22-15 Optimization history of mixed-discrete variable optimization using direct GA simulation. ..	470
Figure 22-16: Impacting cylinder .....	471
Figure 22-17: Deformed finite element model (time = 20ms).....	472
Figure 22-18: Prediction accuracy of Internal Energy and Rigid Wall Force (One Quadratic iteration).....	476
Figure 22-19: Prediction accuracy of Internal Energy and Rigid Wall Force (One Quadratic iteration).....	478
Figure 22-20: Optimization history of automated design (filtered force).....	482



Figure 22-21: Cylinder: Constrained rigid wall force: $F(t) < 80000$ (SAE 300Hz filtered).....	483
Figure 22-22: Parameterization of cross-section .....	484
Figure 22-23: Quarter segment of FE model: tools and blank.....	484
Figure 22-24: Optimization history of design variables and responses (automated design) .....	494
Figure 22-25: FLD diagrams of baseline and 10 <sup>th</sup> iteration.....	495
Figure 22-26: Deformed state .....	495
Figure 22-27: Sample of elastoplastic material subjected to a controlled vertical displacement.....	496
Figure 22-28: Optimization history of MSE2. The history plots comparing the response to the test data are selected by clicking near the selected iteration on the plot and then on the MeanSqErr button. ....	504
Figure 22-29: Comparison of force-displacement and data from Test1 (baseline) .....	504
Figure 22-30: Comparison of force-displacement and data from Test1 (optimum).....	505
Figure 22-31: Crash model of vehicle showing road and wall a) Undeformed b) Deformed (78ms).....	507
Figure 22-32: Structural components affected by design variables – a) Undeformed and (b) deformed (time = 72ms).....	507
Figure 22-33: Body-in-white model of vehicle in torsional vibration mode (38.7Hz).....	508
Figure 22-34: ANOVA plots for objectives and constraints. ....	513
Figure 22-35: Global sensitivity analysis of several responses for different cases. ....	513
Figure 22-36: Optimization history of scaled mass. ....	514
Figure 22-37: Optimization history of the most important variables for CRASH and NVH cases.....	515
Figure 22-38: Pareto optimal front. ....	515
Figure 22-39: Tradeoffs between scaled mass and intrusion (displacement).....	522
Figure 22-40: Typical instrument panel prepared for a "Bendix" component test.....	524
Figure 22-41: Typical major components of a knee bolster system and definition of design variables.....	524
Figure 22-42: Constraints for the knee bolster design problem.....	525
Figure 22-43: ANOVA plots for objectives and constraints of knee-bolster design problem.....	529
Figure 22-44: Global sensitivity analysis of objectives and constraints.....	529
Figure 22-45: Optimization history of objectives and maximum constraint violations. ....	531
Figure 22-46: Tube impact.....	538
Figure 22-47 Tube Buckling.....	546
Figure 22-48 Plate Buckling Example.....	547
Figure 22-49 Selecting the automated identification of a bifurcation. The user must (i) select to overlay the FE models associated with the maximum and minimum residual and (ii) chose whether the residual is the global residual or a residual at a specific node. ....	548
Figure 22-50 LS-OPT identified and displayed this bifurcation automatically using the GUI setting shown in the previous figure. ....	549
Figure 22-51 Range of z-component displacement .....	550
Figure 22-52 Index of run with maximum z-component displacement.....	550
Figure 22-53 Index of run with minimum z-component displacement .....	551
Figure 22-54 Second buckling mode .....	551
Figure 22-55 The two-bar truss problem. The problem has two variables: the thickness of the bars and the leg widths as shown. The bar thicknesses are noise variables while the leg widths are adjusted (control variables) to minimize the effect of the variation of the bar thicknesses. The maximum stress in the structure is monitored. ....	552
Figure 22-56 Contours of stress response. The flattest part of the response is when variable 'base' equals 0.5. ....	554

Figure 22-57 Optimization histories. Design variable ‘base’ is shown on the left and the standard deviation of the stress response is shown on the right. ....	554
Figure 22-58 Problem with a stochastic field. The structural problem is shown in the top. In the bottom left are sample beams with the perturbation exaggerated by a factor 100, and the corresponding histories are shown in the bottom right. ....	555
Figure 22-59 Histogram of the responses using only a stochastic field. ....	558
Figure 22-60 Plot of the responses using the thickness variable and a stochastic field.....	559
Figure 22-61 Plot of the responses using replicate experiments.....	560
Figure 22-62 Plot of the responses using the same five stochastic fields in the replicates.....	561

# 1. Introduction

In the conventional design approach, a design is improved by evaluating its response and making design changes based on experience or intuition. This approach does not always lead to the desired result, that of a ‘best’ design, since design objectives are sometimes in conflict, and it is not always clear how to change the design to achieve the best compromise of these objectives. A more systematic approach can be obtained by using an inverse process of first specifying the criteria and then computing the ‘best’ design. The procedure by which design criteria are incorporated as objectives and constraints into an optimization problem that is then solved, is referred to as optimal design.

The state of computational methods and computer hardware has only recently advanced to the level where complex nonlinear problems can be analyzed routinely. Many examples can be found in the simulation of impact problems and manufacturing processes. The responses resulting from these time-dependent processes are, as a result of behavioral instability, often highly sensitive to design changes. Program logic, as for instance encountered in parallel programming or adaptivity, may cause spurious sensitivity. Roundoff error may further aggravate these effects, which, if not properly addressed in an optimization method, could obstruct the improvement of the design by corrupting the function gradients.

Among several methodologies available to address optimization in this design environment, *response surface methodology (RSM)*, a statistical method for constructing smooth approximations to functions in a multi-dimensional space, has achieved prominence in recent years. Rather than relying on local information such as a gradient only, RSM selects designs that are optimally distributed throughout the design space to construct approximate surfaces or ‘design formulae’. Thus, the local effect caused by ‘noise’ is alleviated and the method attempts to find a representation of the design response within a bounded design space or smaller region of interest. This extraction of global information allows the designer to explore the design space, using alternative design formulations. For instance, in vehicle design, the designer may decide to investigate the effect of varying a mass constraint, while monitoring the crashworthiness responses of a vehicle. The designer might also decide to constrain the crashworthiness response while minimizing or maximizing any other criteria such as mass, ride comfort criteria, etc. These criteria can be weighted differently according to importance and therefore the design space needs to be explored more widely.

Part of the challenge of developing a design program is that designers are not always able to clearly define their design problem. In some cases, design criteria may be regulated by safety or other considerations and therefore a response has to be constrained to a specific value. These can be easily defined as mathematical constraint equations. In other cases, fixed criteria are not available but the designer knows whether the responses must be minimized or maximized. In vehicle design, for instance, crashworthiness can be constrained because of regulation, while other parameters such as mass, cost and ride comfort can be treated as objectives to be incorporated in a multi-objective optimization problem. Because the relative importance

of various criteria can be subjective, the ability to visualize the trade-off properties of one response vs. another becomes important.

Trade-off curves are visual tools used to depict compromise properties where several important response parameters are involved in the same design. They play an extremely important role in modern design where design adjustments must be made accurately and rapidly. Design trade-off curves are constructed using the principle of *Pareto* optimality. This implies that only those designs of which the improvement of one response will necessarily result in the deterioration of any other response are represented. In this sense no further improvement of a Pareto optimal design can be made: it is the best compromise. The designer still has a choice of designs but the factor remaining is the subjective choice of which feature or criterion is more important than another. Although this choice must ultimately be made by the designer, these curves can be helpful by limiting the number of possible solutions. An example in vehicle design is the trade-off between mass (or energy efficiency) and safety.

Adding to the complexity, is the fact that mechanical design is really an interdisciplinary process involving a variety of modeling and analysis tools. To facilitate this process, and allow the designer to focus on creativity and refinement, it is important to provide suitable interfacing utilities to integrate these design tools. Designs are bound to become more complex due to the legislation of safety and energy efficiency as well as commercial competition. It is therefore likely that in future an increasing number of disciplines will have to be integrated into a particular design. This approach of multidisciplinary design requires the designer to run more than one case, often using more than one type of solver. For example, the design of a vehicle may require the consideration of crashworthiness, ride comfort, noise level as well as durability. Moreover, the crashworthiness analysis may require more than one analysis case, e.g. frontal and side impact. It is therefore likely that as computers become more powerful, the integration of design tools will become more commonplace, requiring a multidisciplinary design interface.

Modern architectures often feature multiple processors and all indications are that the demand for distributed computing will strengthen into the future. This is causing a revolution in computing as single analyses that took a number of days in the recent past can now be done within a few hours. Optimization, and RSM in particular, lend themselves very well to being applied in distributed computing environments because of the low level of message passing. Response surface methodology is efficiently handled, since each design can be analyzed independently during a particular iteration. Needless to say, sequential methods have a smaller advantage in distributed computing environments than global search methods such as RSM.

The present version of LS-OPT also features Monte Carlo based point selection schemes and optimization methods. The respective relevance of stochastic and response surface based methods may be of interest. In a pure response surface based method, the effect of the variables is distinguished from chance events while Monte Carlo simulation is used to investigate the effect of these chance events. The two methods should be used in a complimentary fashion rather than substituting the one for the other. In the case of events in which chance plays a significant role, responses of design interest are often of a global nature (being averaged or integrated over time). These responses are mainly deterministic in character. The full vehicle crash example in this manual can attest to the deterministic qualities of intrusion and acceleration pulses. These types of responses may be highly nonlinear and have random components due to uncontrollable noise variables, but they are not random.

Stochastic methods have an important purpose when conducted directly or on the surrogate (approximated) design response in reliability based design optimization and robustness improvement. This methodology is currently under development and will be available in future versions of LS-OPT.

## 1.1. Overview of the manual

This LS-OPT<sup>®</sup> manual consists of three parts. In the first part, the Theoretical Manual (Chapters **2** through **6**), the theoretical background is given for the various features in LS-OPT. The next part is the User's Manual (Chapters **7** through **20**), which guides the user in the use of LS-OPT<sup>ui</sup>, the graphical user interface. These chapters also describe the command language syntax. The final part of the manual is the Examples section (Chapter **22**), where eight examples are used to illustrate the application of LS-OPT to a variety of practical applications. Appendices contain interface features (**Appendix A** and **Appendix B**), database file descriptions (**Appendix C**), a mathematical expression library (**Appendix D**), a Glossary (**Appendix E**) and a Quick Reference Manual (**Appendix**).

Sections containing advanced topics are indicated with an asterisk (\*).

*How to read this manual:*

Most users will start learning LS-OPT by consulting the User's Manual section beginning with Chapter **7** (The design optimization process). The Theoretical Manual (Chapters **2** through **6**) serves mainly as an in-depth reference section for the underlying methods. The Examples section is included to demonstrate the features and capabilities and can be read together with Chapters **7** to **22** to help the user to set up a problem formulation. The items in the Appendices are included for reference to detail, while the Quick Reference Manual provides an overview of all the features and command file syntax.

Links can be used for cross-referencing and will take the reader to the relevant item such as Section **12.4.5**, Reference **[4]** or **Figure 3-5** (just click on any of the afore-mentioned references).



# 2. Response Surface Methodology

## 2.1. Introduction

An authoritative text on Response Surface Methodology (RSM) [1] defines the method as “a collection of statistical and mathematical techniques for developing, improving, and optimizing processes.” Although an established statistical method for several decades [2], it has only recently been actively applied to mechanical design [3]. Due to the importance of weight as a criterion and the multidisciplinary nature of aerospace design, the application of optimization and RSM to design had its early beginnings in the aerospace industry. A large body of pioneering work on RSM was conducted in this and other mechanical design areas during the eighties and nineties [3]-[6]. RSM can be categorized as a Metamodeling technique (see Chapter 3 for other Metamodeling techniques namely Neural Networks, and Radial Basis Functions available in LS-OPT).

Although inherently simple, the application of response surface methods to mechanical design has been inhibited by the high cost of simulation and the large number of analyses required for many design variables. In the quest for accuracy, increased hardware capacity has been consumed by greater modeling detail and therefore optimization methods have remained largely on the periphery of the area of mechanical design. In lieu of formal methods, designers have traditionally resorted to experience and intuition to improve designs. This is seldom effective and also manually intensive. Moreover, design objectives are often in conflict, making conventional methods difficult to apply, and therefore more analysts are formalizing their design approach by using optimization.

### 2.1.1. Approximating the response

Response Surface Methodology (or RSM) requires the analysis of a predetermined set of designs. A design surface is fitted to the response values using regression analysis. Least squares approximations are commonly used for this purpose. The response surfaces are then used to construct an approximate design “subproblem” which can be optimized.

The response surface method relies on the fact that the set of designs on which it is based is well chosen. Randomly chosen designs may cause an inaccurate surface to be constructed or even prevent the ability to construct a surface at all. Because simulations are often time-consuming and may take days to run, the overall efficiency of the design process relies heavily on the appropriate selection of a design set on which to base the approximations. For the purpose of determining the individual designs, the theory of experimental design (Design of Experiments or DOE) is required. Several experimental design criteria are available but one of the most popular for an arbitrarily shaped design space is the *D*-optimality criterion. This criterion has the flexibility of allowing any number of designs to be placed appropriately in a design

space with an irregular boundary. The understanding of the  $D$ -optimality criterion requires the formulation of the least squares problem.

Consider a single response variable  $y$  dependent upon a number of variables  $\mathbf{x}$ . The exact functional relationship between these quantities is

$$y = \eta(\mathbf{x}) \quad (2-1)$$

The exact functional relationship is now approximated (e.g. polynomial approximation) as

$$\eta(\mathbf{x}) = f(\mathbf{x}) \quad (2-2)$$

The approximating function  $f$  is assumed to be a summation of basis functions:

$$f(\mathbf{x}) = \sum_{i=1}^L a_i \phi_i(\mathbf{x}) \quad (2-3)$$

where  $L$  is the number of basis functions  $\phi_i$  used to approximate the model.

The constants  $\mathbf{a} = [a_1, a_2, \dots, a_L]^T$  have to be determined in order to minimize the sum of the square error:

$$\sum_{p=1}^P \{ [y(x_p) - f(x_p)]^2 \} = \sum_{p=1}^P \left\{ \left[ y(x_p) - \sum_{i=1}^L a_i \phi_i(x_p) \right]^2 \right\} \quad (2-4)$$

$P$  is the number of experimental points and  $y$  is the exact functional response at the experimental points  $\mathbf{x}_i$ .

The solution to the unknown coefficients is:

$$\mathbf{a} = (\mathbf{X}^T \mathbf{X})^{-1} \mathbf{X}^T \mathbf{y} \quad (2-5)$$

where  $\mathbf{X}$  is the matrix

$$\mathbf{X} = [X_{ui}] = [\phi_i(x_u)] \quad (2-6)$$

The next critical step is to choose appropriate basis functions. A popular choice is the quadratic approximation

$$\phi = [1, x_1, \dots, x_n, x_1^2, x_1 x_2, \dots, x_1 x_n, \dots, x_n^2]^T \quad (2-7)$$

but any suitable function can be chosen. LS-OPT allows linear, elliptical (linear and diagonal terms), interaction (linear and off-diagonal terms) and quadratic functions.



### 2.1.2. Factors governing the accuracy of the response surface

Several factors determine the accuracy of a response surface [1].

1. *The size of the subregion*

For problems with smooth responses, the smaller the size of the subregion, the greater the accuracy. For the general problem, there is a minimum size at which there is no further gain in accuracy. Beyond this size, the variability in the response may become indistinguishable due to the presence of ‘noise’.

2. *The choice of the approximating function*

Higher order functions are generally more accurate than lower order functions. Theoretically, overfitting (the use of functions of too high complexity) may occur and result in suboptimal accuracy, but there is no evidence that this is significant for polynomials up to second order [1].

3. *The number and distribution of the design points*

For smooth problems, the prediction accuracy of the response surface improves as the number of points is increased. However, this is only true up to roughly 50% oversampling [1] (very roughly).

### 2.1.3. Advantages of the method

#### *Design exploration*

As design is a process, often requiring feedback and design modifications, designers are mostly interested in suitable design formulae, rather than a specific design. If this can be achieved, and the proper design parameters have been used, the design remains flexible and changes can still be made at a late stage before verification of the final design. This also allows multidisciplinary design to proceed with a smaller risk of having to repeat simulations. As designers are moving towards computational prototyping, and as parallel computers or network computing are becoming more commonplace, the paradigm of design exploration is becoming more important. Response surface methods can thus be used for global exploration in a parallel computational setting. For instance, interactive trade-off studies can be conducted.

#### *Global optimization*

Response surfaces have a tendency to capture globally optimal regions because of their smoothness and global approximation properties. Local minima caused by noisy response are thus avoided.

### 2.1.4. Other types of response surfaces

Neural and Radial Basis Function networks and Kriging approximations can also be used as response surfaces and are discussed under the heading of *metamodels* in Sections 3.1 and 3.2.

## 2.2. Experimental design

Experimental design is the selection procedure for finding the points in the design space that must be analyzed. Many different types are available [1]. The factorial, Koshal, composite, *D*-optimal and Latin Hypercube designs are detailed here.

### 2.2.1. Factorial design

This is a  $l^n$  grid of designs and forms the basis of many other designs.  $l$  is the number of grid points in one dimension. It can be used as a basis set of experiments from which to choose a  $D$ -optimal design. In LS-OPT, the  $3^n$  and  $5^n$  designs are used by default as the basis experimental designs for first and second order  $D$ -optimal designs respectively.

Factorial designs may be expensive to use directly, especially for a large number of design variables.

### 2.2.2. Koshal design

This family of designs is saturated for modeling of any response surface of order  $d$ .

#### *First order model*

For  $n = 3$ , the coordinates are:

$$\begin{array}{c} x_1 \quad x_2 \quad x_3 \\ \begin{bmatrix} 0 & 0 & 0 \\ 1 & 0 & 0 \\ 0 & 1 & 0 \\ 0 & 0 & 1 \end{bmatrix} \end{array}$$

As a result, four coefficients can be estimated in the linear model

$$\phi = [1, x_1, \dots, x_n]^T \quad (2-8)$$

#### *Second order model*

For  $n = 3$ , the coordinates are:

$$\begin{array}{c} x_1 \quad x_2 \quad x_3 \\ \begin{bmatrix} 0 & 0 & 0 \\ 1 & 0 & 0 \\ 0 & 1 & 0 \\ 0 & 0 & 1 \\ -1 & 0 & 0 \\ 0 & -1 & 0 \\ 0 & 0 & -1 \\ 1 & 1 & 0 \\ 1 & 0 & 1 \\ 0 & 1 & 1 \end{bmatrix} \end{array}$$

As a result, ten coefficients can be estimated in the quadratic model

$$\phi = [1, x_1, \dots, x_n, x_1^2, x_1x_2, \dots, x_1x_n, \dots, x_n^2]^T \quad (2-9)$$

### 2.2.3. Central composite design

This design uses the  $2^n$  factorial design, the center point, and the ‘face center’ points and therefore consists of  $P = 2^n + 2n + 1$  experimental design points. For  $n = 3$ , the coordinates are:

$$\begin{matrix} & x_1 & x_2 & x_3 \\ \begin{bmatrix} 0 & 0 & 0 \\ \alpha & 0 & 0 \\ 0 & \alpha & 0 \\ 0 & 0 & \alpha \\ -\alpha & 0 & 0 \\ 0 & -\alpha & 0 \\ 0 & 0 & -\alpha \\ -1 & -1 & -1 \\ 1 & -1 & -1 \\ -1 & 1 & -1 \\ -1 & -1 & 1 \\ 1 & 1 & -1 \\ 1 & -1 & 1 \\ -1 & 1 & 1 \\ 1 & 1 & 1 \end{bmatrix} \end{matrix}$$

The points are used to fit a second-order function. The value of  $\alpha = \sqrt[4]{2^n}$ .

### 2.2.4. D-optimal design

This method uses a subset of all the possible design points as a basis to solve  $\max |X^T X|$ . The subset is usually selected from an  $l^n$ -factorial design where  $l$  is chosen a priori as the number of grid points in any particular dimension. Design regions of irregular shape, and any number of experimental points, can be considered [7]. The experiments are usually selected within a sub-region in the design space thought to contain the optimum. A genetic algorithm is used to solve the resulting discrete maximization problem. See References [1] and [5].

The numbers of required experimental designs for linear as well as quadratic approximations are summarized in the table below. The value for the D-optimality criterion is chosen to be 1.5 times the Koshal design value plus one. This seems to be a good compromise between prediction accuracy and computational

cost [7]. The factorial design referred to below is based on a regular grid of  $2^n$  points (linear) or  $3^n$  points (quadratic).

**Table 2-1: Number of experimental points required for experimental designs**

Number of Variables $n$	Linear approximation			Quadratic approximation			Central Composite
	Koshal	$D$ -optimal	Factorial	Koshal	$D$ -optimal	Factorial	
1	2	4	2	3	5	3	3
2	3	5	4	6	10	9	9
3	4	7	8	10	16	27	15
4	5	8	16	15	23	81	25
5	6	10	32	21	32	243	43
6	7	11	64	28	43	729	77
7	8	13	128	36	55	2187	143
8	9	14	256	45	68	6561	273
9	10	16	512	55	83	19683	531
10	11	17	1024	66	100	59049	1045

### 2.2.5. Latin Hypercube Sampling (LHS)

The Latin Hypercube design is a constrained random experimental design in which, for  $n$  points, the range of each design variable is subdivided into  $n$  non-overlapping intervals on the basis of equal probability. One value from each interval is then selected at random with respect to the probability density in the interval. The  $n$  values of the first value are then paired randomly with the  $n$  values of variable 2. These  $n$  pairs are then combined randomly with the  $n$  values of variable 3 to form  $n$  triplets, and so on, until  $k$ -tuplets are formed.

Latin Hypercube designs are independent of the mathematical model of the approximation and allow estimation of the main effects of all factors in the design in an unbiased manner. On each level of every design variable only one point is placed. There are the same number of levels as points, and the levels are assigned randomly to points. This method ensures that every variable is represented, no matter if the response is dominated by only a few ones. Another advantage is that the number of points to be analyzed can be directly defined. Let  $P$  denote the number of points, and  $n$  the number of design variables, each of which is uniformly distributed between 0 and 1. Latin hypercube sampling (LHS) provides a  $P$ -by- $n$  matrix  $\mathbf{S} = S_{ij}$  that randomly samples the entire design space broken down into  $P$  equal-probability regions:

$$S_{ij} = (\eta_{ij} - \zeta_{ij}) / P, \tag{2-10}$$

where  $\eta_{1j}, \dots, \eta_{Pj}$  are uniform random permutations of the integers 1 through  $P$  and  $\zeta_{ij}$  independent random numbers uniformly distributed between 0 and 1. A common simplified version of LHS has centered points of  $P$  equal-probability sub-intervals:

$$S_{ij} = (\eta_{ij} - 0.5)/P \quad (2-11)$$

LHS can be thought of as a stratified Monte Carlo sampling. Latin hypercube samples look like random scatter in any bivariate plot, though they are quite regular in each univariate plot. Often, in order to generate an especially good space filling design, the Latin hypercube point selection  $\mathbf{S}$  described above is taken as a starting experimental design and then the values in each column of matrix  $\mathbf{S}$  is permuted so as to optimize some criterion. Several such criteria are described in the literature.

### ***Maxi-min***

One approach is to maximize the minimal distance between any two points (i.e. between any two rows of  $\mathbf{S}$ ). This optimization could be performed using, for example, Adaptive Simulated Annealing (see Section 4.10). The *maximin* strategy would ensure that no two points are too close to each other. For small  $P$ , *maximin* distance designs will generally lie on the exterior of the design space and fill in the interior as  $P$  becomes larger. See Section 2.2.6 for more detail.

### ***Centered L2-discrepancy***

Another strategy is to minimize the centered L2-discrepancy measure. The discrepancy is a quantitative measure of non-uniformity of the design points on an experimental domain. Intuitively, for a uniformly distributed set in the  $n$ -dimensional cube  $I^n = [0,1]^n$ , we would expect the same number of points to be in all subsets of  $I^n$  having the same volume. Discrepancy is defined by considering the number of points in the subsets of  $I^n$ . Centered L2 (CL2) takes into account not only the uniformity of the design points over the  $n$ -dimensional box region  $I^n$ , but also the uniformity of all the projections of points over lower-dimensional subspaces:

$$CL_2^2 = (13/12)^n - \frac{2}{P} \sum_{i=1 \dots P} \prod_{j=1 \dots n} \left( 1 + \frac{|S_{ij} - 0.5|}{2} - \frac{|S_{ij} - 0.5|^2}{2} \right) + \frac{1}{P_2} \sum_{k=1 \dots P} \sum_{i=1 \dots P} \prod_{j=1 \dots n} \left( 1 + \frac{|S_{kj} - 0.5|}{2} + \frac{|S_{ij} - 0.5|}{2} - \frac{|S_{kj} - S_{ij}|}{2} \right). \quad (2-12)$$

## **2.2.6. Space-filling designs**

In the modeling of an unknown nonlinear relationship, when there is no persuasive parametric regression model available, and the constraints are uncertain, one might believe that a good experimental design is a set of points that are uniformly scattered on the experimental domain (design space). *Space-filling* designs impose no strong assumptions on the approximation model, and allow a large number of levels for each variable with a moderate number of experimental points. These designs are especially useful in conjunction with nonparametric models such as neural networks (feedforward networks, radial basis functions) and Kriging, [8], [9]. Space-filling points can also be submitted as the basis set for constructing an optimal ( $D$ -Optimal, etc.) design for a particular model (e.g. polynomial). Some space-filling designs are: random Latin Hypercube Sampling (LHS), Orthogonal Arrays, and Orthogonal Latin Hypercubes.

The key to space-filling experimental designs is in generating 'good' random points and achieving reasonably uniform coverage of sampled volume for a given (user-specified) number of points. In practice, however, we can only generate finite pseudo-random sequences, which, particularly in higher dimensions, can lead to a clustering of points, limiting their uniformity. To find a good space-filling design is a nonlinear programming hard problem, which – from a theoretical point of view – is difficult to solve exactly. This problem, however, has a representation, which might be within the reach of currently available tools. To reduce the search time and still generate good designs, the popular approach is to restrict the search within a subset of the general space-filling designs. This subset typically has some good 'built-in' properties with respect to the uniformity of a design.

The constrained randomization method termed Latin Hypercube Sampling (LHS) and proposed in [10], has become a popular strategy to generate points on the 'box' (hypercube) design region. The method implies that on each level of every design variable only one point is placed, and the number of levels is the same as the number of runs. The levels are assigned to runs either randomly or so as to optimize some criterion, e.g. so that the minimal distance between any two design points is maximized ('maximin distance' criterion). Restricting the design in this way tends to produce better Latin hypercubes. However, the computational cost of obtaining these designs is high. In multidimensional problems, the search for an optimal Latin hypercube design using traditional deterministic methods (e.g. the optimization algorithm described in [11]) may be computationally prohibitive. This situation motivates the search for alternatives.

Probabilistic search techniques, *adaptive simulated annealing* and genetic algorithms are attractive heuristics for approximating the solution to a wide range of optimization problems. In particular, these techniques are frequently used to solve combinatorial optimization problems, such as the traveling salesman problem. Morris and Mitchell [12] adopted the simulated annealing algorithm to search for optimal Latin hypercube designs.

In LS-OPT, space-filling designs can be useful for constructing experimental designs for the following purposes:

1. The generation of basis points for the  $D$ -optimality criterion. This avoids the necessity to create a very large number of basis points using e.g. the full factorial design for large  $n$ . E.g. for  $n=20$  and 3 points per variable, the number of points =  $3^{20} \approx 3.5 \cdot 10^9$ .
2. The generation of design points for all approximation types, but especially for neural networks and Kriging.
3. The augmentation of an existing experimental design. This means that points can be added for each iteration while maintaining uniformity and equidistance with respect to pre-existing points.

LS-OPT contains 6 algorithms to generate space-filling designs (see Table 2-2). Only Algorithm 5 has been made available in the graphical interface. LS-OPTui.

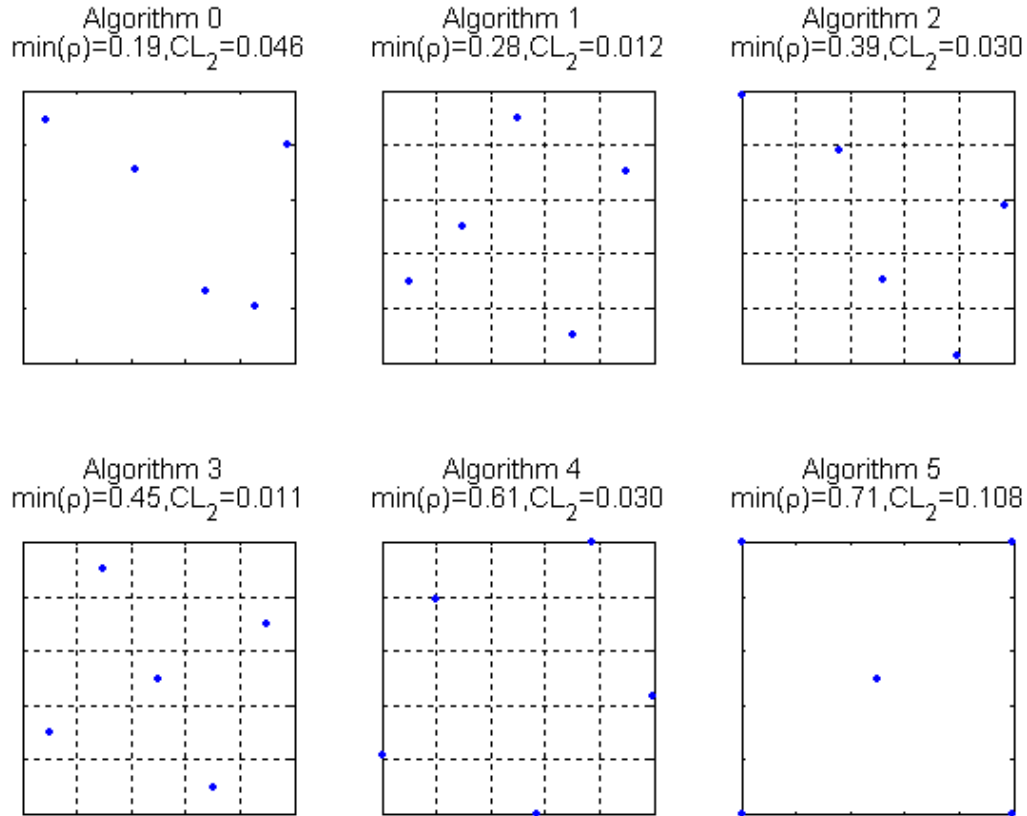


Figure 2-1: Six space-filling designs: 5 points in a 2-dimensional box region

Table 2-2: Description of space-filling algorithms

Algorithm Number	Description
0	Random
1	'Central point' Latin Hypercube Sampling (LHS) design with random pairing
2	'Generalized' LHS design with random pairing
3	Given an LHS design, permutes the values in each column of the LHS matrix so as to optimize the maximin distance criterion taking into account a set of existing (fixed) design points. This is done using <i>simulated annealing</i> . Fixed points influence the maximin distance criterion, but are not allowed to be changed by Simulated Annealing moves.
4	Given an LHS design, moves the points within each LHS subinterval preserving the starting LHS structure, optimizing the maximin distance criterion and taking into consideration a set of fixed points.
5	Given an arbitrary design (and a set of fixed points), randomly moves the points so as to optimize the maximin distance criterion using simulated

	annealing (see 4.10).
--	-----------------------

## Discussion of algorithms

The Maximin distance space-filling algorithms 3, 4 and 5 minimize the energy function defined as the negative minimal distance between any two design points. Theoretically, any function that is a metric can be used to measure distances between points, although in practice the Euclidean metric is usually employed.

The three algorithms, 3, 4 and 5, differ in their selection of random Adaptive Simulated Annealing moves from one state to a neighboring state. For algorithm 3, the next design is always a 'central point' LHS design (Eq. 2.21). The algorithm swaps two elements of  $I$ ,  $S_{ij}$  and  $S_{kj}$ , where  $i$  and  $k$  are random integers from 1 to  $N$ , and  $j$  is a random integer from 1 to  $n$ . Each step of algorithm 4 makes small random changes to a LHS design point preserving the initial LHS structure. Algorithm 5 transforms the design completely randomly - one point at a time. In more technical terms, algorithms 4 and 5 generate a candidate state,  $S'$ , by modifying a randomly chosen element  $S_{ij}$  of the current design,  $S$ , according to:

$$S'_{ij} = S_{ij} + \xi \quad (2-13)$$

where  $\xi$  is a random number sampled from a normal distribution with zero mean and standard deviation  $\sigma_\xi \in [\sigma_{\min}, \sigma_{\max}]$ . In algorithm 4 it is required that both  $S'_{ij}$  and  $S_{ij}$  in Eq. (2.23) belong to the same Latin hypercube subinterval.

Notice that maximin distance energy function does not need to be completely recalculated for every iterative step of simulated annealing. The perturbation in the design applies only to some of the rows and columns of  $S$ . After each step we can recompute only those nearest neighbor distances that are affected by the stepping procedures described above. This reduces the calculation and increased the speed of the algorithm.

To perform an annealing run for the algorithms 3, 4 and 5, the values for  $T_{\max}$  and  $T_{\min}$  can be adapted to the scale of the objective function according to:

$$T_{\max} := T_{\max} \times \Delta E, \quad T_{\min} := T_{\min} \times \Delta E \quad (2-14)$$

where  $\Delta E > 0$  is the average value of  $|E' - E|$  observed in a short preliminary run of simulated annealing and  $T_{\max}$  and  $T_{\min}$  are positive parameters.

The basic parameters that control the adaptive simulated annealing in algorithms 3, 4 and 5 can be summarized as follows:

1. Energy function: negative minimal distance between any two points in the design.
2. Stepping scheme: depends on whether the LHS property is preserved or not.
3. Scalar parameters:
  - Parameters for the cooling schedule:
  - scaling factor for the initial (maximal) temperature,  $T_{\max}$ ,



- scaling factor for the minimal temperature,  $T_{min}$ ,
- ratio of cost temperature and the parameter temperatures,
- number of iterations at each temperature,  $v_T$ .
- parameter temperature update interval
- Parameters that control the standard deviation of  $\xi$  in (2.13):
- upper bound,  $\sigma_{max}$ ,
- lower bound,  $\sigma_{min}$ .
- Termination criteria: ○  
maximal number of energy function evaluations,  $N_{it}$ .

### 2.2.7. Random number generator

The Mersenne Twister [13] is used in Neural Network construction and Monte Carlo, Latin Hypercube, Space Filling and  $D$ -Optimal point selection and probabilistic analysis. The Mersenne Twister (MT19937) is a pseudo-random number generator developed by Matsumoto and Nishimura and has the merit that it has a far longer period and far higher order of equi-distribution than any other implemented generators. It has been proved that the period is  $2^{19937}-1$ , and a 623-dimensional equi-distribution property is assured. Features have been provided to seed the generator to enable sensitivity studies.

### 2.2.8. Reasonable experimental designs

A ‘reasonable’ design space refers to a region of interest which, in addition to having specified bounds on the variables, is also bounded by specified values of the responses. This results in an irregular shape of the design space.

In LS-OPT, constrained experimental designs can be obtained for the  $D$ -Optimality criterion as well as for Space Filling.

Reasonable experimental designs can only be obtained using explicit constraints, i.e. constraints which are not defined by a metamodel.

## 2.3. Model adequacy checking

As indicated in the previous sections, response surfaces are useful for interactive trade-off studies. For the trade-off surface to be useful, its capability of predicting accurate response must be known. Error analysis is therefore an important aspect of using response surfaces in design. Inaccuracy is not always caused by random error (noise) only, but modeling error (sometimes called bias error), especially in a large subregion or where there is strong non-linearity present, could play a very significant role. There are several error measures available to determine the accuracy of a response surface.

### 2.3.1. Residual sum of squares

For the predicted response  $\hat{y}_i$  and the actual response  $y_i$ , this error is expressed as

$$\varepsilon^2 = \sum_{i=1}^P (y_i - \hat{y}_i)^2 \quad (2-15)$$

If applied only to the regression points, this error measure is not very meaningful unless the design space is oversampled e.g.,  $\varepsilon = 0$  if the number of points  $P$  equals the number of basis functions  $L$  in the approximation.

### 2.3.2. RMS error

The residual sum-of-squares is sometimes used in its square root form,  $\varepsilon_{RMS}$ , and called the ‘‘RMS error’’:

$$\varepsilon_{RMS} = \sqrt{\frac{1}{P} \sum_{i=1}^P (y_i - \hat{y}_i)^2} \quad (2-16)$$

### 2.3.3. Maximum residual

This is the maximum residual considered over all the design points and is given by

$$\varepsilon_{\max} = \max |y_i - \hat{y}_i|. \quad (2-17)$$

### 2.3.4. Prediction error

The same as the RMS error, but using only responses at preselected prediction points independent of the regression points. This error measure is an objective measure of the prediction accuracy of the response surface since it is independent of the number of construction points. It is important to know that the choice of a larger number of construction points will, for smooth problems, diminish the prediction error.

The prediction points can be determined by adding rows to  $\mathbf{X}$

$$\mathbf{X}_a(x_p) = \begin{bmatrix} \mathbf{X} \\ \mathbf{A}(x_p) \end{bmatrix} \quad (2-18)$$

and solving

$$\max |\mathbf{X}_a^T \mathbf{X}_a| = \max |\mathbf{X}^T \mathbf{X} + \mathbf{A}^T \mathbf{A}| \quad (2-19)$$

for  $x_p$ .

### 2.3.5. PRESS residuals

The prediction sum of squares residual (PRESS) uses each possible subset of  $P - 1$  responses as a regression data set, and the remaining response in turn is used to form a prediction set [1]. PRESS can be computed from a single regression analysis of all  $P$  points.

$$PRESS = \sum_{i=1}^P \left( \frac{y_i - \hat{y}_i}{1 - h_{ii}} \right)^2, \quad (2-20)$$

where  $h_{ii}$  are the diagonal terms of

$$\mathbf{H} = \mathbf{X}(\mathbf{X}^T \mathbf{X})^{-1} \mathbf{X}^T. \quad (2-21)$$

$\mathbf{H}$  is the “hat” matrix, the matrix that maps the observed responses to the fitted responses, i.e.

$$\hat{\mathbf{y}} = \mathbf{H}\mathbf{y}. \quad (2-22)$$

The PRESS residual can also be written in its square root form

$$SPRESS = \sqrt{\frac{1}{P} \sum_{i=1}^P \left( \frac{y_i - \hat{y}_i}{1 - h_{ii}} \right)^2}. \quad (2-23)$$

For a saturated design,  $\mathbf{H}$  equals the unit matrix  $\mathbf{I}$  so that the PRESS indicator becomes undefined.

### 2.3.6. The coefficient of multiple determination $R^2$

The coefficient of determination  $R^2$  is defined as:

$$R^2 = \frac{\sum_{i=1}^P (\hat{y}_i - \bar{y})^2}{\sum_{i=1}^P (y_i - \bar{y})^2} \quad (2-24)$$

where  $P$  is the number of design points and  $\bar{y}$ ,  $\hat{y}_i$  and  $y_i$  represent the mean of the responses, the predicted response, and the actual response, respectively. This indicator, which varies between 0 and 1, represents the ability of the response surface to identify the variability of the design response. A low value of  $R^2$  usually means that the region of interest is either too large or too small and that the gradients are not trustworthy. The value of 1.0 for  $R^2$  indicates a perfect fit. However, the value will not warn against an overfitted model with poor prediction capabilities.

### 2.3.7. $R^2$ for Prediction

For the purpose of *prediction* accuracy the  $R^2_{prediction}$  indicator has been devised [1].

$$R^2_{prediction} = 1 - \frac{PRESS}{S_{yy}}, \quad (2-25)$$

where

$$S_{yy} = \mathbf{y}^T \mathbf{y} - \frac{1}{P} \left( \sum_{i=1}^P y_i \right)^2. \quad (2-26)$$

$R_{prediction}^2$  represents the ability of the model to detect the variability in predicting new responses [1].

### 2.3.8. Iterative design and prediction accuracy

In an iterative scheme with a shrinking region the  $R^2$  value tends to be small at the beginning, then approaches unity as the region of interest shrinks, thereby indicating improvement of the modeling ability. It may then reduce again as the noise starts to dominate in a small region causing the variability to become indistinguishable. In the same progression, the prediction error will diminish as the modeling error fades, but will stabilize at above zero as the modeling error is replaced by the random error (noise).

## 2.4. ANOVA

Since the number of regression coefficients determines the number of simulation runs, it is important to remove those coefficients or variables which have small contributions to the design model. This can be done by doing a preliminary study involving a design of experiments and regression analysis. The statistical results are used in an analysis of variance (ANOVA) to rank the variables for screening purposes. The procedure requires a single iteration using polynomial regression, but results are produced after every iteration of a normal optimization procedure.

### 2.4.1. The confidence interval of the regression coefficients

The  $100(1 - \alpha)\%$  confidence interval for the regression coefficients  $b_j \wedge j = 0, 1, \dots, L$  is determined by the inequality

$$b_j - 0.5\Delta b_j \leq \beta_j \leq b_j + 0.5\Delta b_j, \quad (2-27)$$

where

$$\Delta b_j(\alpha) = 2t_{\alpha/2, P-L} \sqrt{\hat{\sigma}^2 C_{jj}}, \quad (2-28)$$

and  $\hat{\sigma}^2$  is an unbiased estimator of the variance  $\sigma^2$  given by

$$\hat{\sigma}^2 = \frac{\epsilon^2}{P-L} = \frac{\sum_{i=1}^P (y_i - \hat{y}_i)^2}{P-L} \quad (2-29)$$

$C_{jj}$  is the diagonal element of  $(\mathbf{X}^T \mathbf{X})^{-1}$  corresponding to  $b_j$  and  $t_{\alpha/2, P-L}$  is Student's  $t$ -Distribution.  $100(1 - \alpha)\%$  therefore represents the level of confidence that  $b_j$  will be in the computed interval.

### 2.4.2. The significance of a regression coefficient $b_j$

The contribution of a single regressor variable to the model can also be investigated. This is done by means of the *partial F*-test where  $F$  is calculated to be

$$F = \frac{[\varepsilon_{reduced}^2 - \varepsilon_{complete}^2] / r}{\varepsilon_{complete}^2 / (P - L)} \quad (2-30)$$

where  $r = 1$  and the reduced model is the one in which the regressor variable in question has been removed. Each of the  $\varepsilon^2$  terms represents the sum of squared residuals for the reduced and complete models respectively.

It turns out that the computation can be done without analyzing a reduced model by computing

$$F = \frac{b_j^2 / C_{jj}}{\varepsilon_{complete}^2 / (P - L)} \quad (2-31)$$

$F$  can be compared with the  $F$ -statistic  $F_{\alpha,1,P-L}$  so that if  $F > F_{\alpha,1,P-L}$ ,  $\beta_j$  is non-zero with  $(100 - \alpha)\%$  confidence. The confidence level  $\alpha$  that  $\beta_j$  is not zero can also be determined by computing the  $\alpha$  for  $F = F_{\alpha,1,P-L}$ . The importance of  $\beta_j$  is therefore estimated by both the magnitude of  $b_j$  as well as the level of confidence in a non-zero  $\beta_j$ .

The significance of regressor variables may be represented by a bar chart of the magnitudes of the coefficients  $b_j$  with an error bar of length  $2\Delta b_j(\alpha)$  for each coefficient representing the confidence interval for a given level of confidence  $\alpha$ . The relative bar lengths allow the analyst to estimate the importance of the variables and terms to be included in the model while the error bars represent the contribution to noise or poorness of fit by the variable.

All terms have been normalized to the size of the design space so that the choice of units becomes irrelevant and a reasonable comparison can be made for variables of different kinds, e.g. sizing and shape variables or different material constants.

## 2.5. REFERENCES

- [1] Myers, R.H., Montgomery, D.C. *Response Surface Methodology. Process and Product Optimization using Designed Experiments*. Wiley, 1995.
- [2] Box, G.E.P., Draper, N.R. A basis for the selection of a response surface design. *Journal of the American Statistical Association*, 54, pp. 622-654, 1959.
- [3] Toropov, V.V. Simulation approach to structural optimization. *Structural Optimization*, 1, pp. 37-46, 1989.
- [4] Schoofs, A.J.G. *Experimental Design and Structural Optimization*. PhD thesis, Technische Universiteit Eindhoven, August 1987.

- [5] Tu, J. and Choi, K.K. Design potential concept for reliability-based design optimization. *Technical Report R99-07. Center for Computer Aided Design and Department of Mechanical Engineering.* College of engineering. University of Iowa. December 1999.
- [6] Jin, R., Chen, W. and Simpson, T.W. Comparative studies of metamodeling techniques under multiple modeling criteria. *AIAA Paper*, AIAA-2000-4801.
- [7] Roux, W.J. *Structural Optimization using Response Surface Approximations*. PhD thesis, University of Pretoria, April 1997.
- [8] Wilson, B., Cappelleri, D.J., Frecker, M.I. and Simpson, T.W. Efficient Pareto frontier exploration using surrogate approximations. *Optimization and Engineering*, 2 (1), pp.31-50, 2001.
- [9] Ye, K., Li, W., Sudjianto, A., Algorithmic construction of optimal symmetric Latin hypercube designs. *Journal of Statistical Planning and Inferences*, 90, pp. 145-159, 2000.
- [10] McKay, M.D., Conover, W.J., Beckman, R.J. A comparison of three methods for selecting values of input variables in the analysis of output from a computer code. *Technometrics*, pp. 239-245, 1979.
- [11] Park, J.-S. Optimal Latin-hypercube designs for computer experiments. *Journal of Statistical Planning Inference*, 39, pp. 95-111, 1994.
- [12] Morris, M., Mitchell, T. Exploratory design for computer experiments. *Journal of Statistical Planning Inference*, 43, pp. 381-402, 1995.
- [13] Matsumoto, M. and Nishimura, T., Mersenne Twister: A 623-Dimensionally equidistributed uniform pseudo-random number generator. *ACM Transactions on Modeling and Computer Simulation*, 8(1), pp. 3-30, 1998.

# 3. Metamodeling Techniques

Metamodeling techniques allow the construction of surrogate design models for the purpose of design exploration such as variable screening, optimization and reliability. LS-OPT provides the capability of using three types of metamodeling techniques, namely polynomial response surfaces (already discussed, see Section 2.1), Neural Networks (NN) (Section 3.1.2) and Radial Basis Function Networks (RBF) (Section 3.1.3). All three of these approaches can be useful to provide a predictive capability for optimization or reliability. In addition, linear polynomials, although perhaps less accurate, are highly suitable for variable screening (Section 2.4). At the core, these techniques differ in the regression methods employed to construct the surrogate models. The polynomial response surface method and the RBF's use linear regression, while neural networks use nonlinear regression methods requiring an optimization algorithm.

When using polynomials, the user is faced with the choice of deciding which monomial terms to include. In addition, polynomials, by way of their nature as Taylor series approximations, are not natural for the creation of updateable surfaces. This means that if an existing set of point data is augmented by a number of new points which have been selected in a local subregion (e.g. in the vicinity of a predicted optimum), better information could be gained from a more flexible type of approximation that will keep global validity while allowing refinement in a subregion of the parameter space. Such an approximation would provide a more natural approach for combining the results of successive iterations.

## 3.1. Neural networks

Neural methods are natural extensions and generalizations of regression methods. Neural networks have been known since the 1940's, but it took the dramatic improvements in computers to make them practical, [3]. Neural networks - just like regression techniques - model relationships between a set of input variables and an outcome. Neural networks can be thought of as computing devices consisting of numerical units ('neurons'), whose inputs and outputs are linked according to specific topologies (see the example in Figure 3-1). A neural model is defined by its free parameters - the inter-neuron connection strengths ('weights') and biases. These parameters are typically 'learned' from the training data by using an appropriate optimization algorithm. The training set consists of pairs of input (design) vectors and associated outputs (responses). The training algorithm tries to steer network parameters towards minimizing some distance measure, typically the mean squared error (MSE) of the model computed on the training data.

Several factors determine the predictive accuracy of a neural network approximation and, if not properly addressed, may adversely affect the solution. For a neural network, as well as for any other data-derived model, the most critical factor is the quality of training data. In practical cases, we are limited to a given data set, and the central problem is that of not enough data. The minimal number of data points required for network training is related to the (unknown) complexity of the underlying function and the dimensionality of design space. In reality, the more design variables, the more training samples are required. In the statistical and neural network literature this problem is known as the ‘curse of dimensionality’. Most forms of neural networks (in particular, feedforward networks) actually suffer less from the curse of dimensionality than some other methods, as they can concentrate on a lower-dimensional section of the high-dimensional space. For example, by setting the outgoing weights from a particular input to zero, a network can entirely ignore that input – see Figure 3-1. Nevertheless, the curse of dimensionality is still a problem, and the performance of a network can certainly be improved by eliminating unnecessary input variables.

It is clear that if the number of network free parameters is sufficiently large and the training optimization algorithm is run long enough, it is possible to drive the training MSE error as close as one likes to zero. However, it is also clear that driving MSE all the way to zero is not a desirable thing to do. For noisy data, this may indicate over-fitting rather than good modeling. For highly discrepant training data, zero MSE makes no sense at all. Regularization means that some constraints are applied to the construction of the neural model with the goal of reducing the ‘generalization error’, that is, the ability to predict (interpolate) the unobserved response for new data points that are generated by a similar mechanism as the observed data. A fundamental problem in modeling noisy and/or incomplete data is to balance the ‘tightness’ of the constraints with the ‘goodness of fit’ to the observed data. This tradeoff is called the *bias-variance tradeoff* in the statistical literature.

A multilayer *feedforward network* and a *radial basis function network* are the two most common neural architectures used for approximating functions. Networks of both types have a distinct layered topology in the sense that their processing units (‘neurons’) are divided into several groups (‘layers’), the outputs of each layer of neurons being the inputs to the next layer (Figure 3-1).

In a feedforward network, each neuron performs a biased weighted sum of their inputs and passes this value through a transfer (activation) function to produce the output. Activation function of intermediate (‘hidden’) layers is generally a Sigmoidal function (Figure 3-2), while network input and output layers are usually linear (transparent). In theory, such networks can model functions of almost arbitrary complexity, see [4] and [5]. All parameters in a feedforward network are usually determined at the same time as part of a single (non-linear) optimization strategy based on the standard gradient algorithms (the steepest descent, RPROP, Levenberg-Marquardt, etc.). The gradient information is typically obtained using a technique called backpropagation, which is known to be computationally effective [6]. For feedforward networks, regularization may be done by controlling the number of network weights (‘model selection’), by imposing penalties on the weights (‘ridge regression’) [7], or by various combinations of these strategies [8].

A radial basis function network has a single hidden layer of radial units, each actually modeling a response function, peaked at the center, and monotonically varying outwards (Figure 3-3). Each unit responds (non-

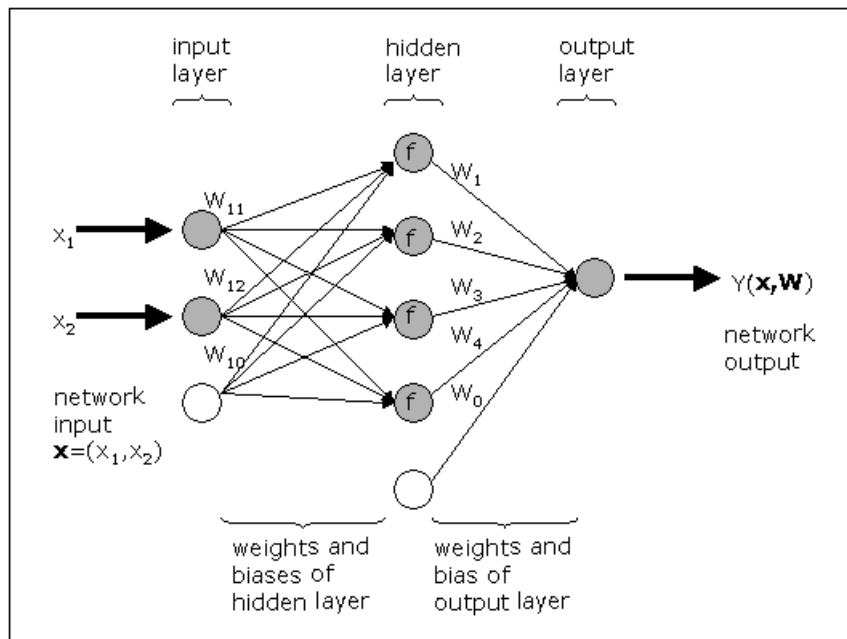


linearly) to the distance of points from its center. The RBF network output layer is typically linear. Intuitively, it is clear that a weighted sum of the sufficient radial units will always be enough to model any set of training data (see Figure 3-4 and Figure 3-5). The formal proofs of this property can be found, for example, in [9] and [10]. An RBF network can be trained extremely quickly, orders of magnitude faster than a feedforward network. The training process typically takes place in two distinct stages. First, the centers and deviations of the radial units (i.e. the hidden layer's weights) must be set; then the linear output layer is optimized. It is important that deviations are chosen so that RBFs overlap with some nearby units. Discovering a sub-optimal 'spread' parameter typically implies the preliminary experimental stage. If the RBFs are too spiky, the network will not interpolate between known points (see Figure 3-6). If the RBFs are very broad, the network loses fine detail (

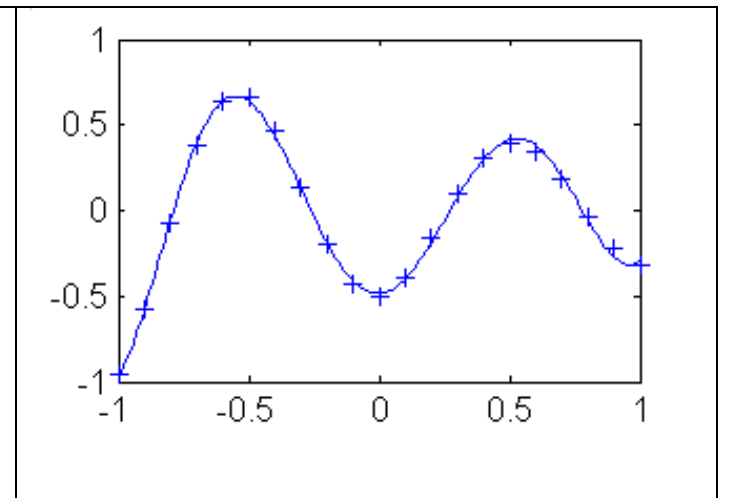
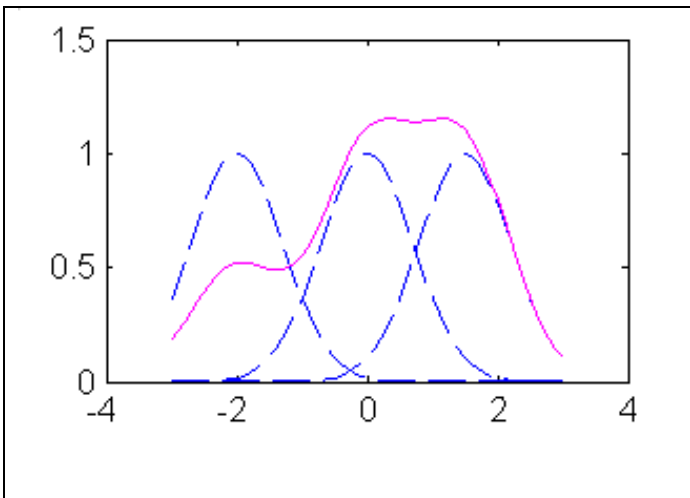
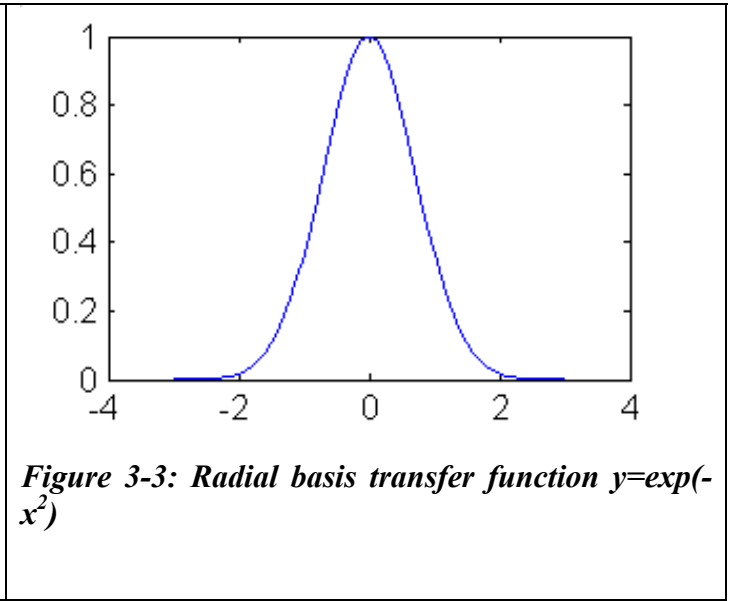
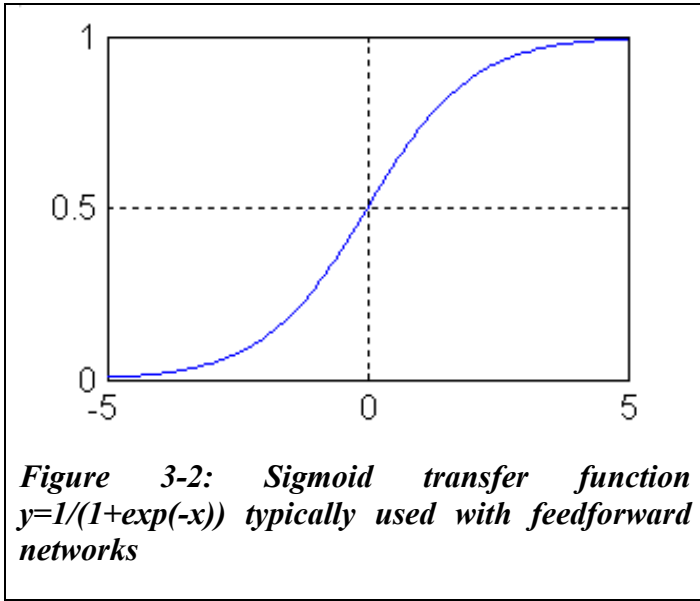
Figure 3-7). This is actually another manifestation of the over/under-fitting dilemma.

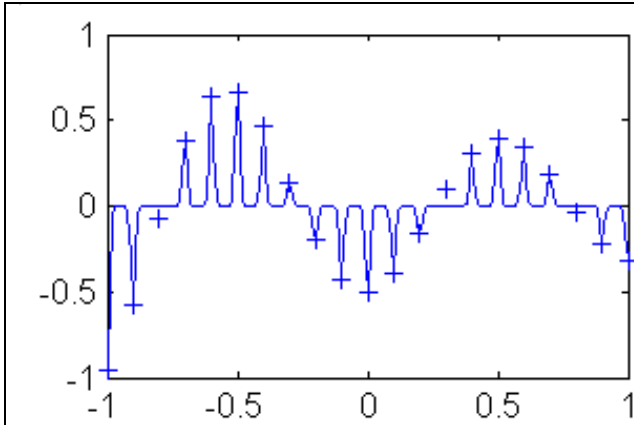
In the final shape, *after* training, a multilayer neural network with linear output (Figure 3-1) can resemble a general linear regression model - a least squares approximation. The major differences lie in the choice of basis functions and in the algorithms to construct the model (i.e. to adjust model's free parameters). Techniques to identify the systematical errors in the model and to estimate the uncertainty of model's prediction of future observations also become more complex. Unlike polynomial regressors, hidden neurons do not lend themselves to immediate interpretations in terms of input (design) variables.

The next sections discuss various goodness-of-fit assessment approaches applicable to neural networks. We also discuss how to estimate the variance of the neural model and how to compute derivatives of a neural network with respect to any of its inputs. Two neural network types, feedforward and radial basis, are considered.

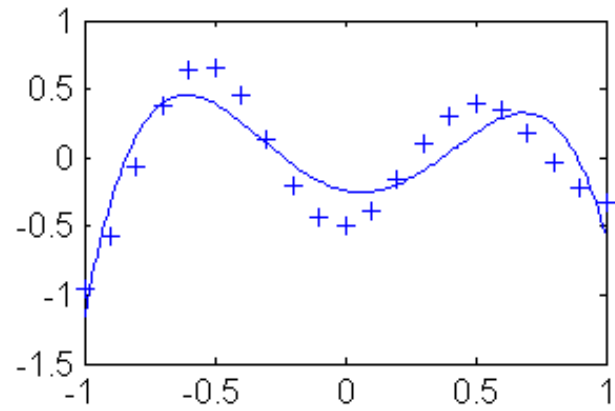


**Figure 3-1: Schematic of a neural network with 2 inputs and a hidden layer of 4 neurons with activation function  $f$ .**





**Figure 3-6:** The same 21 data points as in Figure 3-5. Test points reveal that the function has been overfit. RBF neuron's spread is too small. RBF network could have done better with a higher spread constant.



**Figure 3-7:** The same 21 data points as in Figure 3-5. Approximation with overlapping RBF neurons. The spread of RBF units is too high.

### 3.1.1. Model adequacy checking

Nature is rarely (if ever) perfectly predictable. Real data never exactly fit the model that is being used. One must take into consideration that the prediction errors not only come from the variance error due to the intrinsic noise and unreliabilities in the measurement of the dependent variables but also from the systematic (bias) error due to model mis-specification. According to George E.P. Box's famous maxim, "all models are wrong, some are useful". To be genuinely useful, a fitting procedure should provide the means to assess whether or not the model is appropriate and to test the goodness-of-fit against some statistical standard. There are several error measures available to determine the accuracy of the model. Among them are:

$$MSE = \sum_i^P (\hat{y}_i - y_i)^2 / P, \quad (3-1)$$

$$RMS = \sqrt{MSE}; \quad nMSE = MSE/\hat{\sigma}^2; \quad nRMS = RMS/\hat{\sigma}. \quad (3-2)$$

$$R^2 = \frac{\sum_i^P (\hat{y}_i - \bar{y})^2}{\sum_i^P (y_i - \bar{y})^2}, \quad \text{and} \quad R = \frac{\sum_i^P |\hat{y}_i - \bar{y}| |y_i - \bar{y}|}{\sum_i^P (y_i - \bar{y})^2 \sum_i^P (y_i - \bar{y})^2}, \quad (3-3)$$

where  $P$  denotes the number of data points,  $y_i$  is the observed response value ('target value'),  $\hat{y}_i$  is the model's prediction of response,  $\bar{y}$  is the mean (average) value of  $\hat{y}$ ,  $\bar{y}$  is the mean (average) value of  $y$ , and  $\hat{\sigma}^2$  is given by

$$\hat{\sigma}^2 = \frac{\varepsilon^2}{P-L} = \frac{\sum_{i=1}^P (y_i - \hat{y}_i)^2}{P-L}. \quad (3-4)$$

Mean squared error (MSE for short) and root mean squared error (RMS) summarize the overall model error. Unique or rare large error values can affect these indicators. Sometimes, MSE and RMS measures are normalized with sample variance of the target value (see formulae for nMSE and nRMS) to allow for comparisons between different datasets and underlying functions.  $R^2$  and  $R$  are relative measures. The coefficient of multiple determination  $R^2$  ('R-square') is the explained variance relative to the total variance in the target value. This indicator is widely used in linear regression analysis.  $R^2$  represents the amount of response variability explained by the model.  $R$  is the correlation coefficient between the network response and the target. It is a measure of how well the variation in the output is explained by the targets. If this number is equal to 1, then there is a perfect correlation between targets and outputs. Outliers can greatly affect the magnitudes of correlation coefficients. Of course, the larger the sample size, the smaller is the impact of one or two outliers.

Training accuracy measures (MSE, RMS,  $R^2$ ,  $R$ , etc.) are computed along all the data points used for training. As mentioned above, the performance of a good model on the training set does not necessarily mean good prediction of new (unseen) data. The objective measures of the prediction accuracy of the model are test errors computed along independent testing points (i.e. not training points). This is certainly true provided that we have an infinite number of testing points. In practice, however, test indicators are usable, only if treated with appropriate caution. Actual problems are often characterized by the limited availability of data, and when the training datasets are quite small and the test sets are even smaller, only quite large differences in performance can be reliably discerned by comparing training and test indicators.

The generalized cross-validation (GCV) [11] and Akaike's final prediction error (FPE) [12] provide computationally feasible means of estimating the appropriateness of the model. The  $k$ -fold cross-validation (denoted here as CV- $k$ ), generalized cross-validation (GCV) [11] and Akaike's final prediction error (FPE) [12] provide computationally feasible means of estimating the appropriateness of the model.

GCV and FPE estimates combine the training MSE with a measure of the model complexity:

$$MSE_{GCV} = MSE / (1 - \nu / P)^2, \quad (3-5)$$

$$RMS_{GCV} = \sqrt{MSE_{GCV}}, \quad nMSE_{GCV} = MSE_{GCV} / \hat{\sigma}^2; \quad nRMS_{GCV} = RMS_{GCV} / \hat{\sigma}. \quad (3-6)$$

$$MSE_{FPE} = MSE (1 + \nu / P) / (1 - \nu / P), \quad (3-7)$$

$$RMS_{FPE} = \sqrt{MSE_{FPE}}, \quad nMSE_{FPE} = MSE_{FPE} / \hat{\sigma}^2; \quad nRMS_{FPE} = RMS_{FPE} / \hat{\sigma}. \quad (3-8)$$

where  $\nu$  is the (effective) number of model parameters.

In theory, GCV estimates should be related to  $\nu$ . As a very rough approximation to  $\nu$ , we can assume that all of the network free parameters are well determined so that  $\nu = M$ , where  $M$  is the total number of network weights and biases. This is what we would expect to be the case for large  $P$  so that  $P \gg M$ . Note that GCV is undefined when  $\nu$  is equal to the number of training points ( $P$ ). In theory, GCV and FPE estimates should be related to the effective number of model's parameters  $\nu$ . Techniques to assess  $\nu$  for neural networks will be discussed later. As a very rough approximation, we can assume that all of the network free parameters are well determined so that  $\nu = M$ , where  $M$  is the total number of network weights and biases. This is what we would expect to be the case for large  $P$  so that  $P \gg M$ . Note that both GCV and FPE are undefined when the effective number of model's parameters ( $\nu$ ) is equal to the number of training points ( $P$ ). GCV and FPE measures are asymptotically equivalent for large  $P$ .

In  $k$ -fold cross-validation the training dataset is divided into  $k$  randomly selected disjoint subsets of roughly equal size  $P^{(j)}$ . The model is trained and tested  $k$  times. Each time  $j = 1, \dots, k$  it is trained on all data except for points from subset  $j$  and then tested on  $j$ -th subset. Formally, let  $y^{(j)} = (y_i^{(j)}), i = 1, \dots, P^{(j)}$  be the prediction of such a model for the points from subset  $j$ . Then the CV- $k$  estimates of accuracy

$$MSE_{CV-k} = \frac{\sum_{j=1}^k \sum_{i=1}^{P^{(j)}} (y_i^{(j)} - \hat{y}_i)^2}{P} \quad (3-9)$$

$$RMS_{CV-k} = \sqrt{MSE_{CV-k}}, nMSE_{CV-k} = MSE_{CV-k} / \hat{\sigma}^2; \quad nRMS_{CV-k} = RMS_{CV-k} / \hat{\sigma}. \quad (3-10)$$

The CV estimate is a random number that depends on the division into folds. Repeating cross-validation multiple times using different splits into folds provides a better approximation to complete  $N$ -fold cross-validation (leave-one-out). Leave-one-out measure is almost unbiased, but for typical real world datasets it has high variance, leading to unreliable estimates. Small datasets are simply not suitable for CV estimates, since data distribution can change considerably after we separate out even a small portion of data. In addition, the CV approach is usually too expensive. The question is whether the advantages of CV (if any) are big enough to justify the computational cost of training multiple networks rather than one.

Anyway, no accuracy estimation can be correct all the time. Most probably it is impossible to evaluate a model by means of a single descriptive measure. We should always consider several accuracy measures when deciding on the appropriateness of the model, especially if this model is trained on noisy and/or incomplete data. In certain cases the crucial phase of integrating disparate measures into a single judgment could be delegated to a statistical decision-making tool. Of course, when the quantity of data required for statistical methods is simply not available, human experts' knowledge should be used for the really big decisions.

### 3.1.2. Feedforward neural networks

Feedforward (FF) neural networks have a distinct layered topology. Each unit performs a biased weighted sum of their inputs and passes this value through a transfer (activation) function to produce the output. The outputs of each layer of neurons are the inputs to the next layer. In a feedforward network, the activation

function of intermediate ('hidden') layers is generally a sigmoidal function (Figure 3-3), network input and output layers being linear. Consider a FF network with  $K$  inputs, one hidden layer with  $H$  sigmoid units and a linear output unit. For a given input vector  $\mathbf{x} = (x_1, \dots, x_K)$  and network weights  $\mathbf{W} = (W_0, W_1, \dots, W_H, W_{10}, W_{11}, \dots, W_{HK})$ , the output of the network is:

$$\hat{y}(\mathbf{x}, \mathbf{W}) = W_0 + \sum_{h=1}^H W_h f\left(W_{h0} + \sum_{k=1}^K W_{hk} x_k\right), \quad (3-11)$$

where  $f(x) = 1/(1 + e^{-x})$ .

The computational graph of Eq. (3-11) is shown schematically in Figure 3-1. The extension to the case of more than one hidden layers can be obtained accordingly. It is straightforward to show that the derivative of the network Eq. (3-11) with respect to any of its inputs is given by:

$$\frac{\partial \hat{y}}{\partial x_k} = \sum_{h=1}^H W_h W_{hk} f'\left(W_0 + \sum_{h=1}^H W_h\right), k = 1, \dots, K. \quad (3-12)$$

Neural networks have been mathematically shown to be universal approximators of continuous functions and their derivatives (on compact sets) [4]. In other words, when a network (5) converges towards the underlying function, all the derivatives of the network converge towards the derivatives of this function.

Standard non-linear optimization techniques including a variety of gradient algorithms (the steepest descent, RPROP, Levenberg-Marquardt, etc.) are applied to adjust FF network's weights and biases. For neural networks, the gradients are easily obtained using a chain rule technique called 'backpropagation' [6]. The second-order Levenberg-Marquardt algorithm appears to be the fastest method for training moderate-sized FF neural networks (up to several hundred adjustable weights) [3]. However, when training larger networks, the first-order RPROP algorithm becomes preferable for computational reasons [13].

*Regularization:* For FF networks, regularization may be done by controlling the number of network weights ('model selection'), by imposing penalties on the weights ('ridge regression'), or by various combinations of these strategies ([7], [8]). Model selection requires choosing the number of hidden units and, sometimes, the number of network hidden layers. Most straightforward is to search for an 'optimal' network architecture that minimizes  $MSE_{GCV}$ ,  $MSE_{FPE}$  or  $MSE_{CV-k}$ . Often, it is feasible to loop over 1, 2, ... hidden units and finally select the network with the smallest GCV error. In any event, in order for the GCV measure to be applicable, the number of training points  $P$  should not be too small compared to the required network size  $M$ .

*Over-fitting:* To prevent over-fitting, it is always desirable to find neural solutions with the smallest number of parameters. In practice, however, networks with a very parsimonious number of weights are often hard to train. The addition of extra parameters (i.e. degrees of freedom) can aid convergence and decrease the chance of becoming stuck in local minima or on plateaus [14]. Weight decay regularization involves modifying the performance function  $F$ , which is normally chosen to be the mean sum of squares of the network errors on the training set (Eq. 3-1). When minimizing MSE (Eq. 3-1) the weight estimates tend to

be exaggerated. We can impose a penalty for this tendency by adding a term that consists of the sum of squares of the network weights (see also (Eq. 3-1)):

$$F = \beta E_D + \alpha E_W, \quad (3-13)$$

where

$$E_D = 0.5 \sum_{i=1}^P (\hat{y}_i - y_i)^2, \quad E_W = 0.5 \sum_{i=1}^M W_i^2,$$

where  $M$  is the number of weights and  $P$  the number of points in the training set.

Notice that network biases are usually excluded from the penalty term  $E_W$ . Using the modified performance function (Eq. 3-13) will cause the network to have smaller weights, and this will force the network response to be smoother and less likely to overfit. This eliminates the guesswork required in determining the optimum network size. Unfortunately, finding the optimal value for  $\alpha$  and  $\beta$  is not a trivial task. If we make  $\alpha/\beta$  too small, we may get over-fitting. If  $\alpha/\beta$  is too large, the network will not adequately fit the training data. A rule of thumb is that a little regularization usually helps [15]. It is important that weight decay regularization does not require that a validation subset be separated out of the training data. It uses all of the data. This advantage is especially noticeable in small sample size situations. Another nice property of weight decay regularization is that it can lend numerical robustness to the Levenberg-Marquardt algorithm. The L-M approximation to the Hessian of Eq. (3-13) is moved further away from singularity due to a positive addend to its diagonal:

$$\mathbf{A} = \mathbf{H} + \alpha \mathbf{I} \quad (3-14)$$

where

$$\mathbf{H} = \beta \nabla \nabla E_D \approx \sum_{i=1}^P \mathbf{g}(x^{(i)}) \mathbf{g}(x^{(i)})^T,$$

$$\mathbf{g}(\mathbf{x}) = \left( \frac{\partial \hat{y}}{\partial W_1}, \dots, \frac{\partial \hat{y}}{\partial W_M} \right)^T.$$

In [3], [16], [17] and [18] the Bayesian ('evidence framework' or 'type II maximum likelihood') approach to regularization is discussed. The Bayesian re-estimation algorithm is formulated as follows. At first, we choose the initial values for  $\alpha$  and  $\beta$ . Then, a neural network is trained using a standard non-linear optimization algorithm to minimize the error function (Eq. 3-13). After training, i.e. in the minimum of Eq. (3-13), the values for  $\alpha$  and  $\beta$  are re-estimated, and training restarts with the new performance function. Regularization hyper-parameters are computed in a sequence of 3 steps:

$$\nu = \frac{\sum_{m=1}^M \lambda_m}{\lambda_m + \alpha}, \quad (3-15)$$

where  $\lambda_m$ ,  $m = 1, \dots, M$  are (positive) eigenvalues of matrix  $\mathbf{H}$  in Eq. (3-14),  $\nu$  is the estimate of the effective number of parameters of a neural network,

$$\alpha = \nu/2E_W;$$

$$\beta = (P - \nu)/2E_D.$$

It should be noted that the algorithm (Eq. 3-15) relies on numerous simplifications and assumptions, which hold only approximately in typical real-world problems [19]. In the Bayesian formalism a trained network is described in terms of the posterior probability distribution of weight values. The method typically assumes a simple Gaussian prior distribution of weights governed by an inverse variance hyper-parameter  $\alpha = 1/\sigma_{weights}^2$ . If we present a new input vector to such a network, then the distribution of weights gives rise to a distribution of network outputs. There will be also an addend to the output distribution arising from the assumed  $\sigma_{noise}^2 = 1/\beta$  Gaussian noise on the output variables:

$$y = y(\mathbf{x}) + N(0, \sigma_{noise}^2)$$

With these assumptions, the negative log likelihood of network weights  $\mathbf{W}$  given  $P$  training points  $\mathbf{x}(1), \dots, \mathbf{x}(P)$  is proportional to MSE (Eq. 3-1), i.e., the maximum likelihood estimate for  $\mathbf{W}$  is that which minimizes (Eq. 3-1) or, equivalently,  $E_D$ . In order for Bayes estimates of  $\alpha$  and  $\beta$  to do a good job of minimizing the generalization in practice, it is usually necessary that the priors on which they are based are realistic. The Bayesian formalism also allows us to calculate error bars on the network outputs, instead of just providing a single 'best guess' output  $\hat{y}$ . Given an unbiased model, minimization of the performance function (Eq. 3-1) amounts to minimizing the variance of the model. The estimate for output variance  $\sigma_{\hat{y}|\mathbf{x}}^2$  of the network at a particular point  $\mathbf{x}$  is given by:

$$\sigma_{\hat{y}|\mathbf{x}}^2 \approx \mathbf{g}(\mathbf{x})^T \mathbf{A}^{-1} \mathbf{g}(\mathbf{x}). \quad (3-16)$$

Equation (3-16) is based on a second-order Taylor series expansion of Eq. (3-13) around its minimum and assumes that  $\partial \hat{y} / \partial \mathbf{W}$  is locally linear.

## Variability of Feedforward neural networks

Neural networks have a natural variability because of the following reasons [20]:

1. Local behavior of the neural network training algorithms
2. Uncertainty (noise) in the training data.



The neural network training error function usually has multiple local and global minima. With different initial weights, the training algorithm typically ends up in different (but usually almost equally good/bad) local minima. The larger the amount of noise in the data, the larger is the difference between these NN solutions. The user is allowed to specify a neural network committee to find the average net and quantify the variability (Section 13.1.3). The starting weights for network training are randomly generated using a user-specified seed to ensure repeatability (see Section 2.2.7).

### 3.1.3. Radial basis function networks

A radial basis function neural network has a distinct 3-layer topology. The input layer is linear (transparent). The hidden layer consists of non-linear radial units, each responding to only a local region of input space. The output layer performs a biased weighted sum of these units and creates an approximation of the input-output mapping over the entire space.

While several forms of radial basis function are considered in the literature, the most common functions are the Hardy's multi-quadrics and the Gaussian basis function. These are given as:

Hardy's multi-quadric:

$$g_h(x_1, \dots, x_K) = \sqrt{1 + (r^2 / \sigma_h^2)}. \quad (3-17)$$

Gaussian:

$$g_h(x_1, \dots, x_K) = \exp[-r^2 / 2\sigma_h^2] \quad (3-18)$$

The activation of  $h^{\text{th}}$  radial basis function is determined by the Euclidean distance  $r = \sqrt{\sum_{k=1}^K (x_k - W_{hk})^2}$  between the input vector  $\mathbf{x} = (x_1, \dots, x_K)$  and RBF center  $W_h = (W_{h1}, \dots, W_{hk})$  in  $K$ -dimensional space. The Gaussian basis function is a localized function (peaked at the center and descending outwards) with the property that  $g_h \rightarrow 0$  as  $r \rightarrow \infty$ . Parameter  $\sigma_h$  controls the smoothness properties of the RBF unit.

For a given input vector  $\mathbf{x}$  the output of RBF network with  $K$  inputs and a hidden layer with  $H$  basis function units is given by (see also Eqs. 3-17 and 3-18):

$$Y(\mathbf{x}, \mathbf{W}) = W_0 + \sum_{h=1}^H W_h f(\rho_h) \quad (3-19)$$

where

$$\rho_h = W_{h0} \sum_{k=1}^K (x_k - W_{hk})^2; \quad W_{h0} = 1/(2\sigma_h^2), \quad f(\rho) = \exp(-\rho).$$

Notice that hidden layer parameters  $W_h = (W_{h1}, \dots, W_{hk})$  represent the center of  $h^{\text{th}}$  radial unit, while  $W_{h0}$  corresponds to its deviation. Parameters  $W_0$  and  $W_1, \dots, W_H$  are the output layer's bias and weights, respectively.

A linear super-position of localized functions as in (13) is capable of universal approximation. The formal proofs of this property can be found, for example, in [9] and [10]. It is straightforward to show that the derivative of the network (13) with respect to any of its inputs is given by:

$$\frac{\partial Y}{\partial x_k} = \sum_{h=1}^H W_h W_{h0} \cdot 2(x_k - W_{hk}) \cdot f'(\rho_h), \quad k = 1, \dots, K, \quad (3-20)$$

where  $f'$  denotes the first derivative of the transfer function  $f : f'(\rho) = -\exp(-\rho)$ .

Theory tells us that when a network (Eq. 3-19) converges towards the underlying function, all the derivatives of the network converge towards the derivatives of this function.

A key aspect of RBF networks, as distinct from feedforward neural networks, is that they can be interpreted in a way which allows the hidden layer parameters (i.e. the parameters governing the radial functions) to be determined by semi-empirical, unsupervised training techniques. Accordingly, although a radial basis function network may require more hidden units than a comparable feedforward network, *RBF networks can be trained extremely quickly, orders of magnitude faster than FF networks.*

For RBF networks, the training process generally takes place in two distinct stages. First, the centers and deviations of the radial units (i.e. hidden layer parameters  $W_{11}, \dots, W_{HK}$  and  $W_{10}, \dots, W_{H0}$ ) must be set. All the basis functions are then kept fixed, while the linear output layer (i.e.,  $W_0, \dots, W_H$ ) is optimized in the second phase of training. In contrast, all of the parameters in a FF network are usually determined at the same time as part of a single training (optimization) strategy. Techniques for selecting  $W_{11}, \dots, W_{HK}$  and  $W_{10}, \dots, W_{H0}$  are discussed at length in following paragraphs. Here we shall assume that the RBF parameters have already been chosen, and we focus on the problem of optimizing the output layer weights.

Mathematically, the goal of output layer optimization is to minimize a performance function, which is normally chosen to be the mean sum of squares of the network errors on the training set (Eq. 3-1). If the hidden layer's parameters  $W_{10}, W_{11}, \dots, W_{HK}$  in (3.4-2) are kept fixed, then the performance function (Eq. 3-1) is a quadratic function of the output layer' parameters  $W_0, \dots, W_H$  and its minimum can be found in terms of the solution of a set of linear equations (e.g., using singular value decomposition). The possibility of avoiding the need for time-consuming and costly non-linear optimization during training is one of the major advantages of RBF networks over FF networks. However, when the number of optimized parameters ( $H + 1$ , in our case) is small enough, non-linear optimization (Levenberg-Marquardt, etc.) may also be cost-effective.

It is clear that the ultimate goal of RBF neural network training is to find a smooth mapping which captures the underlying systematic aspects of the data without fitting the noise. However, for noisy data, the exact RBF network, which passes exactly through every training data point, is typically a highly oscillatory function. There are a number of ways to address this problem. By analogy with FF network training, one can add to (Eq. 3-1) a regularization term that consists of the mean of the sum of squares of the optimized weights. In conventional curve fitting this form of regularization is called ridge regression. The sub-optimal value for hyperparameters  $\alpha$  and  $\beta$  in (3-13) can be found by applying Bayesian re-estimation formulae (Eq. 3-14) - (Eq. 3-15). It is also feasible to iterate over several trial values of  $\alpha$  and  $\beta$ .

For RBF networks, however, the most effective regularization methods are probably those pertaining to selecting radial centers and deviations in the first phase of RBF training. The commonly held view is that RBF centers and deviations should be chosen so as to form a representation of the probability density of the input data. The classical approach is to set RBF centers equal to all the input vectors from the training dataset. The width parameters  $\sigma_h$  are typically chosen – rather arbitrarily – to be some multiple  $S_\sigma$  of the average spacing between the RBF centers (e.g. to be roughly twice the average distance). This ensures that the RBF's overlap to some degree and hence give a relatively smooth representation of data.

To simplify matters, the same value of the width parameter  $\sigma_h$  for all RBF units is usually considered. Sometimes, instead of using just one value for all RBF's, each RBF unit's deviation  $\sigma_h$  is individually set to the distance to its  $N_\sigma \ll N$  nearest neighbors. Hence, deviations  $\sigma_h$  become smaller in densely populated areas of space, preserving fine detail, and are higher in sparse areas of space, interpolating between points where necessary. Again the choice of  $N_\sigma$  is somewhat arbitrary. RBF networks with individual radial deviations  $\sigma_h$  can be particularly useful in situations where data tend to cluster in only a small subregion of the design space (for example, around the optimum of the underlying system which RSM is searching for) and are sparse elsewhere.

One must take into consideration that after the first phase of RBF training is over, there's no way to compensate for large inaccuracies in radial deviations  $\sigma_h$  by, say, adding a regularization term to the performance function. If the basis functions are too spiky, the network will not interpolate between known points, and thus, will lose the ability to generalize. If the Gaussians are very broad, the network is likely to lose fine detail. The popular approach to find a sub-optimal spread parameter is to loop over several trial values of  $S_\sigma$  and  $N_\sigma$ , and finally select the RBF network with the smallest GCV (FPE, CV-k) error. This is somewhat analogous to searching for an optimal number of hidden units of a feedforward neural network.

In order to eliminate all the guesswork required in determining RBF deviations, it might seem natural to treat  $W_{10}, \dots, W_{H0}$  ( $\sigma_1, \dots, \sigma_H$ , to be precise) in (Eqs. 3-17 and 3-18) as adjustable parameters, which are optimized in the second phase of training along with the output layer's weights and bias. Practical applications of this approach, however, are rare. The reason may be that it requires the use of a non-linear optimization method in combination with a sophisticated regularization scheme specially designed so as to guarantee that the radial functions will remain localized.

It should be noted that RBF networks may have certain difficulties if the number of RBF units ( $H$ ) is large. This is often the case in multidimensional problems. The difficulty arises because for a large number of RBF's, a large number of training samples are required in order to ensure that the neural network parameters are properly determined. A large number of RBF units also increase the computation time spent on optimization of the network output layer and, consequently, the RBF architecture loses its main (if not the only one) advantage over FF networks – fast training.

Radial basis function networks actually suffer more from the curse of dimensionality than feedforward neural networks. To explain this statement, consider the effect of adding an extra, perfectly spurious input variable to a network. A feedforward network can learn to set the outgoing weights of the spurious input to zero, thus ignoring it. An RBF network has no such luxury: data in the relevant lower-dimensional space get 'smeared' out through the irrelevant dimension, requiring larger numbers of units to encompass the irrelevant variability.

In principle, the number of RBF's ( $H$ ) need not equal the number of training samples ( $P$ ), and RBF units are not constrained to be centered on the training data points. In fact, when data contain redundant information, we do not need all data points in learning. One simple procedure for selecting RBF centers is to set them equal to a random subset of the input vectors from the training set. Since they are randomly selected, they will 'represent' the distribution of the (redundant) training data in a statistical sense. Of course,  $H$  and  $P$  should not be too small in this case.

It is clear, however, that the optimal choice of RBF centers based on the input data alone need not be optimal for representing the input-output mapping as reflected in the observed data. In order to overcome these limitations, the selection procedure should take into account the output values, or at least, approximate estimates (assumptions) of the global behavior of the underlying system. The common neural term for such techniques involving output values is 'active learning'. In the context of active learning, RBF networks can be thought of as DOE metamodels analogous to polynomials, [16] and [19]. Given a candidate list of points, an active learner is searching for the 'best' points in order to position RBF centers. Popular in neural applications is to treat RBF active learning as 'pruning' technique intended for identifying critical data and discarding redundant points, or more accurately, not selecting some training points as RBF centers. RBF active learning methods are being successfully applied to approximate huge datasets that come from natural stochastic processes. It is questionable, however, whether active learning can be useful for non-redundant datasets, specifically for RSM design sets generated by performing DOE analysis based on low-order polynomial metamodels.

To briefly summarize, parameters governing radial units (radial centers and deviations) play a key role in generalization performance of a RBF model. The appropriate selection of RBF centers implies that we choose a minimal number of training data points that carry enough information to build an adequate input-output representation of the underlying function. Unfortunately, this is easier said than done. Indeed, there is a general agreement that selecting RBF centers and deviations is more Art than Science.

### 3.2. Kriging\*

Kriging is named after D. G. Krige [22], who applied empirical methods for determining true ore grade distributions from distributions based on sampled ore grades. In recent years, the Kriging method has found wider application as a spatial prediction method in engineering design. Detailed mathematical formulations of Kriging are given by Simpson [23] and Bakker [24].

The basic postulate of this formulation [23] is:

$$y(\mathbf{x}) = f(\mathbf{x}) + Z(\mathbf{x}), \quad (3-21)$$

where  $y$  is the unknown function of interest,  $f(\mathbf{x})$  is a known polynomial and  $Z(\mathbf{x})$  is the stochastic component with mean zero and covariance:

$$\text{Cov}[Z(\mathbf{x}^i), Z(\mathbf{x}^j)] = \sigma^2 \mathbf{R}([R(\mathbf{x}^i, \mathbf{x}^j)]). \quad (3-22)$$

With  $L$  the number of sampling points,  $\mathbf{R}$  is the  $L \times L$  correlation matrix with  $R(\mathbf{x}^i, \mathbf{x}^j)$  the correlation function between data points  $\mathbf{x}^i$  and  $\mathbf{x}^j$ .  $\mathbf{R}$  is symmetric positive definite with unit diagonal.

Two commonly applied correlation functions used are:

1. Exponential:  $R = \prod_{k=1}^n \exp(-\Theta_k |d_k|)$  and
2. Gaussian:  $R = \prod_{k=1}^n \exp(-\Theta_k d_k^2)$

where  $n$  is the number of variables and  $d_k = x_k^i - x_k^j$ , the distance between the  $k^{\text{th}}$  components of points  $\mathbf{x}^i$  and  $\mathbf{x}^j$ . There are  $n$  unknown  $\Theta$ -values to be determined. The default function in LS-OPT is Gaussian.

Once the correlation function has been selected, the predicted estimate of the response  $\hat{y}(\mathbf{x})$  is given by:

$$\hat{\mathbf{y}} = \hat{\beta} + \mathbf{r}^T(\mathbf{x})\mathbf{R}^{-1}(\mathbf{y} - \mathbf{f}\hat{\beta}) \quad (3-23)$$

where  $\mathbf{r}^T(\mathbf{x})$  is the correlation vector (length  $L$ ) between a prediction point  $\mathbf{x}$  and the  $L$  sampling points,  $\mathbf{y}$  represents the responses at the  $L$  points and  $\mathbf{f}$  is a  $L$ -vector of basis functions (ones, if  $f(\mathbf{x})$  is taken as a constant). One can choose either a constant, linear, or quadratic basis function in LS-OPT. The default choice is the constant basis function.

The vector  $\mathbf{r}$  and scalar  $\hat{\beta}$  are given by:

$$\mathbf{r}^T(\mathbf{x}) = [R(\mathbf{x}, \mathbf{x}^1), R(\mathbf{x}, \mathbf{x}^2), \dots, R(\mathbf{x}, \mathbf{x}^L)]^T$$

$$\hat{\beta} = (\mathbf{f}^T \mathbf{R}^{-1} \mathbf{f})^{-1} \mathbf{f}^T \mathbf{R}^{-1} \mathbf{y}.$$

The estimate of variance from the underlying global model is:

$$\hat{\sigma}^2 = \frac{1}{L} (\mathbf{y} - \mathbf{f}\hat{\boldsymbol{\beta}})^T \mathbf{R}^{-1} (\mathbf{y} - \mathbf{f}\hat{\boldsymbol{\beta}})$$

The maximum likelihood estimates for  $\Theta_k$ ,  $k = 1, \dots, n$  can be found by solving the following constrained maximization problem:

$$\max \Phi(\Theta) = -\frac{1}{2} [L \ln(\hat{\sigma}^2) + \ln|\mathbf{R}|], \text{ subject to } \Theta_k > 0 \wedge k.$$

where both  $\hat{\sigma}$  and  $|\mathbf{R}|$  are functions of  $\Theta$ . This is the same as minimizing

$$\hat{\sigma}^2 |\mathbf{R}|^{(1/n)}, \text{ subject to: } \Theta > 0.$$

This optimization problem is solved using the real-coded genetic algorithm (Section 4.8). A small constant number is adaptively added to the diagonal of matrix  $\mathbf{R}$  to avoid ill-conditioning. The net effect is that the approximating functions might not interpolate the observed response values exactly. However, these observations are still closely approximated.

### 3.3. Concluding remarks: which metamodel?

There is little doubt that the polynomial-based response surfaces are very robust, especially for sequential optimization methods. A negative aspect of using polynomials is the fact that the user is obliged to choose the order of polynomial. Also, a greater possibility exists for bias error of a nonlinear response. They are also, in most cases, not suitable for updating in sequential methods. Linear approximations may only be useful within a certain subregion and therefore quadratic polynomials or other higher order approximations such as RBF networks may be required for greater global accuracy. However the linear SRSM method has proved to be excellent for sequential optimization and can be used with confidence [25][26][27].

RBF Networks appear to be generally the best of the neural networks metamodels. They have the following advantages:

- Higher prediction accuracy due to built-in cross validation. Although FF networks may appear more accurate due to a smaller fitting error (RMSE), their prediction error is generally larger than that of RBF networks. An appealing plot of predicted vs. computed responses showing the training points or  $R^2$  values approaching unity or small RMS error values should not be construed as representing a higher accuracy.
- Higher speed due to their linear nature. When sizable FF committees (e.g. with 9 members) are used they may be vastly more expensive to construct than RBF networks. This is true especially for a relatively small number of variables.
- Relative independence of the calculation time with respect to the number of functions. Although there is a slight overhead which depends on this number, the user does not have to be as careful with limiting the number of responses.

FF Neural Networks function well as global approximations and no serious deficiencies have been observed when used as prescribed in Section 4.5. FF networks have been used for sequential optimization [27] and can be updated during the process. A more recent study [28] which focuses on the accuracy comparison for FF neural networks and RBF networks for different types of optimization strategies concluded that, for crashworthiness analysis, RBF and FF metamodels are mostly similar in terms of the accuracy of a large number of checkpoint results. However, the same study showed that Neural Networks are sometimes better than RBF networks for smooth problems. As mentioned earlier, RBF networks have a distinct speed advantage. Reference [28] also assesses the use of FF committees and concludes that, although expensive, there are some cases where they may be necessary.

Although the literature seems to indicate that Kriging is one of the more accurate methods [23], there is evidence of Kriging having fitting problems with certain types of experimental designs [29]. Kriging is very sensitive to noise, since it interpolates the data [30]. The authors of this manual have also experienced fitting problems with non-smooth surfaces ( $Z(x)$  observed to peak at data points) in some cases, apparently due to large values of  $\Theta$  that may be due to local optima of the maximum likelihood function. The model construction can be very time consuming [30] (also experienced with LS-OPT). Furthermore, the slight global altering of the Kriging surface due to local updating has also been observed [27]. Some efforts have been made in LS-OPT to reduce the effect of clustering of points.

Reference [27] compares the use of three of the metamodeling techniques for crashworthiness optimization. This paper, which incorporates three case studies in crashworthiness optimization, concludes that while RSM, NN and Kriging were similar in performance, RSM and NN were shown to be the most robust for this application. RBF networks were not available at the time of that study and Kriging has also been improved in the mean time.

### 3.4. REFERENCES

- [1] Daberkow, D.D., Mavris, D.N. An investigation of metamodeling techniques for complex systems design. *Symposium on Multidisciplinary Analysis and Design*, Atlanta, October 2002.
- [2] Redhe, M., Nilsson, L. Using space mapping and surrogate models to optimize vehicle crashworthiness design, *AIAA Paper 2002-5607. 9<sup>th</sup> AIAA/ISSMO Symposium on Multidisciplinary Analysis and Optimization*, Atlanta, September 4-6, 2003.
- [3] Bishop, C.M. *Neural Networks for Pattern Recognition*. Oxford University Press, 1995.
- [4] Hornik, K., Stinchcombe, M., White, H. Universal approximation of an unknown mapping and its derivatives using multilayer feedforward networks. *Neural Networks*, 3, pp. 535-549, 1990.
- [5] White, H., Hornik, K., Stinchcombe, M. Universal approximation of an unknown mapping and its derivatives. *Artificial Neural Networks: Approximations and Learning Theory*, H. White, ed., Oxford, UK: Blackwell, 1992.
- [6] Rummelhart, D.E., Hinton, G.E., Williams, R.J. Learning internal representations by error propagation. In D.E. Rumelhart and J.L. McClelland, editors, *Parallel Distributed Processing*, Vol. I Foundations, pages 318-362. MIT Press, Cambridge, MA, 1986.
- [7] Hoerl, A.H., Kennard, R.W., Ridge regression: Biased estimation for nonorthogonal problems. *Technometrics*, 12(3), pp. 55-67, 1970.

- [8] Tikhonov, A.N., Arsenin, V.Y., *Solutions of Ill-Posed Problems*, Winston: Washington, 1977.
- [9] Hartman, E.J., Keeler, J.D., Kowalski, J.M. Layered neural networks with Gaussian hidden units as universal approximations. *Neural Computation*, 2(2), pp. 210-215, 1990.
- [10] Park, J., Sandberg, I.W. Approximation and radial basis function networks. *Neural Computation*, 5(2), pp. 305-316, 1993.
- [11] Wahba, G. *Spline Models for Observational Data*. Volume 59 of Regional Conference Series in Applied Mathematics. SIAM Press, Philadelphia, 1990.
- [12] Akaike, H. Statistical predictor identification. *Ann.Inst.Statist.Math.*, 22, pp. 203-217, 1970.
- [13] Riedmiller, M., Braun, H. A direct adaptive method for faster backpropagation learning: The RPROP algorithm. In H. Ruspini, editor, *Proceedings of the IEEE International Conference on Neural Networks (ICNN)*, pp. 586 - 591, San Francisco, 1993.
- [14] Lawrence, S.C., Lee Giles, Ah Chung Tsoi. What size neural network gives optimal generalization? Convergence Properties of Backpropagation. *Technical Report UMIACS-TR-96-22 and CS-TR-3617*, University of Maryland, 1996.
- [15] Sjöberg, J., Ljung, L. Overtraining, regularization, and searching for minimum in neural networks. Preprints of the 4<sup>th</sup> IFAC Int. Symp. on Adaptive Systems in Control and Signal Processing, p. 669, July 1992.
- [16] MacKay, D. J. C. Bayesian interpolation. *Neural Computation*, 4(3), pp. 415-447, 1992.
- [17] Foresee, F. D., Hagan, M. T. Gauss-Newton approximation to Bayesian regularization. *Proceedings of the 1997 International Joint Conference on Neural Networks*, pp. 1930-1935, 1997.
- [18] Moody, J.E. The effective number of parameters: An analysis of generalization and regularization in nonlinear learning systems. in J.E. Moody, S.J. Hanson, and R.P. Lippmann, editors, *Advances in Neural Information Processing Systems*, 4, Morgan Kaufmann Publishers, San Mateo, CA, 1992.
- [19] Cohn, D. Neural network exploration using optimal experiment design, *Neural Networks*, (9)6, pp. 1071-1083, 1996.
- [20] Fedorova, N.N. Personal communication, 2004.
- [21] Shyy, W., Papila, N. Vaidyanathan, R. and Tucker, P.K. Global design optimization for aerodynamics and rocket propulsion components, *Progress in Aerospace Sciences*, 37, pp. 59-118, 2001.
- [22] Krige, D.G. *A Statistical Approach to Some Mine Valuation and Allied Problems on the Witwatersrand*. Masters thesis, University of the Witwatersrand, South Africa, 1951.
- [23] Simpson, T.W. *A Concept Exploration Method for Product Family Design*. Ph.D. Thesis, Georgia Institute of Technology, 1998.
- [24] Bakker, T.M.D. *Design Optimization with Kriging Models*. WBBM Report Series 47, Ph.D. thesis, Delft University Press, 2000.
- [25] Stander, N., Craig, K.J. On the robustness of a simple domain reduction scheme for simulation-based optimization, *Engineering Computations*, 19(4), pp. 431-450, 2002.
- [26] Stander, N., Reichert, R., Frank, T. 2000: Optimization of nonlinear dynamic problems using successive linear approximations. *AIAA Paper 2000-4798*.
- [27] Stander, N., Roux, W.J., Giger, M., Redhe, M., Fedorova, N. and Haarhoff, J. Crashworthiness optimization in LS-OPT: Case studies in metamodeling and random search techniques. *Proceedings of the 4<sup>th</sup> European LS-DYNA Conference*, Ulm, Germany, May 22-23, 2003. (Also [www.lstc.com](http://www.lstc.com)).
- [28] Stander, N. Goel, T. Metamodel sensitivity to sequential sampling strategies in crashworthiness design. *Proceedings of the 12<sup>th</sup> AIAA/ISSMO Multidisciplinary Analysis and Optimization Conference, Victoria, British Columbia, Canada, Sep 10-12, 2008. Submitted.*



- [29] Xu, Q-S., Liang, Y-Z., Fang, K-T., The effects of different experimental designs on parameter estimation in the kinetics of a reversible chemical reaction. *Chemometrics and Intelligent Laboratory Systems*, 52, pp. 155-166, 2000.
- [30] Jin, R., Chen, W. and Simpson, T.W. Comparative studies of metamodeling techniques under multiple modeling criteria, *AIAA Paper*, *AIAA-2000-4801*.
- [31] Simpson, T.W., Lin, D.K.J. and Chen, W. Sampling Strategies for Computer Experiments: Design and Analysis. *International Journal for Reliability and Applications*, Aug. 2001 (Revised Manuscript).
- [32] Jin, R., Chen, W. and Sudjianto, A. On sequential sampling for global metamodeling in engineering design, DETC-DAC34092, 2002 ASME Design Automation Conference, Montreal, Canada, September 2002.

# 4. Optimization

## 4.1. Theory of optimization

Optimization can be defined as a procedure for “achieving the best outcome of a given operation while satisfying certain restrictions” [1]. This objective has always been central to the design process, but is now assuming greater significance than ever because of the maturity of mathematical and computational tools available for design.

Mathematical and engineering optimization literature usually presents the above phrase in a standard form as

$$\begin{aligned} & \min f(\mathbf{x}) \\ & \text{subject to :} \\ & g_j(\mathbf{x}) \leq 0; j = 1, 2, \dots, m \\ & h_k(\mathbf{x}) = 0; k = 1, 2, \dots, l. \end{aligned} \tag{4-1}$$

where  $f$ ,  $g$  and  $h$  are functions of independent variables  $x_1, x_2, x_3, \dots, x_n$ . The function  $f$ , referred to as the cost or objective function, identifies the quantity to be minimized or maximized. The functions  $g$  and  $h$  are constraint functions representing the design restrictions. The variables collectively described by the vector  $\mathbf{x}$  are often referred to as design variables or design parameters.

The two sets of functions  $g_j$  and  $h_k$  define the constraints of the problem. The equality constraints do not appear in any further formulations presented here because algorithmically each equality constraint can be represented by two inequality constraints in which the upper and lower bounds are set to the same number, e.g.

$$h_k(\mathbf{x}) = 0 \approx 0 \leq h_k(\mathbf{x}) \leq 0 \tag{4-2}$$

Equations (2.1) then become

$$\begin{aligned} & \min f(\mathbf{x}) \\ & \text{subject to :} \\ & g_j(\mathbf{x}) \leq 0; j = 1, 2, \dots, m. \end{aligned} \tag{4-3}$$

The necessary conditions for the solution  $\mathbf{x}^*$  to Eq. (2.3) are the Karush-Kuhn-Tucker optimality conditions:

$$\begin{aligned}\nabla f(\mathbf{x}^*) + \boldsymbol{\lambda}^T \nabla g(\mathbf{x}^*) &= 0 \\ \boldsymbol{\lambda}^T \mathbf{g}(\mathbf{x}^*) &= 0 \\ \mathbf{g}(\mathbf{x}^*) &\leq 0 \\ \boldsymbol{\lambda} &\geq 0.\end{aligned}\tag{4-4}$$

These conditions are derived by differentiating the Lagrangian function of the constrained minimization problem

$$L(\mathbf{x}) = f(\mathbf{x}) + \boldsymbol{\lambda}^T \mathbf{g}(\mathbf{x}).\tag{4-5}$$

and applying the conditions

$$\nabla^T f \bar{\partial} \mathbf{x}^* \geq 0 \quad (\text{optimality})\tag{4-6}$$

and

$$\nabla^T \bar{\mathbf{g}} \bar{\partial} \mathbf{x}^* \leq 0 \quad (\text{feasibility})\tag{4-7}$$

to a perturbation  $\bar{\partial} \mathbf{x}^*$ .  $\lambda_j$  represents the Lagrange multiplier which may be nonzero only if the corresponding constraint is active, i.e.  $g_j(\mathbf{x}^*) = 0$ . For  $\mathbf{x}^*$  to be a local constrained minimum, the Hessian of the Lagrangian function,  $\nabla^2 f(\mathbf{x}^*) + \boldsymbol{\lambda}^T \nabla^2 \bar{\mathbf{g}}(\mathbf{x}^*)$  on the subspace tangent to the active constraint  $\bar{\mathbf{g}}$  must be positive definite at  $\mathbf{x}^*$ .

These conditions are not used explicitly in LS-OPT and are not tested at optima. They are more of theoretical interest in this manual, although the user should be aware that some optimization algorithms are based on these conditions.

## 4.2. Normalization of constraints and variables

It is a good idea to eliminate large variations in the magnitudes of design variables and constraints by normalization.

*Constraints.* In LS-OPT, a typical constraint is formulated as follows:

$$L_j \leq g_j(\mathbf{x}) \leq U_j; j = 1, 2, \dots, m.\tag{4-8}$$

This inequality represents two constraints:

$$L_j \leq g_j(\mathbf{x}); j = 1, 2, \dots, m. \quad (4-9)$$

$$g_j(\mathbf{x}) \leq U_j; j = 1, 2, \dots, m.$$

which, when normalized, become:

$$1 \leq \frac{g_j(\mathbf{x})}{L_j}; j = 1, 2, \dots, m. \quad (4-10)$$

$$\frac{g_j(\mathbf{x})}{U_j} \leq 1; j = 1, 2, \dots, m.$$

A feature is provided in the GUI to automatically switch on constraint scaling using a single check box. As

in Equation  $1 \leq \frac{g_j(\mathbf{x})}{L_j}; j = 1, 2, \dots, m.$  (4-10), the values of the

bounds,  $L_j$  and  $U_j$  are used as default scale factors, but can be selected.

*Variables.* The design variables have been normalized internally by scaling the design space  $[\mathbf{x}_L; \mathbf{x}_U]$  to  $[0; 1]$ , where  $\mathbf{x}_L$  is the lower and  $\mathbf{x}_U$  the upper bound. The formula

$$\xi_i = \frac{x_i - x_{iL}}{x_{iU} - x_{iL}}. \quad (4-11)$$

is used to transform each variable  $x_i$  to a normalized variable,  $\xi_i$ .

### 4.3. Gradient computation and the solution of optimization problems

Solving the optimization problem requires an optimization algorithm. The list of optimization methods is long and the various algorithms are not discussed in any detail here. For this purpose, the reader is referred to the texts on optimization, e.g. [1] or [2]. It should however be mentioned that the Sequential Quadratic Programming method is probably the most popular algorithm for constrained optimization and is considered to be a state-of-the-art approach for structural optimization [3], [4]. In LS-OPT, the subproblem is optimized by an accurate and robust gradient-based algorithm: the dynamic leap-frog method [5]. Both these algorithms and most others have in common that they are based on first order formulations, i.e. they require the first derivatives of the component functions

$$df/dx_i \text{ and } dg_j/dx_i$$

to construct the local approximations. These gradients can be computed either analytically or numerically. In order for gradient-based algorithms such as SQP to converge, the functions must be continuous with continuous first derivatives.

Analytical differentiation requires the formulation and implementation of derivatives with respect to the design variables in the simulation code. Because of the complexity of this task, analytical gradients (also known as design sensitivities) are mostly not readily available.

Numerical differentiation is typically based on forward difference methods that require the evaluation of  $n$  perturbed designs in addition to the current design. This is simple to implement but is expensive and hazardous because of the presence of round-off error. As a result, it is difficult to choose the size of the intervals of the design variables, without risking spurious derivatives (the interval is too small) or inaccuracy (the interval is too large). Some discussion on the topic is presented in Reference [1].

As a result, gradient-based methods are typically only used where the simulations provide smooth responses, such as linear structural analysis, certain types of nonlinear analysis or smooth metamodels (mathematical approximations) of the actual response.

In non-linear dynamic analysis such as the analysis of impact or metal-forming, the derivatives of the response functions are mostly severely discontinuous. This is mainly due to the presence of friction and contact. The response (and therefore the sensitivities) may also be highly nonlinear due to the chaotic nature of impact phenomena and therefore the gradients may not reveal much of the overall behavior. Furthermore, the accuracy of numerical sensitivity analysis may also be adversely affected by round-off error. Analytical sensitivity analysis for friction and contact problems is a subject of current research.

It is mainly for the above reasons that researchers have resorted to global approximation methods (also called metamodels) for smoothing the design response. The art and science of developing design approximations has been a popular theme in design optimization research for decades (for a review of the various approaches, see e.g. Reference [6] by Barthelemy). Barthelemy categorizes two main global approximation methods, namely response surface methodology [7] and neural networks [8]. Since then other approximations such as Radial Basis Function networks and Kriging have also become popular metamodels.

In the present implementation, the gradient vectors of general composites based on mathematical expressions of the basic response surfaces are computed using numerical differentiation. A default interval of 1/1000 of the size of the design space is used in the forward difference method.

## 4.4. Optimization methods

The two basic optimization branches employed in LS-OPT are Metamodel-based optimization and Direct optimization. Metamodel-based optimization is used to create and optimize an approximate model (metamodel) of the design instead of optimizing the design through direct simulation. The metamodel is thus created as a simple and inexpensive surrogate of the actual design. Once the metamodel is created, it can be used to find the optimum or, in the case of multiple objectives, the Pareto Optimal Front. Metamodeling techniques are discussed in Chapter 3.

The nature and capacity of the simulation environment as well as the purpose of the optimization effort typically dictate the strategies for metamodel-based optimization. The strategies depend mostly on whether the user wants to build a metamodel that can be used for global exploration or whether she is only interested in finding an optimal set of parameters. An important criterion for choosing a strategy is also whether the user wants to build the metamodel and solve the problem iteratively or whether he has a "simulation budget" i.e., a certain number of simulations that he wants to use as effectively as possible to build a metamodel and obtain as much information about the design as possible.

## **4.5. Strategies for metamodel-based optimization**

There are three recommended strategies for automating the metamodel-based optimization procedure. These strategies apply to the tasks: Metamodel-based Optimization and RBDO. The setup for each strategy is explained in detail in Section 20.3.

### **4.5.1. Single stage**

In this approach, the experimental design for choosing the sampling points is done only once. A typical application would be to choose a large number of points (as much as can be afforded) to build metamodels such as, RBF networks using the Space Filling sampling method. This is probably the best way of sampling for Space Filling since the Space Filling algorithm positions all the points in a single cycle.

### **4.5.2. Sequential strategy**

In this approach, sampling is done sequentially. A small number of points is chosen for each iteration and multiple iterations are requested. The approach has the advantage that the iterative process can be stopped as soon as the metamodels or optimum points have sufficient accuracy. It was demonstrated in Reference [16] that, for Space Filling, the Sequential approach had similar accuracy compared to the Single Stage approach, i.e.  $10 \times 30$  points added sequentially is almost as good as 300 points. Therefore both the Single Stage and Sequential Methods are good for design exploration using a surrogate model. For instance when constructing a Pareto Optimal Front, the use of a Single Stage or Sequential strategy is recommended in lieu of a Sequential strategy with domain reduction (see Section 4.5.3).

Both the previous strategies work better with metamodels other than polynomials because of the flexibility of metamodels such as neural networks to adjust to an arbitrary number of points.

### **4.5.3. Sequential strategy with domain reduction**

This approach is the same as that in 4.5.2 but in each iteration the domain reduction strategy is used to reduce the size of the subregion. During a particular iteration, the subregion is used to bind the positions of new points. This method is typically the only one suitable for polynomials. There are two approaches to Sequential Domain Reduction strategies. The first is global and the second, local.

## Sequential adaptive metamodeling (SAM)

As for the sequential strategy in Section 4.5.2 *without* domain reduction, sequential adaptive sampling is done and the metamodel constructed using all available points, including those belonging to previous iterations. The difference is that in this case, the size of the subregion is adjusted (usually reduced) for each iteration (see Section 4.6). This method is good for converging to an optimum and *moderately* good for constructing global approximations for design exploration such as a Pareto Optimal front. *The user should however expect to have poorer metamodel accuracy at design locations remote from the current optimum.*

## Sequential response surface method (SRSM)

SRSM is the original LS-OPT automation strategy of Section 4.6 and allows the building of a new response surface (typically linear polynomial) in each iteration. The size of the subregion is adjusted for each iteration (see Section 4.6). Points belonging to previous iterations are ignored. This method is only suitable for convergence to an optimum and should not be used to construct a Pareto optimal front or do any other type of design exploration. Therefore the method is ideal for system identification (see Section 5.3).

### 4.5.4. How do I choose an appropriate strategy for metamodel-based optimization?

Selecting the *Strategy* is the main selection for metamodel-based optimization. In the GUI, the three main choices, namely Single stage, Sequential or Sequential with Domain Reduction can be selected. If the Pareto Frontier option has been selected for a multi-objective optimization, Domain Reduction is automatically grayed out so is no longer an option. Hence few choices remain.

In the case of a single objective the user might want to change the design formulation or parameters such as constraint bounds *after* the run. In this case, Sequential (no Domain Reduction) should be used.

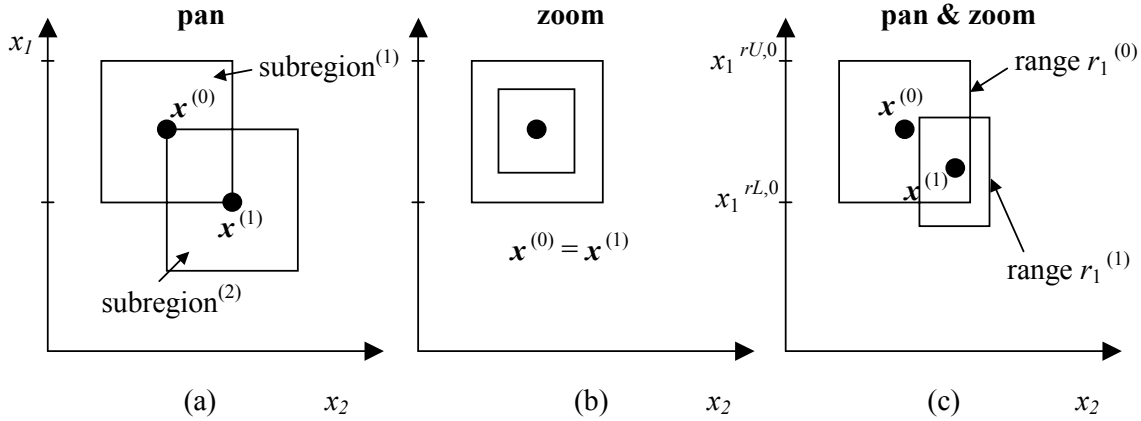
The Single Stage approach is intended for users who want to create a globally explorable model and have a fixed budget (e.g. 1000 runs). A very similar globally explorable design model can also be created with the Sequential strategy (without Domain Reduction) but an advantage of Sequential methods is that one can set stopping tolerances. These allow the accuracy of the design model to be maximized if sufficient computing resources are available.

Changing the strategy is flexible, so if, for instance, the user completes a Single Stage run and then decides that a refinement of the design model is needed, he can switch to Sequential and restart. Once the strategy is selected the remaining options are defaulted. For Sequential, the only remaining strategy settings are the convergence tolerances and limits.

## 4.6. Sequential response surface method (SRSM)

The purpose of the SRSM method is to allow convergence of the single-objective solution to a prescribed tolerance.

The SRSM method [15] uses a region of interest, a subspace of the design space, to determine an approximate optimum. A range is chosen for each variable to determine its initial size. A new region of interest centers on each successive optimum. Progress is made by moving the center of the region of interest as well as reducing its size. Figure 4-1 shows the possible adaptation of the subregion.



**Figure 4-1: Adaptation of subregion in SRSM: (a) pure panning, (b) pure zooming and (c) a combination of panning and zooming**

The starting point  $\mathbf{x}^{(0)}$  will form the center point of the first region of interest. The lower and upper bounds  $(x_i^{rL,0}, x_i^{rR,0})$  of the initial subregion are calculated using the specified initial range value  $r_i^{(0)}$  so that

$$x_i^{rL,0} = x_i^{(0)} - 0.5r_i^{(0)} \text{ and } x_i^{rU,0} = x_i^{(0)} + 0.5r_i^{(0)}; \quad i = 1, \dots, n \quad (4-12)$$

where  $n$  is the number of design variables. The modification of the ranges on the variables for the next iteration depends on the oscillatory nature of the solution and the accuracy of the current optimum.

*Oscillation:* A contraction parameter  $\gamma$  is firstly determined based on whether the current and previous designs  $\mathbf{x}^{(k)}$  and  $\mathbf{x}^{(k-1)}$  are on the opposite or the same side of the region of interest. Thus an *oscillation indicator*  $c$  may be determined in iteration  $k$  as

$$c_i^{(k)} = d_i^{(k)} d_i^{(k-1)} \quad (4-13)$$

where

$$d_i^{(k)} = 2\Delta x_i^{(k)} / r_i^{(k)}; \quad \Delta x_i^{(k)} = x_i^{(k)} - x_i^{(k-1)}; \quad d_i^{(k)} \in [-1; 1] \quad (4-14)$$

The oscillation indicator (purposely omitting indices  $i$  and  $k$ ) is normalized as  $\hat{c}$  where

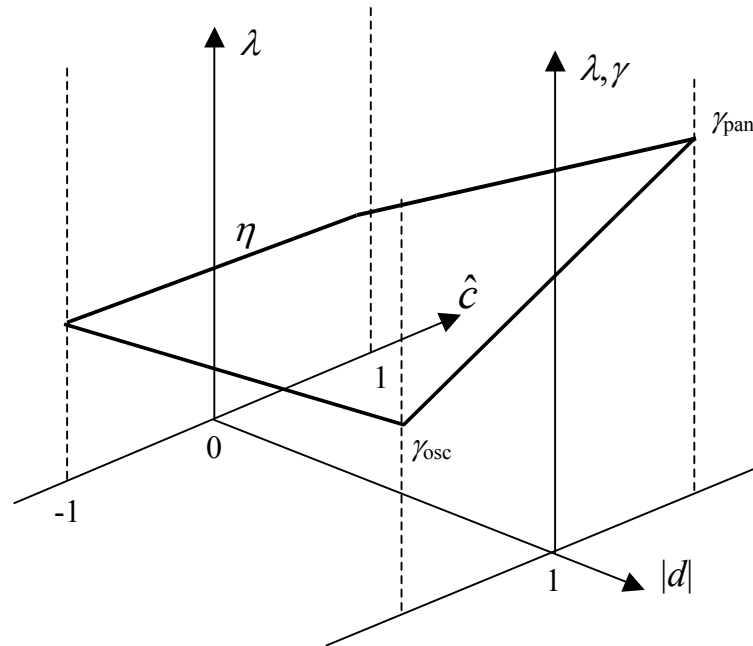
$$\hat{c} = \sqrt{|c|} \text{sign}(c) \quad (4-15)$$

The contraction parameter  $\gamma$  is then calculated as

$$\gamma = 0.5(\gamma_{pan} (1 + \hat{c}) + \gamma_{osc} (1 - \hat{c})) \quad (4-16)$$



See Figure 4-2. The parameter  $\gamma_{osc}$  is typically 0.5-0.7 representing shrinkage to dampen oscillation, whereas  $\gamma_{pan}$  represents the pure panning case and therefore unity is typically chosen.



**Figure 4-2: The sub-region contraction rate  $\lambda$  as a function of the oscillation indicator  $\hat{c}$  and the absolute move distance  $|d|$**

*Accuracy:* The accuracy is estimated using the proximity of the predicted optimum of the current iteration to the starting (previous) design. The smaller the distance between the starting and optimum designs, the more rapidly the region of interest will diminish in size. If the solution is on the bound of the region of interest, the optimal point is estimated to be beyond the region. Therefore a new subregion, which is centered on the current point, does not change its size. This is called *panning* (Figure 4-1(a)). If the optimum point coincides with the previous one, the subregion is stationary, but reduces its size (*zooming*) (Figure 4-1(b)). Both panning and zooming may occur if there is partial movement (Figure 4-1(c)). The range  $r_i^{(k+1)}$  for the new subregion in the  $(k + 1)$ -th iteration is then determined by:

$$r_i^{(k+1)} = \lambda_i r_i^{(k)}; i = 1, \dots, n; k = 0, \dots, niter \quad (4-17)$$

where  $\lambda_i$  represents the *contraction rate* for each design variable. To determine  $\lambda_i$ ,  $d_i^{(k)}$  is incorporated by scaling according to a *zoom parameter*  $\eta$  that represents pure zooming and the contraction parameter  $\gamma$  to yield the contraction rate

$$\lambda_i = \eta + |d_i^{(k)}|(\gamma - \eta) \quad (4-18)$$

for each variable (see Figure 4-2).

When used in conjunction with neural networks or Kriging, the same heuristics are applied as described above. However the nets are constructed using all the available points, including those belonging to previous iterations. Therefore the response surfaces are progressively updated in the region of the optimal point.

Refer to Section **20.4.1** for the setting of parameters in the iterative Sequential Response Surface Method.

## **4.7. Leapfrog optimizer for constrained minimization (LFOPC)**

The optimization algorithm used to solve the approximate subproblem is the LFOPC algorithm of Snyman [5]. It is a gradient method that generates a dynamic trajectory path, from any given starting point, towards a local optimum. This method differs conceptually from other gradient methods, such as SQP, in that no explicit line searches are performed.

The original leap-frog method [9] for unconstrained minimization problems seeks the minimum of a function of  $n$  variables by considering the associated dynamic problem of a particle of unit mass in an  $n$ -dimensional conservative force field, in which the potential energy of the particle at point  $\mathbf{x}(t)$  at time  $t$  is taken to be the function  $f(\mathbf{x})$  to be minimized.

The solution to the constrained problem may be approximated by applying the unconstrained minimization algorithm to a penalty function formulation of the original algorithm. The LFOPC algorithm uses a penalty function formulation to incorporate constraints into the optimization problem. This implies that when constraints are violated (active), the violation is magnified and added to an augmented objective function, which is solved by the gradient-based dynamic leap-frog method (LFOP). The algorithm uses three phases: Phase 0, Phase 1 and Phase 2. In Phase 0, the active constraints are introduced as mild penalties through the pre-multiplication of a moderate penalty parameter value. This allows for the solution of the penalty function formulation where the violation of the (active) constraints are pre-multiplied by the penalty value and added to the objective function in the minimization process. After the solution of Phase 0 through the leap-frog dynamic trajectory method, some violations of the constraints are inevitable because of the moderate penalty. In the subsequent Phase 1, the penalty parameter is increased to more strictly penalize violations of the remaining active constraints. Finally, and only if the number of active constraints exceed the number of design variables, a compromised solution is found to the optimization problem in Phase 2. Otherwise, the solution terminates having reached convergence in Phase 1. The penalty parameters have default values as listed in the User's manual (Section **20.9**). In addition, the step size of the algorithm and the termination criteria of the subproblem solver are listed.

The values of the responses are scaled with the values at the initial design. The variables are scaled internally by scaling the design space to  $[0; 1]$  interval. The default parameters in LFOPC (as listed in Section **20.9**) should therefore be adequate. The termination criteria are also listed in Section **20.9**.

In the case of an infeasible optimization problem, the solver will find the most feasible design within the given region of interest bounded by the simple upper and lower bounds. A global solution is attempted by multiple starts from the experimental design points.

## 4.8. Genetic algorithm

Genetic algorithms are nature inspired search algorithms that emulate the Darwinian principle of ‘survival of the fittest’. The concept of nature inspired algorithms was first envisaged by Prof. John Holland [10] at the University of Michigan in mid sixties. Later on this theory gained momentum in engineering optimization following the work of Prof. David Goldberg [11] and his students. The differences between genetic algorithms and most conventional optimization methods are:

- GA does not require derivative information to drive the search of optimal points.
- While conventional methods use a single point at each iteration, GA is a population based approach.
- GA is a global optimizer whereas conventional methods may get stuck in local optima.
- GA is a probabilistic optimization method that is, an inferior solution (that may help evolve the correct design variables structure) may also have a non-zero probability of participating in the search process.
- The computational cost of using GA may be high compared to derivative based methods.

### 4.8.1. Terminology

The Genetic Algorithm imitates nature so some of its terminology is derived from biology:

- **Individual** – Each design variable vector (often known as solution or design point) is called an individual.
- **Population** – A group of individuals is called a population. The number of individuals in a population is termed *population size*.
- **Chromosome** – The binary string used to encode design variables is called chromosome. Chromosomes are used with binary encoding or conventional GA only. There is no direct correspondence of chromosome in real coded GA. The length of a chromosome is the sum of number of bits assigned to each variable.
- **Gene** – In binary encoding, each bit is called a *gene*.
- **Fitness** – The fitness of an individual is analogous to objective function. Each individual is assigned a fitness value based on its objectives and constraints values. The selection process tries to maximize the fitness of a population. The individual with the highest fitness represents the optimal solution to a problem.
- **Generation** – A generation (iteration in general optimization lingo) comprises of application of genetic operators – selection, crossover, and mutation – to create a child population. At the end of each generation, the child population becomes the parent population.

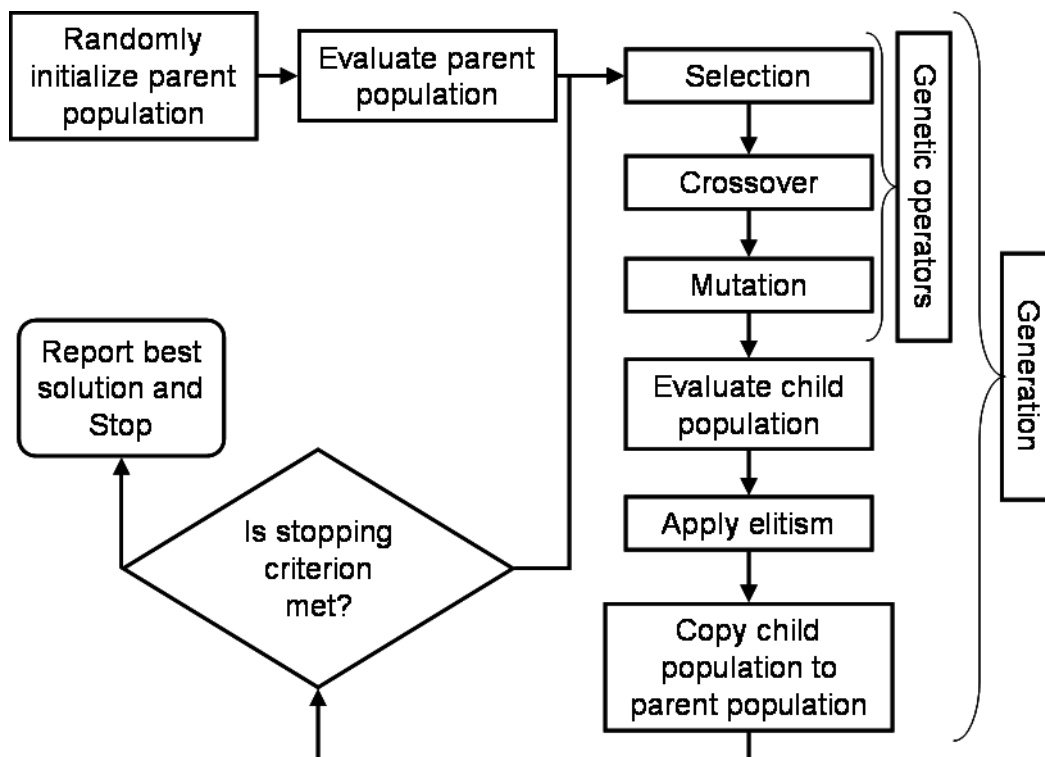
## 4.8.2. Encoding

To use the genetic algorithm for optimization, design variables of a mathematical optimization problem are encoded into a format required by GA. There are two prominent ways of encoding design variables:

- **Binary encoding** – The conventional approach of using genetic algorithm is to represent an optimization problem into a string of binary numbers (chromosomes). The number of bits assigned to each variable determines the solution accuracy. If  $p$  bits are used to represent a variable with lower and upper bounds  $x_l$  and  $x_u$ , respectively, the accuracy of this variable can be  $(x_u - x_l) / (2^p - 1)$ . While binary encoding is the most natural way to use genetic algorithms, it has two main problems: i) discretization of a continuous variable causes loss of accuracy in representation (depends on number of bits), ii) Hamming cliff problem – neighbors in real space may not be close in binary space such that it may be very difficult to find an optimal solution.
- **Real encoding** – To avoid the problems of using binary representation of real variables, researchers have suggested directly using real numbers. This required special methods to perform genetic operations like crossover and mutation.

## 4.8.3. Algorithm

The steps in a simple genetic algorithm are illustrated with the help of Figure 4-3.



**Figure 4-3: Simple genetic algorithm.**

Firstly, problem-specific GA parameters like population size  $N_{pop}$ , type of encoding, number of bits per variables for binary coding, number of generations are defined.

### ***Initialization***

Next, the population is randomly initialized i.e., binary chromosomes or real variable vectors for  $N_{pop}$  individuals are generated randomly.

### ***Function evaluation***

For binary encoding, each chromosome (binary string) is decoded to corresponding design variable vector. Next, objective functions, constraints, and constraint violation of each individual in parent population is evaluated and accordingly fitness of each individual is assigned.

### ***Selection or reproduction operator***

Selection operator is used to identify individuals with high fitness and to form a mating pool of size  $N_{pop}$ . This operator reduces diversity in the population by filtering out low fitness schema. Many reproduction operators are introduced in literature. Three selection operators implemented in LS-Opt are described below.

- **Tournament selection.** In tournament selection, ' $N_{tourn}$ ' ( $N_{tourn}$  is tournament size) individuals from a population, selected at random, participate in a tournament. The individual with the largest fitness is declared the winner. Mostly, practitioners use  $N_{tourn} = 2$ . Increasing the tournament size ' $N_{tourn}$ ' increases selection pressure and might lose diversity in the population that is required to drive the search.
- **Roulette wheel or proportionate reproduction.** In this selection approach, each individual is assigned a probability of selection based on its fitness value. In a population of  $N_{pop}$  individuals, the selection probability of the  $i^{th}$  individual is

$$P_i = F_i / \sum_{j=1}^{N_{pop}} F_j \quad (4-19)$$

where  $F_i$  is the fitness of  $i^{th}$  individual. High fitness individuals have a high probability of getting selected. This scheme is implemented by considering a roulette wheel with circumference marked by the fitness of each individual. One individual per spin of the wheel is selected. Then, the expected number of copies of the  $i^{th}$  individual in the mating pool can be estimated as

$$N_i = F_i / \bar{F}; \bar{F} = \frac{1}{N_{pop}} \sum_{j=1}^{N_{pop}} F_j. \quad (4-20)$$

This selection operator has a higher selection pressure compared to the tournament selection and can lead to a premature convergence to local optima.

- **Stochastic universal sampling.** The roulette wheel selection operator is often noisy because of multiple spins that correspond to round-off errors in computer simulations. To reduce this noise, it

was suggested to use a single spin of the wheel with  $N_{pop}$  equi-spaced pointers. This operator also has a high selection pressure.

### **Crossover**

Crossover is the main exploration operator of genetic search. In this operator,  $\mu$  randomly selected parents mate with a probability ( $P_c$ : crossover probability) to create  $\lambda$  children. These children share the attributes from all parents such that they may be better or worse individuals. There are two prominent strategies to create children: i)  $(\mu + \lambda)$  strategy selects best individuals from parents and children, and ii)  $(\mu, \lambda)$  strategy replaces parents with children irrespective of their fitness values. LS-OPT has adopted a (2, 2) strategy for crossover such that two parents create two children and children replace parents in the new generation. If parents do not create children, they are passed to the next generation.

There are many crossover operators in literature. A few popular crossover operators that have been shown to perform reasonably well are available in LS-OPT. A brief description of these operators is as follows:

- Single point binary crossover

This crossover operator is used for binary encoding of the individuals. Two parents and a mating site are randomly selected. All genes right to the mating sites are swapped between two parents.

- Uniform binary crossover

This crossover operator is also used for binary encoded individuals. For a randomly selected parent pair, genes are swapped based on a flip of a coin for each gene in the chromosome.

- Simulated binary real crossover (SBX)

This crossover operator, introduced by Deb and Agrawal in 1995 [12], is used with real encoding i.e., real variables are used as genes. This crossover emulates the single point binary crossover by assigning a probability distribution to each parent. Two children are created from two parents using that probability distribution such that the mean of parents and children are the same. The probability distribution is controlled by a distribution index  $\eta_c$  such that large value of  $\eta_c$  creates children near parents and small value of  $\eta_c$  creates children far from parents. Deb and Beyer [13] showed that SBX possesses self-adaptation capabilities.

- Blend real crossover (BLX- $\alpha$ )

This crossover operator was introduced by Eshelman and Schaffer in 1993 [14]. In this crossover, a child  $x$  is created from two parents  $x^{(1)}$  and  $x^{(2)}$  ( $x^{(2)} > x^{(1)}$ ) by randomly selecting a value from the interval  $[x^{(1)} - \alpha(x^{(2)} - x^{(1)}), x^{(2)} + \alpha(x^{(2)} - x^{(1)})]$ . Typically,  $\alpha$  is taken as 0.5.

### ***Mutation***

Mutation is carried out with a mutation probability ( $P_m$ ) to bring random changes in the individuals. This operator is very useful when population has lost diversity and the search has become stagnant. Then mutation can help improve diversity in the solutions. The mutation operators for binary and real encoding are given as follows:

- Simple binary mutation

In simple binary mutation of an individual, a bitwise mutation is carried out by changing a ‘0’ to ‘1’ or vice-versa with a small mutation probability  $P_m$ . Typically  $P_m$  is taken as the inverse of chromosome length such that on an average, one gene (bit) per chromosome is changed.

- Real mutation

As was used for the SBX operator, a distribution (defined by mutation distribution index) around each variable is specified and a random variable is selected from that distribution. Large values of the distribution index are recommended to create a child near the parent.

A complete cycle of selection, crossover, and mutation would result in a child population. The population size is kept constant for both parent and child populations.

### ***Elitism in simple genetic algorithm***

Due to the disruptive nature of exploration operators, high fitness individuals may get lost while creating a child population from the parent population. Sometimes, it is advantageous to keep these high fitness individuals to preserve favorable genetic information (schema). This process of artificially saving the best individuals is called elitism. To implement this process, the parent and child populations are ranked separately. The worst individuals in the child population are replaced by the best individuals from the parent population. The number of elites should be carefully chosen because a large number of elite solutions may drive the search to local optima by reducing the diversity in the population. On the other hand, too few elites may slow the convergence because favorable schema would spread at a slow rate.

After applying elitism, the child population is transferred to the parent population. The best individual found in the search process is preserved at each generation.

### ***Stopping criterion***

Many criteria have been specified in literature to terminate the GA search process. Some researchers have suggested stopping the search when there is no improvement in the last few generations. However, the most common stopping criterion is the fixed number of generations or function evaluations. A user-defined number of generations is used as the stopping criterion in LS-OPT.

At the end of simple genetic algorithm, the best individual (among all searched individuals) is reported as the optimal solution. If enough processing capabilities are carried out, the reported best individual would represent the global optimal solution.

## 4.9. Multi-objective optimization using genetic algorithms

Multi-objective optimization problems are significantly different than the single-objective optimization problems. MOO problems do not have a single optimal solution. Instead there is a set of solutions that reflects trade-offs among objectives. For MOO problems, population based methods like genetic algorithms are very attractive because many trade-off solutions can be found in a single simulation run. While it is easy to compare multiple designs for a single-objective optimization problem, special considerations are required to compare different designs. Goldberg [11] proposed a non-domination concept to compare different individuals. This idea forms the backbone of most MOGAs and is defined next.

### 4.9.1. Non-domination criterion

A non-domination criterion is used to identify better individuals without introducing any bias towards any objective ([17]-[19]). To understand the non-domination criterion, a domination criterion is defined as follows.

A solution  $\mathbf{x}^{(1)}$  dominates another solution  $\mathbf{x}^{(2)}$  ( $\mathbf{x}^{(1)} \succ \mathbf{x}^{(2)}$ ), if either of the following three conditions is true.

1.  $\mathbf{x}^{(1)}$  is feasible and  $\mathbf{x}^{(2)}$  is infeasible.
2. Both  $\mathbf{x}^{(1)}$  and  $\mathbf{x}^{(2)}$  are infeasible but  $\mathbf{x}^{(2)}$  is more infeasible compared to  $\mathbf{x}^{(1)}$ .
3. When both  $\mathbf{x}^{(1)}$  and  $\mathbf{x}^{(2)}$  are feasible,  $\mathbf{x}^{(1)}$  dominates  $\mathbf{x}^{(2)}$  ( $\mathbf{x}^{(1)} \succ \mathbf{x}^{(2)}$ ) if following two conditions are satisfied
  - $\mathbf{x}^{(1)}$  is no worse than  $\mathbf{x}^{(2)}$  in ‘all’ objectives, i.e.  $(f_j(\mathbf{x}^{(1)}) \not\geq f_j(\mathbf{x}^{(2)})) \quad j \in [1, 2, \dots, M]$ .
  - $\mathbf{x}^{(1)}$  is strictly better than  $\mathbf{x}^{(2)}$  in ‘at least one’ objective, i.e.,  $(f_j(\mathbf{x}^{(1)}) < f_j(\mathbf{x}^{(2)})), \wedge j \in [1, 2, \dots, M]$ .

If neither of the two solutions dominates the other, both solutions are non-dominated with respect to each other. An individual  $\mathbf{s}$  is considered non-dominated with respect to a set of solutions  $\mathcal{S}$ , if no solution in  $\mathcal{S}$  dominates  $\mathbf{s}$ .

### 4.9.2. Pareto optimal solutions

Any non-dominated solution in the entire design domain is a Pareto optimal solution. By definition, all Pareto optimal solutions are non-dominated solutions but vice-versa is not true.

Like single objective optimization problems, there are local and global Pareto optimal solutions. A non-dominated solution is a local Pareto optimal solution with respect to the considered non-dominated solution set, whereas a global Pareto optimal solution is non-dominated with respect to all solutions in the design domain.



### 4.9.3. Pareto optimal set

The set of all Pareto optimal solutions is the Pareto optimal set for the given problem.

### 4.9.4. Pareto optimal front

Function space representation of the Pareto optimal set is Pareto optimal front. When there are two conflicting objectives, the POF is a curve, when there are three objectives, POF is a surface, and for higher dimensions, POF is a hyper-surface.

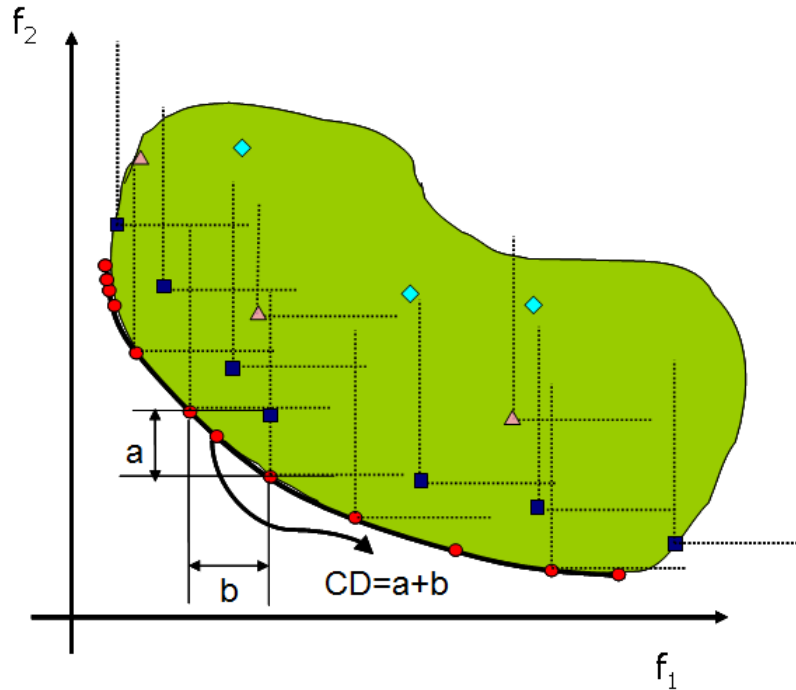
### 4.9.5. Ranking

Most MOGA search methods assign rank to different individuals based on non-domination criterion. This ranking is used to govern the search process. A rank of one is considered the best rank and low fitness individuals are assigned low ranks (large values of rank are low). Different individuals in a population are assigned rank as follows:

1. Initialize  $rnk = 1$ . Define a set of individuals  $S$ , same as the population.
2. Run a non-domination check on all individuals in  $S$ .
3. All non-dominated individuals are assigned rank =  $rnk$ .
4.  $rnk = rnk + 1$ .
5. Remove all non-dominated individuals from  $S$ .
6. If  $S \neq \Phi$ , repeat Step 2, else stop.

Note that many individuals can have the same rank.

Different concepts discussed here are illustrated using a two-objective unconstrained minimization problem in Figure 4-4. Each dot represents a solution in the design space that is shown as the shaded area. For each diamond, there is at least one triangle that is better than the diamond in at least one objective without being inferior in other objective. So all individuals represented by diamonds are dominated by the individuals represented by triangles. Similarly, all triangles are dominated by squares and squares are dominated by circular dots. No solution represented by triangles can be said better than any other solution represented by triangles. Thus, they are non-dominated with respect to each other. All individuals represented by circles are non-dominated with respect to any other individual hence they have a rank of one (best rank). If all points represented by circles are removed, the individuals represented by squares are non-dominated with respect to all remaining solutions such that they are assigned a rank of two, and so on. Note that all individuals with the same shape of dots have the same rank. For this example, all individuals with rank one (circular dots) also represent the true Pareto optimal solutions set. The line on the boundary shows the Pareto optimal front.



*Figure 4-4: Illustration of non-domination criterion, Pareto optimal set, and Pareto optimal front.*

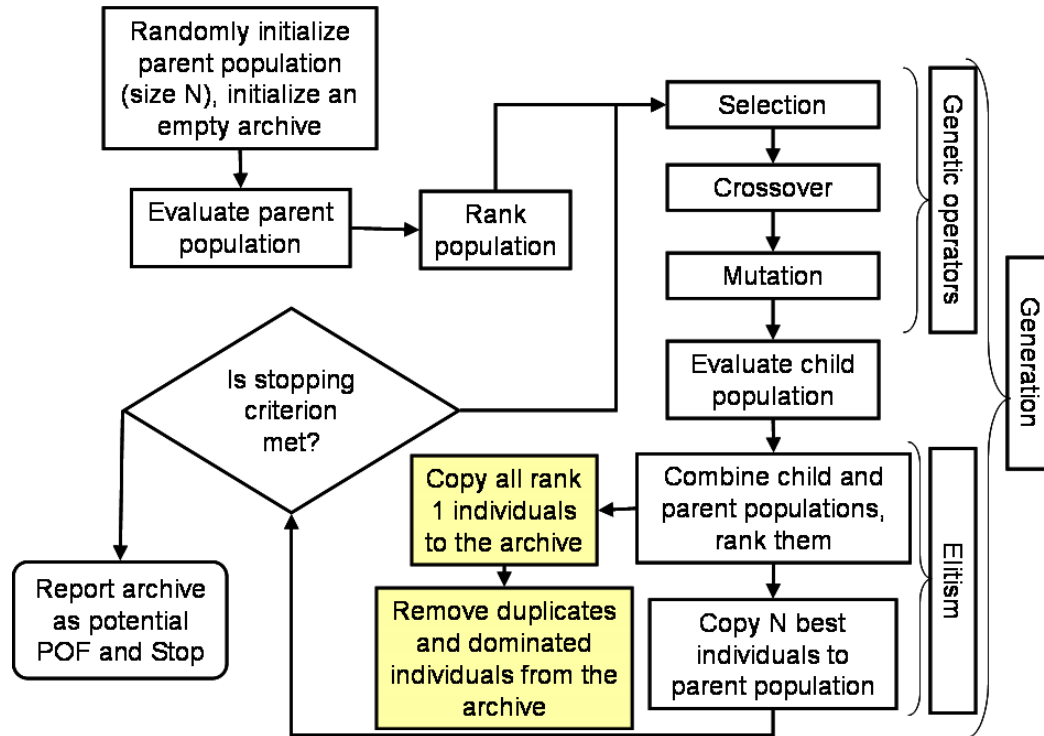
#### 4.9.6. Convergence vs. diversity

Different multi-objective optimization algorithms are compared using two criteria. First, convergence to the global Pareto optimal front, and second, diversity on the Pareto optimal front. The convergence criterion requires identifying the global Pareto optimal solution set.

A good multi-objective optimizer is required to maintain diversity (representation of different regions of the Pareto optimal front). This is an important criterion since our goal is to find different trade-off solutions. It is important to note that diversity on the Pareto optimal front (function space) does not mean the diversity in the variable space, i.e., small changes in variables can result in large changes in the function values.

#### 4.9.7. Elitist non-dominated sorting genetic algorithm (NSGA-II)

This algorithm was developed by Prof. Kalyanmoy Deb and his students in 2000 [20]. This algorithm first tries to converge to the Pareto optimal front and then it spreads solutions to get diversity on the Pareto optimal front. Since this algorithm uses a finite population size, there may be a problem of Pareto drift. To avoid that problem, Goel et al. [21] proposed maintaining an external archive.



**Figure 4-5: Elitist non-dominated sorting genetic algorithm (NSGA-II).** The shaded blocks are not the part of original NSGA-II but additions to avoid Pareto drift.

The implementation of this archived NSGA-II is shown in Figure 4-5, and described as follows:

1. Randomly initialize the parent population (size  $N_{pop}$ ). Initialize an empty archive.
2. Evaluate the population i.e., compute constraints and objectives for each individual.
3. Rank the population using non-domination criteria. Also compute the crowding distance (this distance finds the relative closeness of a solution to other solutions in the function space and is used to differentiate between the solutions on same rank).
4. Employ genetic operators – selection, crossover & mutation – to create a child population.
5. Evaluate the child population.
6. Combine the parent and child populations, rank them, and compute the crowding distance.
7. Apply elitism (defined in a following section): Select best  $N_{pop}$  individuals from the combined population. These individuals constitute the parent population in the next generation.
8. Add all rank = 1 solutions to the archive.
9. Update the archive by removing all dominated and duplicate solutions.
10. If the termination criterion is not met, go to step 4. Otherwise, report the candidate Pareto optimal set in the archive.

## 4.9.8. Elitism in NSGA-II

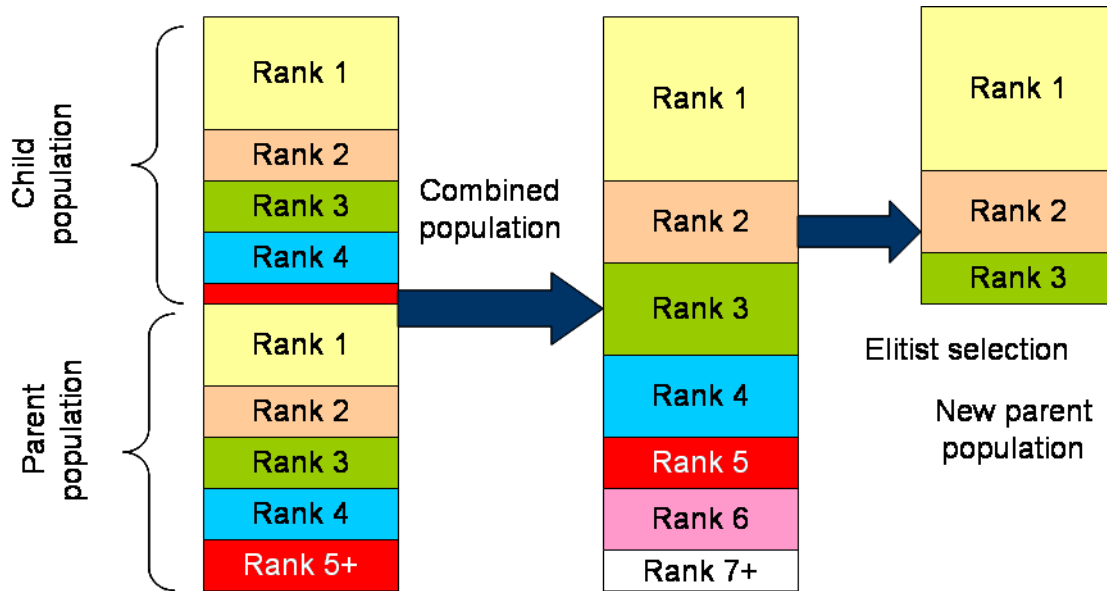


Figure 4-6: Elitism in NSGA-II.

Elitism is applied to preserve the best individuals. The mechanism used by NSGA-II algorithm for elitism is illustrated in Figure 4-6. After combining the child and parent populations, there are  $2N_{pop}$  individuals. This combined pool of members is ranked using non-domination criterion such that there are  $n_i$  individuals with rank  $i$ . The crowding distance of individuals with the same rank is computed. Steps in selecting  $N_{pop}$  individuals are as follows:

1. Set  $i = 1$ , and number of empty slots  $N_{slots} = N_{pop}$ .
2. If  $n_i < N_{slots}$ ,
  - Copy all individuals with rank ' $i$ ' to the new parent population.
  - Reduce the number of empty slots by  $n_i$ :  $N_{slots} = N_{slots} - n_i$ .
  - Increment ' $i$ ':  $i = i + 1$ .
  - Return to Step 2.
3. If  $n_i > N_{slots}$ ,
  - Sort the individuals with rank ' $i$ ' in decreasing order of crowding distance.
  - Select  $N_{slots}$  individuals.
  - Stop

### 4.9.9. Diversity preservation mechanism in NSGA-II – crowding distance calculation

To preserve diversity on the Pareto optimal front, NSGA-II uses a crowding distance operator. The individuals with same rank are sorted in ascending order of function values. The crowding distance is the sum of distances between immediate neighbors, such that in Figure 4-4, the crowding distance of selected individual is ‘ $a + b$ ’. The individuals with only one neighbor are assigned a very high crowding distance.

**Note:** It is important to scale all functions such that they are of the same order of magnitude otherwise the diversity preserving mechanism would not work properly.

### 4.10. Adaptive simulated annealing (ASA)

The Simulated Annealing (SA) is a global stochastic optimization algorithm that mimics the metallurgical annealing process. The original simulated annealing algorithm was developed as a generalization of the Metropolis Monte Carlo integration algorithm [22] to solve various combinatorial problems by Kirkpatrick et al. [23]. The term 'simulated annealing' derives from the rough analogy of the way that the liquefied metals at a high temperature crystallize on freezing. At high temperatures, the atoms in the liquid are at a high energy state and move freely. When the liquid is cooled, the energy of the molecules gradually reduces as they go through many lower energy states, and consequently their motion. If the liquid metal is cooled too quickly or 'quenched', the atoms do not get sufficient time to reach thermal equilibrium at a temperature and might result in a polycrystalline structure with higher energy. This atomic structure of material is not necessarily the most desired. However, if the rate of cooling is sufficiently slow, the atoms are often able to achieve the state of minimum (most stable) energy at each temperature state, resulting in a pure crystalline form. This process is termed as ‘annealing’. Kirkpatrick et al. [23] employed this annealing analogy to develop an efficient search algorithm. Pincus [24], and Cerny [25] also are also independently credited with the development of modern simulated annealing algorithm.

In simulated annealing parlance, the objective function of the optimization algorithm is often called ‘energy’  $E$  and is assumed to be related to the state, popularly known as temperature  $T$ , by a probability distribution. The Boltzmann distribution is the most commonly used probability distribution:

$$\text{Probability (E)} \sim \exp(-E / \kappa_B T),$$

where  $\kappa_B$  is the Boltzmann's constant.

#### 4.10.1. Algorithm

The search initializes with the temperature being high and cooling slowly such that the system goes through different energy states in search of the lowest energy state that is the global minima of the optimization problem. A stepwise description of the simulated annealing algorithm is as follows:

### Step 1: Initialization

The search starts by identifying the starting state  $\mathbf{x}^{(0)} \in \mathbf{X}$  and corresponding energy  $E^{(0)} = E(\mathbf{x})$ . The temperature  $T$  is initialized at a high value:  $T^{(0)} = T_{\max}$ . A cooling schedule, acceptance function, and stopping criterion are defined. This is iteration  $k = 0$ .  $\mathbf{X}^{(0)} = \{\mathbf{x}^{(0)}\}$ .

### Step 2: Sampling

A new point  $\mathbf{x}' \in \mathbf{X}$  is sampled using the candidate distribution  $D(\mathbf{X}^{(k)})$ , and set  $\mathbf{X}^{(k+1)} = \mathbf{X}^{(k)} \cup \{\mathbf{x}'\}$ , and corresponding energy is calculated  $E' = E(\mathbf{x}')$ .

### Step 3: Check acceptance

Sample a uniform random number  $\zeta$  in  $[0, 1]$  and set

$\mathbf{x}^{(k+1)} = \mathbf{x}'$  if  $\zeta \leq A(E', E^{(k)}, T^{(k)})$  or  
 $\mathbf{x}^{(k+1)} = \mathbf{x}^{(k)}$  otherwise.

where  $A(x)$  is the acceptance function that determines if the new state is accepted.

### Step 4: Temperature update

Apply the cooling schedule to the temperature:  $T^{(k+1)} = C(\mathbf{X}^{(k+1)}, T^{(k)})$ .

### Step 5: Convergence check

Stop the search if the stopping criterion is met, else set  $k = k+1$  and go to Step 2.

As is obvious, the efficiency of the simulated annealing algorithm depends on appropriate choices of the mechanism to generate new candidate states  $D$ , cooling schedule  $C$ , acceptance criterion  $A$ , and stopping criterion. While many options have been proposed in literature, the very fast simulated reannealing methodology proposed by Ingber (1989) [27] has been the most promising. This algorithm is also known as adaptive simulated annealing (ASA) [28]. The different selections along with a very brief historical perspective are outlined as follows.

#### 4.10.2. Acceptance function

Two most prominent *acceptance functions* used to accept a candidate point are the Metropolis criterion and the Barker criterion.

Metropolis criterion :  $A(E', E, T) = \min\{1, \exp(-(E' - E)/T)\}$ .

Barker criterion :  $A(E', E, T) = 1/\{1 + \exp((E' - E)/T)\}$ .

The theoretical motivation for such a restricted choice of acceptance functions can be found in [29]. It is also shown that under appropriate assumptions, many acceptance functions, which share some properties, are equivalent to the above two criteria. The Metropolis criterion is the most commonly used selection criterion and this is chosen as the acceptance function in LS-OPT.

### 4.10.3. Sampling algorithm

The choice of the next candidate distribution and the cooling schedule for the temperature are typically the most important (and strongly interrelated) issues in the definition of a SA algorithm. The *next candidate state*,  $\mathbf{x}'$ , is usually selected randomly among all the neighbors of the current solution,  $\mathbf{x}$ , with the same probability for all neighbors. The choice of the size of the neighborhood typically follows the idea that when the current function value is far from the global minimum, the algorithm should have more freedom, i.e., larger 'step sizes' are allowed. However, Ingber [27] suggested using a more complicated, non-uniformly selection procedure outlined below to allow much faster cooling rates.

Let  $i^{th}$  design variable be bounded as,  $x_i \in [A_i, B_i]$ . Then the new sample is given by

$$x'_i = x_i^{(k)} + v_i (B_i - A_i),$$

where  $v_i$  is estimated as follows.

$$v_i = \text{sgn}(u - 0.5) T_{p,i}^{(k)} \left[ (1 + 1/T_{p,i}^{(k)})^{|2u-1|} - 1 \right], u \in U[0,1].$$

The most important distinction in ASA with standard SA is the use of an independent temperature schedule ( $T_{p,i}$ ) for each parameter along with the temperature associated with the energy function. The cooling schedule for the parameter temperature, used to generate  $N$  dimensional design vector, is

$$T_{p,i}^{(k)} = T_{p,i}^{(0)} \exp(-c_i k^{1/N}).$$

$$c_i = m_i \exp(-n_i / N).$$

The control parameter  $c_i$  depends on two free parameters  $m_i$  and  $n_i$ , defined as

$$m_i = \log(T_{p,i}^{\min} / T_{p,i}^{(0)}), n_i = \log(N_{anneal}).$$

The ratio  $T_{p,i}^{\min} / T_{p,i}^{(0)}$  is the parameter temperature ratio and the parameter  $N_{anneal}$  is linked to the time allowed (number of steps) at each parameter temperature state. Ingber [30] found that the search procedure is sensitive to the choice of the two parameters and should be selected carefully. Relatively, the parameter temperature ratio is the more important of the two parameters.

#### 4.10.4. Cooling schedule

The basic idea of the *cooling schedule* is to start the algorithm off at high temperature and then gradually drop the temperature to zero. The primary goal is to quickly reach the so called effective temperature, roughly defined as the temperature at which low function values are preferred but it is still possible to explore different states of the optimized system, [31]. After that the simulated annealing algorithm lowers the temperature by slow stages until the system 'freezes' and no further changes occur. Geman and Geman [32] found the lower bound on the cooling schedule to be  $1/\log(t)$  where 't' is an artificial time measure of the annealing schedule. Hence,

$$T_i^{(k+1)} = T_i^{(0)} / \log(k).$$

This strategy is also known as Boltzmann annealing (Szu and Hartley) [33]. Later van Laarhoven and Aarts [34] modified this strategy to enable a much faster cooling schedule of

$$T_i^{(k+1)} = T_i^{(0)} / k.$$

A straightforward and most popular strategy is to decrement  $T$  by a constant factor every  $v_T$  iterations:

$$T := T / \mu_T$$

where  $\mu_T$  is slightly greater than 1 (e.g.  $\mu_T = 1.001$ ). The value of  $v_T$  should be large enough, so that 'thermal equilibrium' is achieved before reducing the temperature. A rule of thumb is to take  $v_T$  proportional to the size of neighborhood of the current solution.

Nevertheless, the fastest cooling rate was made possible by using Ingber's algorithm that allowed an exponentially faster cooling rate of

$$\begin{aligned} T_i^{(k)} &= T_i^{(0)} \exp(-ck^{1/N}) \\ c &= m \exp(-n/N). \end{aligned}$$

As was described in the previous section, the cooling rate is governed by the two free parameters that are linked to the temperature ratio and annealing scale,

$$m = \log(T^{\min} / T^{(0)}), \quad n = \log(N_{\text{anneal}}).$$

Typically the temperature ratio used to drive the energy (objective) function is linked to the parameter temperature ratio called here as 'cost-parameter annealing ratio'.

#### 4.10.5. Stopping criterion

Selection of an appropriate stopping criterion is one of the most difficult tasks in stochastic optimization algorithms because it is unknown *a priori* if the algorithm has reached the global optima or is stuck in a hard local optimum. Thus the stopping rules proposed in the literature about SA, all have a heuristic nature and are, in fact, more problem dependent than algorithm dependent. Some common ideas in the heuristics are i)



stop when it does not make a noticeable progress over a number of iterations, ii) stop when the number of function evaluations is reached, and iii) stop when the temperature has fallen substantially to a desired minimum level  $T_{min}$ . The last two criteria are used to terminate the adaptive simulated annealing search in LS-OPT.

#### 4.10.6. Re-annealing

For multi-dimensional problems, most often the objective function has variable sensitivities for different parameters and at different sampling states. Hence, it is worth while to adjust the cooling rates for different parameters. Ingber [27] used a reannealing algorithm to periodically update the annealing time associated with parameters and the energy function such that the search is more focused in the regions with potential of improvements. For this, he suggested computing the sensitivities of the energy function as,

$$s_i = \partial E / \partial x_i.$$

All the annealing time parameters  $k$  are updated by the largest sensitivity  $s_{max}$  as follows:

$$T_{p,i}^{(k)} = T_{p,i}^{(k)} (s_{max} / s_i),$$

$$k_i' = (\log(T_{p,i}^{(0)} / T_{p,i}^{(k)})) / N.$$

The new annealing time associated with the  $i^{th}$  parameter is  $k_i = k_i'$ . Similarly the temperature parameter associated with the energy function is scaled. One can easily deduce from the above formulation that reannealing stretches the ranges of the insensitive parameters relative to the sensitive parameters. More details of reannealing can be obtained elsewhere [30].

#### Some comments

1. It is difficult to find the initial temperature directly, because this value depends on the neighborhood structure, the scale of the objective function, the initial solution, etc. In [23] a suitable initial temperature is one that results in an average uphill move acceptance probability of about 0.8. This  $T^{(0)}$  can be estimated by conducting an initial search, in which all uphill moves are accepted and calculating the average objective increase observed. In some other papers, it is suggested that parameter  $T^{(0)}$  is set to a value, which is larger than the expected value of  $|E' - E|$  that is encountered from move to move. In [31] it is suggested to spend *most* of the computational time in short sample runs with different  $T^{(0)}$  in order to detect the effective temperature. In practice, the optimal control of  $T$  may require physical insight and trial-and-error experiments. According to [35], "choosing an annealing schedule for practical purposes is still something of a black art".
2. Simulated annealing has proved surprisingly effective for a wide variety of hard optimization problems in science and engineering. Many of the applications in our list of references attest to the power of the method. This is not to imply that a serious implementation of simulated annealing to a difficult real world problem will be easy. In the real-life conditions, the energy trajectory, i.e. the sequence of energies following each move accepted, and the energy landscape itself can be highly complex. Note that state space, which consists of wide areas with no energy change, and a few "deep, narrow valleys", or even worse, "golf-holes", is not suited for simulated annealing, because in a "long, narrow valley" almost all random steps are uphill. Choosing a proper stepping scheme is

crucial for SA in these situations. However, experience has shown that simulated annealing algorithms are more likely trapped in the *largest basin*, which is also often the basin of attraction of the global minimum or of the deep local minimum. Anyway, the possibility, which can always be employed with simulated annealing, is to adopt a multi-start strategy, i.e. to perform many different runs of the SA algorithm with different starting points.

3. Another potential drawback of using SA for hard optimization problems is that finding a good solution can often take an unacceptably long time. While SA algorithms may quickly detect the region of the global optimum, they often require a few iterations to improve its accuracy. For small and moderate optimization problems, one may be able to construct effective procedures that provide similar results much more quickly, especially in cases when most of the computing time is spent on calculations of values of the objective function. However, it should be noted that for large-scale multidimensional problems an algorithm which always (or often) obtains a solution near the global optimum is valuable, since various local deterministic optimization methods allow quick *refinement* of a nearly correct solution.

In summary, simulated annealing is a powerful method for global optimization in challenging real world problems. Certainly, some "trial and error" experimentation is required for an effective implementation of the algorithm. The energy (cost) function should employ some heuristic related to the problem at hand, clearly reflecting how 'good' or 'bad' a given solution is. Random perturbations of the system state and corresponding cost change calculations should be simple enough, so that the SA algorithm can perform its iterations efficiently. The scalar parameters of the simulated annealing algorithm have to be chosen carefully. If the parameters are chosen such that the optimization evolves too fast, the solution converges directly to some, possibly good, solution depending on the initial state of the problem.

## 4.11. Hybrid algorithms

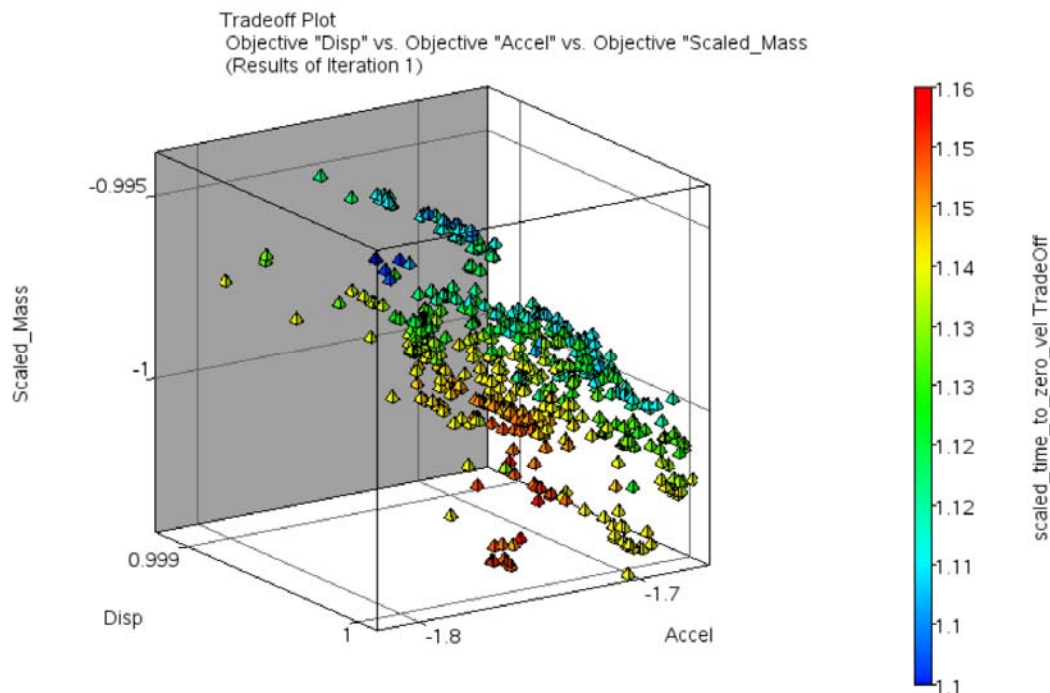
As discussed earlier, the stochastic algorithms like the genetic algorithm (GA) and adaptive simulated annealing (ASA) are designed to find the global optimal solution. However, one of the most difficult aspects of using stochastic algorithms is to identify the correct stopping criterion. A defensive, but likely expensive, approach is to run an algorithm sufficiently long to ensure the global optimal solution. However, the speed of finding the global optimum can be significantly increased by combining the global optimizers with local gradient based optimization methods. This combination, referred to as a *hybrid* algorithm, is based on a very simple idea that the global optimizers reach the basin of the global optimum quickly i.e., they find very high quality solutions, but significant effort is then required to achieve small improvements for refining the solution. On the other hand, gradient based optimization methods like LFOPC can find an optimal solution very quickly when starting from a good solution. Thus, in LS-OPT, a global optimizer such as the GA or ASA is used to find a good starting solution followed by a single LFOPC run to converge to the global optimum. This approach has been found to be both effective and efficient for global optimization. The hybrid algorithms are available for both the GA and ASA options.

## 4.12. Visualization of the Pareto optimal frontier

Due to the complexity of visualizing the Pareto Optimal Frontier (POF) for high dimensional problems, methods to improve exploration of the Pareto set have been devised. Several methods have been implemented in LS-OPT. These methods are described below:

### 4.12.1. Trade-off plot

This is the simplest of all plot types. The user creates a scatter plot of different entities, mostly objective functions, in a 3-D space. One can also add fourth entity in the form of the color. An example of the Trade-Off plot in four-dimensional space is shown in Figure 4-7. A serious limitation of this plot type is its inability to simultaneously show more than four dimensions.



*Figure 4-7: Trade-off plot shows all four objectives of Pareto optimal solutions.*

### 4.12.2. Hyper-radial visualization (HRV)

HRV [38] is based on the minimization of the sum of squares of the normalized objective functions which allows the POF to be displayed in two dimensions. HRV is effectively a 2-dimensional mapping of the  $n$ -dimensional objective function space.

The mathematical form of the multi-objective optimization problem is as follows:

$$\text{Minimize } F(x) = [f_1(x), f_2(x), \dots, f_n(x)] \text{ where } x = [x_1, x_2, \dots, x_p]$$

subject to

$g_j(x) \leq 0; \quad j = 1, 2, \dots, m$                       inequality constraints

$h_k(x) = 0; \quad k = 1, 2, \dots, l$                       equality constraints

$x_i^l \leq x_i \leq x_i^u; \quad i = 1, 2, \dots, p$                       side constraints

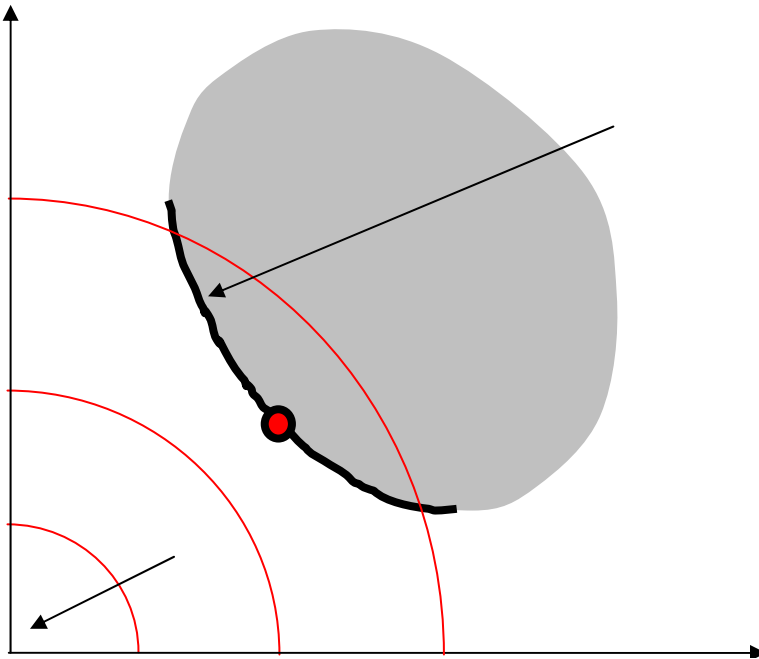
HRV can be seen as a conversion of the multi-objective optimization problem to a single objective optimization problem using the objective:

$$\frac{\sum_{i=1}^s W_i \tilde{F}_i^2 + \sum_{i=s+1}^n W_i \tilde{F}_i^2}{s}$$

subject to

$$\sum_{i=1}^n W_i = 1 \text{ and } W_i > 0$$

where  $s = n/2$  and the two additive components represent the objectives assigned to the two axes of the plot (see Figure 4-8). The case where  $n$  is an odd number is discussed below.



**Figure 4-8: The Pareto frontier and indifference curves**

The HRV method assumes that the set of Pareto points has already been computed and are available for display. First each objective function  $F_i$  is normalized to the range of the Pareto points. Normalization is done by using the lower and upper values of all the computed Pareto points to define the range for each objective.

$$\tilde{F}_i = \frac{F_i - F_{i \min}}{F_{i \max} - F_{i \min}} \quad i = 1, \dots, n \quad \text{where } \tilde{F}_i \in [0,1]$$

The coordinate  $[F_{1 \min}, F_{2 \min}, \dots, F_{n \min}]$  represents the *Utopian* point (see Figure 4-8), i.e. the point representing the minima of individual objectives. In the HRV representation, this point becomes the origin of the 2-dimensional plot. In addition to normalizing each objective function, the result of the Hyper-Radial Calculation (HRC) must also be normalized:

$$HRC = \sqrt{\frac{\sum_{i=1}^n \tilde{F}_i^2}{n}} \quad \text{where } HRC \in [0,1]$$

Now consider the  $n$ -objective sample data, corresponding to Pareto point  $j$  (of a total of  $q$  Pareto points). The objective functions are grouped into 2 sets controlled by the designer and an HRC value is computed for each group resulting in the coordinates HRC1 and HRC2. Thus  $s$  objectives are represented by HRC1 while  $n-s$  objectives are represented by HRC2. The two groups are therefore

$$\text{Group 1:} \quad [F_1, F_2, F_3, \dots, F_s] \quad HRC1 = \sqrt{\frac{\sum_{i=1}^s \tilde{F}_i^2}{s}}$$

$$\text{Group 2:} \quad [F_{s+1}, F_{s+2}, F_{s+3}, \dots, F_n] \quad HRC2 = \sqrt{\frac{\sum_{i=s+1}^n \tilde{F}_i^2}{n-s}}$$

The formulation is unbiased because the objectives can be grouped in an arbitrary way without sacrificing the unbiased visualization property. This means the radius originating in the Utopian point of any point is preserved irrespective of the objective grouping. The 'best' design is therefore considered to be the one closest to the Utopian point, i.e., the one with the smallest radius in the 2-dimensional plot.

The distance from the Utopian point is not the only criterion of how good a design is since a designer may also have a preference regarding the objectives. Preferences are incorporated by adding weights to the objectives represented in the HRC functions:

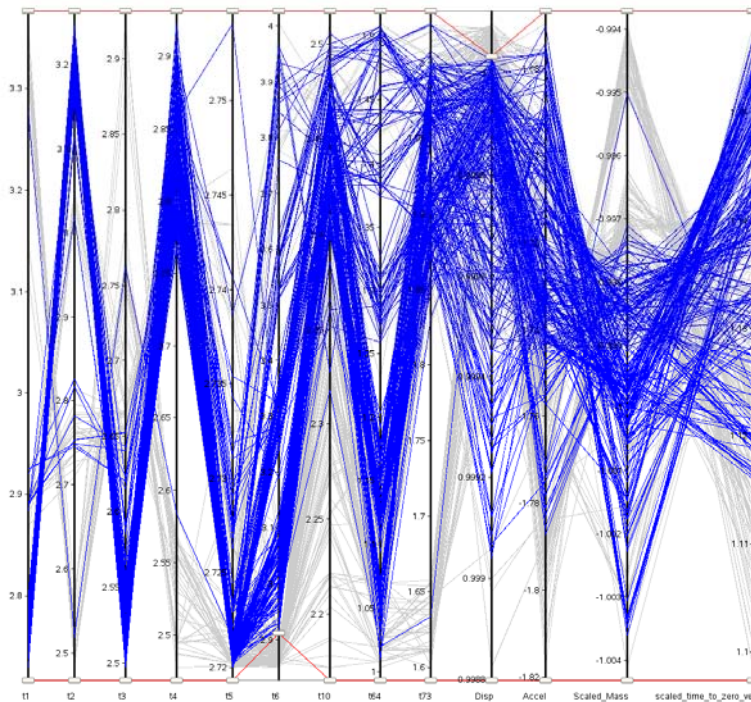
$$\text{Group 1:} \quad [F_1, F_2, F_3, \dots, F_s] \quad HRCW1 = \sqrt{\frac{\sum_{i=1}^s W_i \tilde{F}_i^2}{s}}$$

Group 2:  $[F_{s+1}, F_{s+2}, F_{s+3}, \dots, F_n]$   $HRCW2 = \sqrt{\frac{\sum_{i=s+1}^n W_i \tilde{F}_i^2}{s}}$

When  $(n-s < s)$  as is the case when, for instance,  $n$  is an odd number,  $(2s-n)$  dummy objective functions are added to normalize the visualization. This is to avoid producing an elliptical set of indifference curves. A dummy objective is a  $q$ -dimensional null vector,  $q$  being the number of Pareto points. The addition of such a dummy objective ensures the preservation of the indifference radius, so if the groupings are reselected, a particular Pareto point will move tangent to its current radius and therefore maintain its level of indifference.

### 4.12.3. Parallel co-ordinate plot (PCP)

The parallel coordinate plot shows all entities of a design by a line such that any number of entities can be simultaneously shown. An example of PCP is shown in Figure 4-9. The user can move the sliders on each entity to filter-out the undesired values and screen the objectives. The screened out solutions are shown as the grey-lines in Figure 4-9.



*Figure 4-9: Parallel coordinate plot shows objectives and design variables of all points on the Pareto front.*

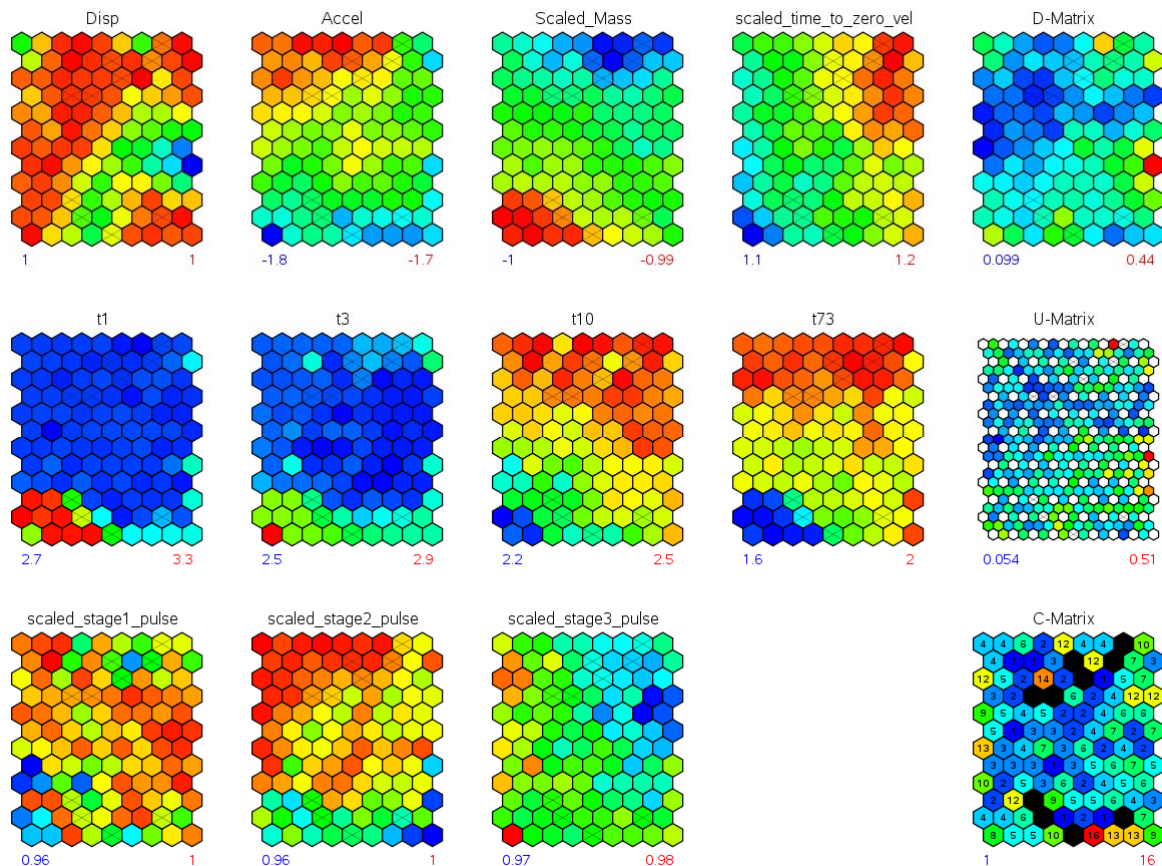
### 4.12.4. Self organizing maps (SOM)

Self organizing map [39], proposed by Kohonen in early 1980s, is a very powerful technique to represent  $n$ -dimensional data in two-dimensional space. The designs that are close in the  $n$ -dimensional space remain close to each other in the mapped space as well. These maps allow the user to explore the solution space in

many dimensions simultaneously. Figure 4-10 shows an example of a self organizing map. One can simultaneously see design objectives, variables, and constraints.

By default, the network is trained with 12 rows and 9 columns i.e., 108 nodes but the number of units can be controlled in the viewer GUI. With a trained SOM, one can show the following:

1. **Component maps:** Each component map shows one entity e.g., variables, responses, etc. One can simultaneously plot different component maps to see the variation in data in different regions.
2. **D-matrix:** This map shows the average distance from the neighboring units in the maps. This feature helps identify sparse sections in the data.
3. **U-matrix:** The U-matrix map shows the actual distances between the two neighboring units.
4. **C-matrix:** This plot illustrates the density associated with each SOM unit. For a well trained network, the C-matrix plot would also identify sparsely distributed data.



*Figure 4-10: Self organizing maps display design objectives, variables, and constraints on the Pareto front.*

### 4.13. Performance metrics for multi-objective optimization

Since multi-objective optimization results in a set of solutions, it requires special metrics to assess the convergence to the Pareto optimal front, diversity on the front, and the spread of the front. While the users



can get detailed information on performance metrics for multiobjective optimization problems elsewhere [17], a few metrics available in LSOPT are described here.

#### 4.13.1. Number of nondominated points

This is the number of solutions in the archive of all nondominated solutions at any generation. Usually a higher number of nondominated points are achieved when convergence is good.

#### 4.13.2. Spread

The spread of the front is calculated as the diagonal of the largest hypercube in the function space that encompassed all points. A large spread is desired to find diverse trade-off solutions. The spread measure is derived using the extreme solutions making it susceptible to the presence of a few isolated points that could artificially improve the spread metric. An equivalent criterion might be the volume of such a hypercube.

#### 4.13.3. Standard deviation of crowding distance

This complimentary criterion (to the spread metric) detects the presence of poorly distributed solutions by estimating how uniformly the points are distributed in the Pareto optimal set. This metric is defined as,

$$\delta = \sum_{i=1}^N \frac{|d_i - \bar{d}|}{N}; \bar{d} = \frac{1}{N} \sum_{i=1}^N d_i.$$

where  $d_i$  is the crowding distance of the solution in the function or variable space. The boundary points are assigned a crowding distance of twice the distance to the nearest neighbor. A small value of the uniformity measure is desired to achieve a good distribution of points.

#### 4.13.4. Min/Max of objectives

This represents the range of individual objectives. A wide range represents more choices for the designer.

#### 4.13.5. Hypervolume

A dominated hypervolume metric tries to simultaneously estimate the convergence and spread characteristics by computing the union of the volume between the optimal solutions and a reference point. For practical purposes, the nadir point of all solutions is used as the reference point.

While all the above metrics are obtained on a single set of solutions, the following performance metrics are obtained by comparing multiple sets of solutions. These metrics are helpful in determining the convergence. In LSOPT, the set of non-dominated solutions separated by  $\Delta$  generations (archive  $A_i$  and  $A_{i-\Delta}$ ) are compared and the following metrics are reported.  $\Delta$  is called generation interval.

#### 4.13.6. Number of common points

This is the number of solutions that exist in both sets  $A_i$  and  $A_{i-\Delta}$ . A large number of common points is indicative of the high quality of solutions. The set of common solutions is represented as,



$$Q = \{a_i : a_{i-\Delta} = a_i\}, a_{i-\Delta} \in A_{i-\Delta}, a_i \in A_i.$$

and  $n(Q)$  is the size of set  $Q$ . This is a particularly good metrics when a large generation interval is used.

#### 4.13.7. Number of new nondominated solutions

This metrics denotes the number of nondominated solutions that were evolved during the current generation interval. The set of such solutions is represented as,

$$Q = \{a_i : a_{i-\Delta} \neq a_i\}, a_{i-\Delta} \in A_{i-\Delta}, a_i \in A_i.$$

A large number of new solutions relative to the total archive size indicates that the new solutions are still being evolved and hence convergence is not yet achieved.

#### 4.13.8. Number of old dominated solutions $n(Q)$

This metrics denotes the number of nondominated solutions in the older archive  $A_{i-\Delta}$  that were dominated by the solutions in the current archive  $A_i$ . The set of dominated solutions is,

$$Q = \{a_{i-\Delta} : a_{i-\Delta} \prec a_i\}, a_{i-\Delta} \in A_{i-\Delta}, a_i \in A_i.$$

A large number of dominated solutions represents significant evolution.

#### 4.13.9. Consolidation ratio

This represents the fraction of archive  $A_i$  that has evolved up to the  $i-\Delta^{\text{th}}$  generation. This is computed as the ratio of the number of members in archive  $A_{i-\Delta}$  that are also present in the archive  $A_i$  (non-dominated solutions) to the size of archive  $A_i$ . Mathematically,

$$CR = \frac{n(S)}{n(A_i)}; S = \{a_{i-\Delta} : a_{i-\Delta} \neq a_i\}, a_{i-\Delta} \in A_{i-\Delta}, a_i \in A_i.$$

This metric represents the proportion of potentially converged solutions in the archive. In the early phase of a MOEA simulation, a large fraction of the non-dominated solutions in the archive  $A_{i-\Delta}$  would be dominated by the solutions in archive  $A_i$  due to evolution, thus resulting in a small fraction of surviving solutions i.e., small value of the consolidation ratio. However, significantly better solutions evolve in the later phases such that a large proportion of solutions in the archive  $A_{i-\Delta}$  remain non-dominated with respect to new solutions leading to a high consolidation ratio. In the limiting case, the consolidation ratio approaches one.

#### 4.13.10. Improvement ratio

This represents the fraction of archive  $A_{i-\Delta}$  dominated by the new solutions in archive  $A_i$ . This is computed as the ratio of the number of members in archive  $A_{i-\Delta}$  that are dominated by the solutions in archive  $A_i$  (dominated solutions) to the size of archive  $A_i$ . Mathematically,

$$IR = \frac{n(Q)}{n(A_i)}; Q = \{a_{i-\Delta} : a_{i-\Delta} \prec a_i\}, a_{i-\Delta} \in A_{i-\Delta}, a_i \in A_i.$$

The archive  $A_i$  includes all non-dominated members of archive  $A_{i-1}$  so no member of the archive  $A_i$  is dominated. The improvement ratio quantifies the extent of improvement in the quality of evolved solutions. This metric has a high value in the early phase of simulation which gradually converges to zero when convergence is achieved.

More information about these performance metrics can be obtained from [40].

## 4.14. Discrete optimization

### 4.14.1. Discrete variables

Discrete variables can have only distinct values; for example, the variable can be a plate thickness having allowable values 1.0, 2.0, 2.5, and 4.5.

### 4.14.2. Discrete optimization

A very basic method of discrete optimization would be simply evaluating all possible design and selecting the best one. This is not feasible for the general case; consider for example that 30 design variables with variables having 5 possible values of the design variable will result in  $10^{21}$  different designs. Evaluating all the possible designs is therefore not computationally feasible. Note that 30 design variables describe a design space with  $10^9$  quadrants, so finding the quadrant containing the optimum design is a hard problem. The quadrant containing the optimal design can be found using a gradient based search direction, but discrete optimization problems are not convex, which means that gradient based search directions may lead to local optima. The LS-OPT discrete optimization methodology using LFOPC therefore use gradient based search in conjunction with random search methods. The optimal design found in this manner, cannot be shown to be uniquely the global optimum, but is considered the (practical) optimum because it is known that it is highly unlikely that a better design will be found.

The cost of the discrete optimization is kept affordable by doing the optimization using the values from a response surface approximation. The accuracy of the response surface or metamodel is improved using a sequential strategy described in a later section.

### 4.14.3. Mixed-discrete optimization

The discrete variables can be used together with continuous variables. This is called mixed-discrete optimization.

The steps followed to compute the mixed-discrete optimum are:

1. Consider all the discrete variables to be continuous and optimize using the gradient based design optimization package. This continuous optimum found is used as the starting design in the next phase.

2. Discrete optimization is done considering only the discrete variables with the continuous variables frozen at the values found in the previous phase.
3. Continuous optimization is done considering only the continuous variables and with the discrete variables frozen at the values found in the previous phase.

#### 4.14.4. Discrete optimization algorithm: genetic algorithm

A GA (genetic algorithm, Section 4.8) is used to do the discrete optimization. A GA mimics the evolutionary process selecting genetic strings. In a GA, the design variable values are coded up into data structure similar to genetic strings. New generations of designs are obtained by combining portions of the genetic strings of the previous generation of designs. Designs that have relatively better values of the objective function have a better chance to contribute a portion of its genetic string to the next generation.

#### 4.14.5. Objective function for discrete optimization

The discrete optimization algorithm used can only consider an objective function (no constraints); the constraints specified by the user are therefore incorporated into this objective function. The resulting objective function has two different behaviors:

1. *A feasible design exists.* In this case all infeasible designs (those violating the constraints) are simply rejected, and only feasible designs are considered inside the optimization algorithm. The objective function used is simply that specified by the user.
2. *A feasible design does not exist.* If the search for the best feasible designs fails due to a lack of feasible designs, then a search is done for the least infeasible constraint. The objective function is a

scaled sum of the constraint violations:  $\sum \frac{|\text{constraint}_i - \text{Bound}_i|}{|\text{Bound}_i|}$  with the summation done over all the violated constraints.

#### 4.14.6. Sequential strategy

The discrete and the mixed-discrete optimization are done using the response values from the response surfaces or metamodels. The accuracy of the response surface or metamodels is therefore very important. The accuracy of the metamodels is improved by a sequential response surface method (SRS) (see Section 4.6), in which the size of the subregion over which the designs are evaluated are reduced until convergence. Reducing the size of the subregion is the best known method of obtaining accuracy for optimizing using metamodels.

Discrete optimization introduces the concern that a discrete variable value may not be on the edge of the subregion selected by the SRS algorithm. The SRS algorithm was therefore modified to use closest discrete values outside the subregion. This implies that the subregion cannot be smaller than the distance between two successive discrete values.

### 4.15. Summary of the optimization process

The following tasks may be identified in the process of an optimization cycle using response surfaces.

*Table 4-1: Summary of optimization process*

Item	Input	Output
DOE	Location and size of the subregion in the design space. The experimental design desired. An approximation order. An affordable number of points.	Location of the experimental points.
Simulation	Location of the experimental points. Analysis programs to be scheduled.	Responses at the experimental points.
Build response surface	Location of the experimental points. Responses at the experimental points. Function types to be fitted.	The approximate functions (response surfaces). The goodness-of-fit of the approximate functions at the construction points.
Check adequacy	The approximate functions (response surfaces). The location of the check points. The responses at the check points.	The goodness-of-fit of the approximate functions at the check points.
Optimization	The approximate functions (response surfaces). Bounds on the responses and variables.	The approximate optimal design. The approximate responses at the optimal design. Pareto optimal curve data.

Two approaches may be taken:

#### 4.15.1. Convergence to an optimal point

- First-order approximations.

Because of the absence of curvature, it is likely that perhaps 5 to 10 iterations may be required for convergence. The first-order approximation method turns out to be robust thanks to the sequential approximation scheme that addresses possible oscillatory behavior. Linear approximations may be rather inaccurate to study trade-off, i.e., in general they make poor global approximations, but this is not necessarily true and must be assessed using the error parameters.

- Second-order approximations.

Due to the consideration of curvature, a sequential quadratic response surface method is likely to be more robust, but can be more expensive, depending on the number of design variables.

- Other approximations.

Neural networks (Section 3.1) and Radial Basis Function networks (Section 3.1.3) provide good approximations when many design points are used. A suggested approach is to start the optimization procedure in the full design space, with the number of points at least of the order of the minimum required for a linear approximation. To converge to an optimum, use the iterative scheme with domain reduction as with any other approximations, but choose to update the experimental design and response surfaces after each iteration (this is the default method for non-polynomial approximations). The metamodel will be built using the total number of points.

See Section 4.5 on sequential strategies for optimization and design exploration.

## 4.16. REFERENCES

- [1] Forsberg, J. *Simulation Based Crashworthiness Design – Accuracy Aspects of Structural optimization using Response Surfaces*. Thesis No. 954. Division of Solid Mechanics, Department of Mechanical Engineering, Linköping University, Sweden, 2002.
- [2] Luenberger, D.G. *Linear and Nonlinear Programming*. Second Edition. Addison Wesley, 1984.
- [3] Arora, J.S. Sequential linearization and quadratic programming techniques. In *Structural Optimization: Status and Promise*, Ed. Kamat, M.P., AIAA, 1993.
- [4] Thanedar, P.B., Arora, J.S., Tseng, C.H., Lim, O.K., Park, G.J. Performance of some SQP algorithms on structural design problems. *International Journal for Numerical Methods in Engineering*, 23, pp. 2187-2203, 1986.
- [5] Snyman, J.A. The LFOPC leap-frog algorithm for constrained optimization. *Comp. Math. Applic.*, 40, pp. 1085-1096, 2000.
- [6] Barthelemy, J.-F. M. Function Approximation. In *Structural Optimization: Status and Promise*, Ed. Kamat, M.P., 1993.
- [7] Box., G.E.P., Draper, N.R. *Empirical Model Building and Response Surfaces*. Wiley, New York, 1987.
- [8] Hajela, P., Berke L. Neurobiological computational models in structural analysis and design. *Proceedings of the 31<sup>st</sup> AIAA/ ASME/ ASCE/ AHS/ ASC Structures, Structural Dynamics and Materials Conference*, Long Beach, CA, April, 1990.
- [9] Snyman, J.A. An improved version of the original leap-frog dynamic method for unconstrained minimization LFOP1(b). *Appl. Math. Modelling*, 7, pp. 216-218, 1983.
- [10] Holland, J.H., *Adaptation in Natural and Artificial Systems*. MIT Press, 1992.
- [11] Goldberg, D.E., *Genetic Algorithms in Search, Optimization and Machine Learning*. Addison-Wesley Publishing Company, 1989.
- [12] Deb, K., Agrawal, R.B., Simulated binary crossover for continuous search space. *Complex Systems*, 9, 115-148, 1995.
- [13] Deb, K., Beyer, H.-G., Self adaptive genetic algorithms with simulated binary crossover. *Evolutionary Computation Journal*, 9(2), 197-221, 2001.
- [14] Eshelman, L.J., Schaffer, J.D., Real-coded genetic algorithms and interval-schemata. In *Foundations of Genetic Algorithms-2*. San Mateo, CA: Morgan Kaufman, 187-202, 1993.

- [15] Stander, N., Craig, K.J. On the robustness of a simple domain reduction scheme for simulation-based optimization, *Engineering Computations*, 19(4), pp. 431-450, 2002.
- [16] Stander, N. Goel, T. Metamodel sensitivity to sequential sampling strategies in crashworthiness design. *Proceedings of the 12<sup>th</sup> AIAA/ISSMO Multidisciplinary Analysis and Optimization Conference, Victoria, British Columbia, Canada, Sep 10-12, 2008. Submitted.*
- [17] Deb, K., *Multiobjective Optimization using Evolutionary Algorithms*, Wiley Chichester UK, 2001.
- [18] Coello, C.A.C., *Evolutionary Algorithms for Solving Multi-Objective Problems* (Genetic and Evolutionary Computation), Springer, 2007.
- [19] Miettinen, K.M., *Nonlinear Multi Objective Optimization*, Kluwer, 1999.
- [20] Deb, K., Pratap, A., Agarwal, S., Meyarivan, T., A fast and elitist multi-objective genetic algorithm: NSGA-II. *IEEE Transaction on Evolutionary Computation*, 6(2), 181-197, 2002. an earlier version was presented in *Parallel Problem Solving from Nature VI Conference*, Paris, France, Sept 2000.
- [21] Goel, T., Vaidyanathan, R., Haftka, R.T., Queipo, N.V., Shyy, W., Tucker, K., Response surface approximation of Pareto optimal front in multi-objective optimization. *Computer Methods in Applied Mechanics and Engineering*, 196(4-6), 879-893, 2007. (also presented at *10<sup>th</sup> AIAA/ISSMO Multidisciplinary Analysis and Optimization Conference*, September 2004, Albany, NY).
- [22] Metropolis, N., Rosenbluth, A.W., Rosenbluth, M.N., Teller, A.H., Teller, E., Equation of state calculations by fast computing machines, *Journal of Chemical Physics*, 21(6), pp. 1087-1092, 1953.
- [23] Kirkpatrick, S. Gelatt, C.D., Vecchi, M.P. *Science*, 220, pp. 671-680, 1983.
- [24] Pincus, M., A Monte Carlo method for the approximate solution of certain types of constrained optimization problems, *Operations Research*, 18, pp. 1225-1228, 1970.
- [25] Cerny, V., A thermodynamical approach to the travelling salesman problem: An efficient simulation algorithm, Report, Bratislave, Czech Republic, Comenius University.
- [26] Morris, M., Mitchell, T. Exploratory design for computer experiments. *Journal of Statistical Planning Inference*, 43, pp. 381-402, 1995.
- [27] Ingber, L. Very fast simulated re-annealing, *Mathematical Computer Modeling*, 12, pp. 967-983, 1989.
- [28] Ingber, L., Adaptive simulated annealing (ASA), [ftp.alumni.caltech.edu: /pub/ingber/ASA.tar.gz], Lester Ingber Research, McLean VA, 1993.
- [29] Schuur, P.C. Classification of acceptance criteria for the simulated annealing algorithm. *Mathematics of Operations Research*, 22(2), pp.266-275, 1997.
- [30] Ingber, L., Adaptive simulated annealing: Lessons learned, *Journal of Control and Cybernetics*, 25, pp. 33-54, 1996.
- [31] Basu, A., Frazer, L.N. Rapid determination of the critical temperature in simulated annealing inversion, *Science*, pp. 1409-1412, 1990.
- [32] Geman, S., Geman, D., Stochastic relaxation, Gibbs distribution, and the Bayesian restoration in images, *IEEE Transactions of Pattern Analysis and Machine Intelligence*, 6(6), pp. 721-741, 1984.
- [33] Szu, H., Hartley, R., Fast simulated annealing, *Physics Letters A*, 122 (3-4), pp. 157-162, 1987.
- [34] van Laarhoven, P.J.M., Aarts, E.H.L., *Simulated annealing: Theory and applications*, Dordrecht, The Netherlands, D. Reidel, 1987.
- [35] Bounds, D.G. New optimization methods from physics and biology. *Nature*, 329, pp.215-218, 1987.
- [36] Kennedy J, Eberhart RC, "Particle swarm optimization", *Proceedings of the IEEE International Conference on Neural Networks*, Perth Australia, Vol. 4, pp. 1942-1948, 1995.
- [37] Schutte JF, *Applications of Parallel Global Optimization to Mechanics Problems*, PhD Thesis, University of Florida, Gainesville, 2005.

- [38] Chiu P-W, Bloebaum CL, Hyper-Radial Visualization (HRV) with weighted preferences for multi-objective decision making. *Proceedings of the 12<sup>th</sup> AIAA/ISSMO Multidisciplinary Analysis and Optimization Conference*, 10-12 September 2008, Victoria, British Columbia, Canada.
- [39] Kohonen T, Self-Organizing Maps, 3<sup>rd</sup> edition, Springer, Heidelberg, 2001.
- [40] Goel T, Stander N, A non-dominance based online stopping criterion for multi-objective evolutionary algorithms, *International Journal of Numerical Methods in Engineering*, doi: 10.1002/nme.2009.

# 5. Applications of Optimization

## 5.1. Multicriteria design optimization

A typical design formulation is somewhat distinct from the standard formulation for mathematical optimization (Eq. 2.3). Most design problems present multiple objectives, design targets and design constraints. There are two ways of solving multicriteria design optimization problems.

The first method, discussed in Section 4.9, focused on finding multiple trade-offs, known as Pareto optimal solutions, using multi-objective genetic algorithms. The advantage of this method is that one can find many trade-off designs and the designer does not have to a priori determine the preference structures.

In the second method, the standard mathematical programming problem is defined in terms of a single objective and multiple constraints. The standard formulation of Eq. (2.3) has been modified to represent the more general approach as applied in LS-OPT.

Minimize the function

$$p[\mathbf{f}(\mathbf{x})] \tag{5-1}$$

subject to the inequality constraint functions

$$L_j \leq g_j(\mathbf{x}) \leq U_j; \quad j = 1, 2, \dots, m.$$

The preference function  $p$  can be formulated to incorporate target values of objectives.

Two methods for achieving this are given:

### 5.1.1. Euclidean distance function

Designs often contain objectives that are in conflict so that they cannot be achieved simultaneously. If one objective is improved, the other deteriorates and *vice versa*. The preference function  $p[\mathbf{f}(\mathbf{x})]$  combines various objectives  $f_i$ . The Euclidean distance function allows the designer to find the design with the smallest distance to a specified set of target responses or design variables:



$$p = \sqrt{\sum_{i=1}^p W_i \left[ \frac{f_i(\mathbf{x}) - F_i}{\Gamma_i} \right]^2} \quad (5-2)$$

The symbols  $F_i$  represent the target values of the responses. A value  $\Gamma_i$  is used to normalize each response  $i$ . Weights  $W_i$  are associated with each quantity and can be chosen by the designer to convey the relative importance of each normalized response.

### 5.1.2. Maximum distance

Another approach to target responses is by using the maximum distance to a target value

$$p = \max_i \left[ \frac{|f_i(\mathbf{x}) - F_i|}{|\Gamma_i|} \right]. \quad (5-3)$$

This form belongs to the same category of preference functions as the Euclidean distance function [1] and is referred to as the Tchebysheff distance function. A general distance function for target values  $F_i$  is defined as

$$p = \left[ \sum_{i=1}^p \left( \frac{|f_i(\mathbf{x}) - F_i|}{|\Gamma_i|} \right)^r \right]^{1/r}. \quad (5-4)$$

with  $r = 2$  for the Euclidean metric and  $r \rightarrow \infty$  for the min-max formulation (Tchebysheff metric).

The approach for dealing with the Tchebysheff formulation differs somewhat from the explicit formulation.

The alternative formulation becomes:

$$\text{Minimize } e \quad (5-5)$$

subject to

$$\frac{F_i}{\Gamma_i} - (1 - \alpha_{jL})e \leq \frac{f_i(\mathbf{x})}{\Gamma_i} \leq \frac{F_i}{\Gamma_i} + (1 - \alpha_{jL})e; \quad i = 1, \dots, p, \quad j = 1, \dots, m$$

$$e \geq 0.$$

In the above equation,  $\Gamma_i$  is a normalization factor,  $e$  represents the constraint violation or target discrepancy and  $\alpha$  represents the strictness factor. If  $\alpha = 0$ , the constraint is slack (or soft) and will allow violation. If  $\alpha = 1$ , the constraint is strict (or hard) and will not allow violation of the constraint.

The effect of distinguishing between strict and soft constraints on the above problem is that the maximum violation of the soft constraints is minimized. Because the user is seldom aware of the feasibility status of the design problem at the start of the investigation, the solver will automatically solve the above problem

first to find a feasible region. If the solution to  $e$  is zero (or within a small tolerance) the problem has a feasible region and the solver will immediately continue to minimize the design objective using the feasible point as a starting point.

A few points are notable:

1. The variable bounds of both the region of interest and the design space are always hard. This is enforced to prevent extrapolation of the response surface and the occurrence of impossible designs.
2. Soft constraints will always be *strictly* satisfied if a feasible design is possible.
3. If a feasible design is not possible, the most feasible design will be computed.
4. If feasibility must be compromised (there is no feasible design), the solver will automatically use the slackness of the soft constraints to try and achieve feasibility of the hard constraints. However, even when allowing soft constraints, there is always a possibility that some hard constraints must still be violated. In this case, the variable bounds could be violated, which is highly undesirable as the solution will lie beyond the region of interest and perhaps beyond the design space. If the design is reasonable, the optimizer remains robust and finds such a compromise solution without terminating or resorting to any specialized procedure.

Soft and strict constraints can also be specified for search methods. If there are feasible designs with respect to hard constraints, but none with respect to all the constraints, including soft constraints, the most feasible design will be selected. If there are no feasible designs with respect to hard constraints, the problem is ‘hard-infeasible’ and the optimization terminates with an error message.

In the following cases, the use of the Min-Max formulation can be considered:

1. Minimize the maximum of several responses, e.g. minimize the maximum knee force in a vehicle occupant simulation problem. This is specified by setting both the knee force constraints to have zero upper bounds. The violation then becomes the actual knee force.
2. Minimize the maximum design variable, e.g. minimize the maximum of several radii in a sheet metal forming problem. The radii are all incorporated into composite functions, which in turn are incorporated into constraints which have zero upper bounds.
3. Find the most feasible design. For cases in which a feasible design region does not exist, the user may be content with allowing the violation of some of the constraints, but is still interested in minimizing this violation.

## 5.2. Multidisciplinary design optimization

There is increasing interest in the coupling of other disciplines into the optimization process, especially for complex engineering systems like aircraft and automobiles [2]. The aerospace industry was the first to embrace multidisciplinary design optimization (MDO) [3], because of the complex integration of aerodynamics, structures, control and propulsion during the development of air- and spacecraft. The automobile industry has followed suit [4]. In [4], the roof crush performance of a vehicle is coupled to its

Noise, Vibration and Harshness (NVH) characteristics (modal frequency, static bending and torsion displacements) in a mass minimization study.

Different methods have been proposed when dealing with MDO. The conventional or standard approach is to evaluate all disciplines simultaneously in one integrated objective and constraint set by applying an optimizer to the multidisciplinary analysis (MDA), similar to that followed in single-discipline optimization. The standard method has been called multidisciplinary feasible (MDF), as it maintains feasibility with respect to the MDA, but as it does not imply feasibility with respect to the disciplinary constraints, is has also been called fully integrated optimization (FIO). A number of MDO formulations are aimed at decomposing the MDF problem. The choice of MDO formulation depends on the degree of coupling between the different disciplines and the ratio of shared to total design variables [5]. It was decided to implement the MDF formulation in this version of LS-OPT as it ensures correct coupling between disciplines albeit at the cost of seamless integration being required between different disciplines that may contain diverse simulation software and different design teams.

In LS-OPT, the user has the capability of assigning different variables, experimental designs and job specification information to the different solvers or disciplines. The file locations in Version 2 have been altered to accommodate separate `Experiments`, `AnalysisResults` and `DesignFunctions` files in each solver's directory. An example of job-specific information is the ability to control the number of processors assigned to each discipline separately. This feature allows allocation of memory and processor resources for a more efficient solution process.

Refer to the user's manual (Section 19.1) for the details of implementing an MDO problem. There is one crashworthiness-modal analysis case study in the examples chapter (Section 22.6).

### 5.3. System identification using nonlinear regression

System identification is a general term used to describe the mathematical tools and algorithms that build dynamical models such as systems or processes from measured data. The methodology used in LS-OPT consists of a nonlinear regression procedure to optimize the parameters of a system or material. This procedure minimizes the errors with respect to given experimental results. Two formulations for system identification can be used. The first uses the mean squared error (MSE) as the minimization objective, while the second, the Min-Max formulation, uses the auxiliary problem formulation to minimize the maximum residual. The MSE approach is commonly used for system identification and has been automated using a single command. The two formulations are outlined below.

#### 5.3.1. Ordinate-based Curve Matching

Figure 5-1 shows a graph containing curve  $f(\mathbf{x}, z)$  and points  $G_p(z)$ . The points can be interconnected to form a curve  $G(z)$ .  $f$  is a computed response curve (e.g. stress or force history) computed at a point  $\mathbf{x}$  in the parameter space. The variables  $\mathbf{x}$  represent unknown parameters in the model. System (e.g. automotive airbag or dummy model) or material constants are typical of parameters used in constructing finite element models. The independent state variable  $z$  can represent time, but also any other response type such as strain

or deformation. The target curve  $G$  is constant with respect to  $\mathbf{x}$  and typically represents a test result (e.g. stress vs. strain or force vs. deformation).  $f$  may not be readily available from the analysis code if  $z$  does not represent time. In this case  $f$  must first be constructed using a “crossplot” feature (see Section 14.1.1) and the curve  $z(t)$  to obtain a plot that is comparable to  $G$ . Each function  $f(x, z_p)$  is internally represented by a response surface so that a typical curve  $f(x, z)$  is represented by  $P$  internal response surfaces.

In Figure 5-1, seven regression points are shown. The residuals at these points are combined into a Mean Squared Error norm:

$$\varepsilon = \frac{1}{P} \sum_{p=1}^P W_p \left( \frac{f_p(\mathbf{x}) - G_p}{s_p} \right)^2 = \frac{1}{P} \sum_{p=1}^P W_p \left( \frac{e_p(\mathbf{x})}{s_p} \right)^2 \quad (5-6)$$

**Figure 5-1: Entities in Mean Squared Error formulation**

The MSE norm is based on a series of  $P$  regression points beginning at the start point  $z_1$  and terminating at the end point  $z_P$  (see Figure 5-1). The  $s_p, p=1, \dots, P$  are residual scale factors and the  $W_p, p=1, \dots, P$  are weights applied to the square of the scaled residual  $(f_p - G_p) / s_p$  at point  $p$ .

The application of optimization to system identification is demonstrated in Section 22.5.

### 5.3.2. Curve Mapping

A major difficulty with ordinate-based curve matching is that steep parts of the curve are difficult to incorporate in the matching. Failure material models typically have the characteristic of a steep decline of the stress-strain curve towards the end of the curve while steep curves also feature in models in which part

of the behavior (typically the leading part of the curve) is linear. These kinds of problems present a strong case for incorporation of the abscissa into the curve-matching metric.

A related problem with ordinate-based matching is that the ranges of the computed and target curves often do not coincide horizontally so that some of the points are ignored. It may even happen that at an interim stage of the optimization, the two curves do not share any vertical range overlap (there is not a single vertical line which will cross both the computed and the target curves). This type of problem may cause instability of the computation because it becomes impossible to quantify the error.

A third problem is that hysteretic curves (curves with more than one possible  $y$ -value for some of the  $x$ -values) cannot be quantified because of the non-uniqueness of the ordinate values of the computed curve with respect to the target curve. I.e. a vertical line may cross the same curve more than once. A logical approach to comparison of the two curves is to map one of the curves onto the other. Two questions which immediately arise are how to scale the curves and how to match two curves of unequal length. Scaling is particularly important since scale changes have an effect on the distances between the two curves. In many cases (e.g. stress vs. strain) there could be several orders of magnitude difference between the values on the abscissa and those of the ordinate.

The mathematical literature provides some ideas on curve matching approaches. Two commonly used metrics for curve matching are the *Hausdorff* [6] and *Fréchet* [7] distances. The Hausdorff distance measures the mismatch between two point sets so is therefore not suitably general for curve matching as there is no continuous point order. For instance it would not be able to handle a hysteretic curve match. The Fréchet distance is better suited for curve matching because it takes the continuity of the curves into account. The Fréchet distance is formally defined as:

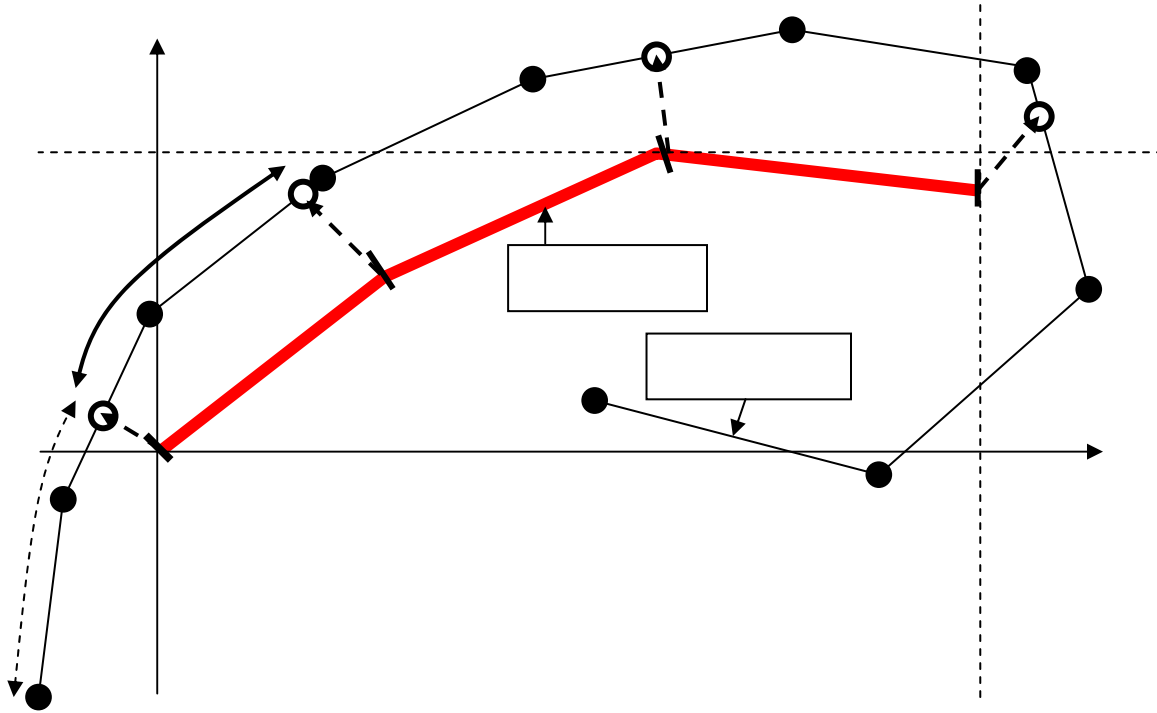
$$Fr(P, Q) = \inf_{\alpha, \beta} \max_{t \in [0,1]} \|P(\alpha(t)) - Q(\beta(t))\|$$

where  $P$  and  $Q$  are polygonal curves,  $t \in [0,1]$  represents a position on each curve. The parameters  $\alpha$  and  $\beta$  are used to parameterize the distance whereas we can think of  $t$  as “time”. The analogy is that of a dog walking along the one curve and the dog’s owner walking along the other connected by a leash. Both walk continuously and monotonically along the curve from the start point to the end point and can vary their velocities according to  $\alpha$  and  $\beta$ . The Fréchet distance is the length of the shortest leash that is sufficient for traversing both curves in this manner.

In LS-OPT we map the points of the one curve onto the second curve and compute the volume (area) between the two curves. When both curves are normalized, this typically yields a mismatch error with value much less than 1 for two reasonably matching curves.

A significant problem is that it is not appropriate to map entire curves to one another. A practical reason could be that the test curve, which could be the result of digital output from an experiment, is essentially unedited and therefore contains superfluous points unrelated to the actual behavior of the model. It may also be that the test curve represents only part of the response, perhaps because a full curve could not be obtained from the test. In parameter identification this issue becomes particularly critical as curves are typically computed at widely distributed points throughout the parameter space during the optimization process. This potential disparity of curve length requires partial mapping of the two curves.

The steps for computing the curve mismatch are described in full detail below. The reader should refer to Figure 20 which shows a test curve (in thick red) mapped on to a computed curve. The prime symbol (') is used to denote the curve on which the test curve is being mapped while the double prime symbol (") is used to denote the finally mapped curve. The test curve is shown inside its smallest bounding box, the boundaries of which are used to normalize the curve. Hence the normalized curve  $a$  is in the  $[(0,0),(1,1)]$  range.



**Figure 2:** Partial curve mapping of Curve  $a$  (in red) to Curve  $a'$  with offset. The result is Curve  $a''$ . The solid points represent the original vertices of  $a'$  whereas the open circles represent the mapped points representing  $a''$ . Curves  $a$  and  $a'$  are both normalized to the bounding box of  $a$ .

The algorithm for computing the curve mismatch error is as follows:

1. Normalize the  $m$  point coordinates  $i$  of the *target* curve  $A$  to its smallest bounding box to create Curve  $a$ . See Figure 1.

$$\xi_i = \frac{X_i - X_{\min}}{X_{\max} - X_{\min}} \quad \eta_i = \frac{Y_i - Y_{\min}}{Y_{\max} - Y_{\min}}$$

$$X_{\min} = \min_k X_k ; \quad X_{\max} = \max_k X_k ; \quad Y_{\min} = \min_k Y_k ; \quad Y_{\max} = \max_k Y_k$$

2. Normalize the  $n$  point coordinates  $j$  of the *computed* curve  $A'$  to the smallest bounding box of  $A$  to create curve  $a'$ . See Figure 1.

$$\xi_j' = \frac{x_j - X_{\min}}{X_{\max} - X_{\min}} \quad \eta_j' = \frac{y_j - Y_{\min}}{Y_{\max} - Y_{\min}}$$

3. Compute  $S$ , the total polygon length of  $a$ . Also compute the individual segment lengths  $\delta S_i$ :

$$\delta S_i = \sqrt{(\xi_i - \xi_{i-1})^2 + (\eta_i - \eta_{i-1})^2}; \quad i = 2, 3, \dots, m$$

Here a segment is defined as a part of the curve between two consecutive points, connected by a straight line.

4. Scale each segment length to the total curve length  $S$ :

$$\tilde{s}_i = \delta S_i / S; \quad i = 2, 3, \dots, m$$

5. Compute  $T$ , the total polygon length of  $a'$ .

6. If  $S > T$ , rename  $a'$  to  $a$  and  $a$  to  $a'$ . Hence  $a$  will always be shorter than  $a'$ .

7. Define an *offset* as a starting point of a curve section of total length  $S$  on curve  $a'$ . The offset =  $\lambda_p$  will be varied over  $p = 1$  to  $P$  in order to “slide” Curve  $a$  along Curve  $a'$ .  $\lambda \in [0, T - S]$ . Assume  $P$  increments in this interval so that each increment has size  $\Delta\lambda = \frac{T - S}{P}$ .

8. Set  $\lambda_p = \lambda_{p-1} + \Delta\lambda$  to create a new section of the computed curve and create point coordinate pairs by mapping each point of curve  $a$  to curve  $a'$ . A typical curve segment  $i$  on  $a'$  which corresponds to a segment  $i$  on  $a$  has length  $\delta T_i = \delta S_i$  (see Fig. 1). This creates a new set of point pairs  $a''$ . *The assumption that the length of the mapped section of the long curve is equal to the length of the short curve is critical to the success of the method.*

9. Compute the discrepancy (mismatch error) between the two curves  $a$  and  $a''$ . This is done by summing the *volumes*  $v_i$  representing the individual segment errors. First compute the distances between the point pairs:

$$d_i = \sqrt{(\xi_i'' - \xi_i)^2 + (\eta_i'' - \eta_i)^2}$$

Then compute the volume component of each segment. (Note for  $m$  points, there are  $m-1$  segments.)

$$v_i = \frac{d_i + d_{i-1}}{2} \times \tilde{s}_i; \quad v_1 = 0; \quad i = 2, 3, \dots, m;$$

Then sum the volumes to get the final discrepancy:

$$\varepsilon_p = \sum_{i=1}^m v_i$$

10. Set  $p = p+1$  and repeat from point 8.

11. Find the distance  $\varepsilon = \min_p \varepsilon_p$ . This is the best match between the curves  $\mathbf{a}$  and  $\mathbf{a}'$ .

### 5.3.3. Minimizing the maximum residual (Min-Max)

In this formulation, the deviations from the respective target values are incorporated as constraint violations, so that the optimization problem for parameter identification becomes:

$$\text{Minimize } e, \quad (5-7)$$

subject to

$$\left| \frac{f_p(\mathbf{x}) - G_p}{s_p} \right| \leq e; \quad p = 1, \dots, P$$

$$e \geq 0.$$

This formulation is automatically activated in LS-OPT when specifying both the lower and upper bounds of  $f_p/s_p$  equal to  $G_p/s_p$ . There is therefore no need to define an objective function. This is due to the fact that an auxiliary problem is automatically solved internally whenever an infeasible design is found, ignoring the objective function until a feasible design is obtained. When used in parameter identification, the constraint set is in general never completely satisfied due to the typically over-determined systems used.

Since  $s_p$  defaults to 1.0, the user is responsible for the normalization in the maximum violation formulation. This can be done by e.g. using the target value to scale the response  $f(\mathbf{x})$  so that:

$$\left| \frac{f_p(\mathbf{x})}{G_p} - 1 \right| \leq e; \quad p = 1, \dots, P$$

$$e \geq 0.$$

Omitting the scaling may cause conditioning problems in some cases, especially where constraint values differ by several orders of magnitude. This option will also be automated in future versions.

### 5.3.4. Nonlinear regression: Confidence intervals

Assume the nonlinear regression model:



$$G(t) = F(t, \mathbf{x}) + \varepsilon,$$

where the measured result  $G$  is approximated by  $F$  and  $\mathbf{x}$  is a vector of unknown parameters. The nonlinear least squares problem is obtained from the discretization:

$$\min_{\mathbf{x}} \frac{1}{P} \sum_{p=1}^P (G_p - F_p(\mathbf{x}))^2,$$

is solved to obtain  $\mathbf{x}^*$ . The variance  $\sigma^2$  is estimated by

$$\sigma^2 = \frac{1}{P-n} \|G - F(\mathbf{x}^*)\|^2,$$

where  $\mathbf{F}$  is the  $P$ -vector of function values predicted by the model and  $n$  is the number of parameters. The  $100(1-\alpha)\%$  confidence interval for each  $x_i^*$  is:

$$\left( x_i : |x_i^* - x_i| \leq \sqrt{\hat{C}_{ii}} t_{P-n}^{\alpha/2} \right),$$

where

$$\hat{\mathbf{C}} := \hat{\sigma}^2 \left( (\nabla \mathbf{F}(\mathbf{x}^*))^T (\nabla \mathbf{F}(\mathbf{x}^*)) \right)^{-1},$$

and  $t_{P-n}^{\alpha/2}$  is the Student  $t$ -distribution for  $\alpha$ .

$\nabla \mathbf{F}$  is the  $P \times n$  matrix obtained from the  $n$  derivatives of the  $P$  response functions representing  $P$  points at the optimum  $\mathbf{x}$ . The optimal solution is therefore calculated first, followed by the confidence interval.

A critical issue is to ensure that  $\nabla \mathbf{F}$  is not based on a gradient obtained from a spurious response surface (e.g. occurring due to noise in the response). Monitoring convergence and selected statistical parameters such as the RMS error and  $R^2$  can help to estimate a converged result. In many cases material identification problems involve smooth functions (e.g. tensile tests) so that spurious gradients would normally not be a problem.

## 5.4. Worst-case design

Worst-case design involves minimizing an objective with respect to certain variables while maximizing the objective with respect to other variables. The solution lies in the so-called saddle point of the objective function and represents a worst-case design. This definition of a worst-case design is different to what is sometimes referred to as min-max design, where one multi-objective component is minimized while another is maximized, both with respect to the same variables.

There is an abundance of examples of worst-case scenarios in mechanical design.

One class of problems involves minimizing design variables and maximizing case or condition variables. One example in automotive design is the minimization of head injury with respect to the design variables of the interior trim while maximizing over a range of head orientation angles. Therefore the worst-case design represents the optimal trim design for the worst-case head orientation. Another example is the minimization of crashworthiness-related criteria (injury, intrusion, etc.) during a frontal impact while maximizing the same criteria for a range of off-set angles in an oblique impact situation.

Another class of problems involves the introduction of *uncontrollable* variables  $z_i, i = 1, \dots, n$  in addition to the *controlled* variables  $y_j, j = 1, \dots, m$ . The controlled variables can be set by the designer and therefore optimized by the program. The uncontrollable variables are determined by the random variability of manufacturing processes, loadings, materials, etc. Controlled and uncontrollable variables can be independent, but can also be associated with one another, i.e. a controlled variable can have an uncontrollable component.

The methodology requires three features:

1. The introduction of a constant range  $\rho$  of the region of interest for the uncontrollable variables. This constant represents the *possible variation* of each uncontrollable parameter or variable. In LS-OPT this is introduced by specifying a lower limit on the range as being equal to the initial range  $\rho$ . The lower and upper bounds of the design space are set to  $\pm\rho/2$  for the uncontrollable variables.
2. The controlled and uncontrollable variables must be separated as minimization and maximization variables. The objective will therefore be minimized with respect to the controlled variables and maximized with respect to the uncontrollable variables. This requires a special flag in the optimization algorithm and the formulation of Equation (2.1) becomes:

$$\min_y \left\{ \max_z f(\mathbf{y}, \mathbf{z}) \right\}; \quad \mathbf{y} \in \mathfrak{R}^p, \mathbf{z} \in \mathfrak{R}^q \quad (5-8)$$

subject to

$$g_j(\mathbf{y}, \mathbf{z}) \leq 0; \quad j = 1, 2, \dots, l.$$

The algorithm remains a minimization algorithm but with modified gradients:

$$\nabla_{\mathbf{y}}^{\text{mod}} := \nabla \mathbf{y},$$

$$\nabla_{\mathbf{z}}^{\text{mod}} := -\nabla \mathbf{z}.$$

For a maximization problem the min and max are switched.

3. The dependent set (the subset of  $y$  and  $z$  that are dependent on each other)  $x = y + z$  must be defined as input for each simulation, e.g. if the manufacturing tolerance on a thickness is specified as the

uncontrollable component, it is defined as a variation added to a mean value, i.e.  $t = t_{\text{mean}} + t_{\text{deviation}}$ , where  $t$  is the dependent variable.

## 5.5. Reliability-based design optimization (RBDO)\*

Reliability-based design optimization (RBDO) is the computation of an optimum design subject to probabilistic bounds on the constraints. The probabilistic bound is usually interpreted in the six-sigma context; for example, the failure of only one part in a million would be acceptable.

RBDO is currently done using First Order Second Moment (FOSM) method of computing the reliability. The requested minimum probability of failure is transformed to a number of standard deviations (sigmas) of the response, and the number of standard deviations (sigmas) is subsequently transformed into a safety margin used in the optimization process. The standard deviation of a response is computed analytically for response surfaces, and for the other metamodels and composites a second order local approximation is created to compute the standard deviation. See Section 6.4.4 for more detail regarding the First Order Second Moment (FOSM) method. The FOSM methodology is currently the default RBDO method, but more sophisticated methods may be available in future versions of LS-OPT.

Discrete variables are allowed in RBDO. The mixed-discrete optimization will be carried out considering the probabilistic bounds on the constraints.

The methods are described in more detail in Section 19.3 with an example in Section 22.2.11 illustrating the method.

Care must be taken in interpreting the resulting reliability of the responses. Accuracy can be especially poor at the tail ends of the response distribution. What constitutes engineering accuracy at the low probabilities is an open question. A definition such as six-sigma may be the best way of specifying the engineering requirement; a precise numerical value may not be meaningful. Accuracy at low probabilities requires firstly that the input data must be known accurately at these low probabilities, which may be prohibitively expensive to estimate.

## 5.6. REFERENCES

- [1] Daberkow, D.D. Mavris, D.N. An investigation of metamodeling techniques for complex systems design. *Symposium on Multidisciplinary Analysis and Design*, Atlanta, October 2002.
- [2] Lewis, K., Mistree, F. The other side of multidisciplinary design optimization: accommodating a multiobjective, uncertain and non-deterministic world. *Engineering Optimization*, 31, pp. 161-189, 1998.
- [3] Simpson, T.W. *A Concept Exploration Method for Product Family Design*. Ph.D. Thesis, Georgia Institute of Technology, 1998.

- [4] Sobieszczanski-Sobieski, J., Kodiyalam, S., Yang, R.-J. Optimization of car body under constraints of noise, vibration, and harshness (NVH), and crash. *AIAA Paper 2000-1521*, 2000.
- [5] Zang, T.A., Green, L.L., Multidisciplinary design optimization techniques: Implications and opportunities for fluid dynamics research, *AIAA Paper 99-3798*, 1999.
- [6] Rockafellar, R.T., Wets, R. J-B. *Variational Analysis*, Springer Verlag, 2005, p. 117
- [7] Alt, H. and Godau, M. Computing the Fréchet distance between two polygonal curves, *Internat. J. Comput. Geom.. Appl.*, 5:75-91, 1995.

# 6. Probabilistic Fundamentals

## 6.1. Introduction

No system will be manufactured and operated exactly as designed. Adverse combinations of design and loading variation may lead to undesirable behavior or failure; therefore, if significant variation exists, a probabilistic evaluation may be desirable.

Sources of variation are:

1. Variation in structural properties; for example: variation in yield stress.
2. Variation in the environment; for example: variation in a load.
3. Variation occurring during the problem modeling and analysis; for example: buckling initiation, mesh density, or results output frequency.

From the probabilistic analysis we want to infer:

1. Distribution of the response values.
2. Probability of failure.
3. Properties of the designs associated with failure.
  - Variable screening - identify important noise factors.
  - Dispersion factors - factors whose settings may increase variability of the responses.
4. Efficient redesign strategies.

## 6.2. Probabilistic variables

The probabilistic component of a parameter is described using a probability distribution; for example, a normal distribution. The parameter will therefore have a mean or nominal value as specified by the distribution, though in actual use the parameter will have a value randomly chosen according to the probability density function of the distribution.

The relationship between the control variables and the variance can be used to adjust the control process variables in order to have an optimum process. The variance of the control and noise variables can be used to predict the variance of the system, which may then be used for redesign. Knowledge of the interaction between the control and noise variables can be valuable; for example, information such as that the

dispersion effect of the material variation (a noise variable), may be less at a high process temperature (a control variable) can be used to selected control variables for a more robust manufacturing process.

### 6.2.1. Variable linking

A single design parameter can apply to several statistically independent components in a system; for example: one joint design may be applicable to several joints in the structure.

The components will then all follow the same distribution but the actual value of each component will differ. Each duplicate component is in effect an additional variable and will result in additional computational cost (contribute to the curse of dimensionality) for techniques requiring an experimental design to build an approximation or requiring the derivative information such as FORM. Direct Monte Carlo simulation on the other hand does not suffer from the curse of dimensionality but is expensive when evaluating events with a small probability.

Design variables can be linked to have the same expected (nominal) value, but allowed to vary independently according to the statistical distribution during a probabilistic analysis. One can therefore have one design variable associated with many probabilistic variables.

Three probabilistic associations between variables are possible:

1. Their nominal values and distributions are the same.
2. Their nominal values differ but they refer to the same distribution.
3. Their nominal values are the same but their distributions differ.

## 6.3. Basic computations

### 6.3.1. Mean, variance, standard deviation, and coefficient of variation

The mean of a set of responses is

$$\bar{y} = \frac{1}{n} \sum_{i=1}^n y_i.$$

The variance is

$$s^2 = \frac{1}{n} \sum_{i=1}^n (y_i - \bar{y})^2.$$

The standard deviation is simply the square root of the variance

$$s = \sqrt{s^2}.$$

The coefficient of variation, the standard deviation as a proportion of the mean, is computed as

$$c.o.v. = s/\bar{y}.$$

### 6.3.2. Correlation of responses

Whether a variation in displacements in one location causes a variation in a response value elsewhere is not always clear.

The covariance of two responses indicates whether a change in the one is associated with a change in the other.

$$Cov(Y_1, Y_2) = E[(Y_1 - \mu_1)(Y_2 - \mu_2)],$$

$$Cov(Y_1, Y_2) = E[Y_1 Y_2] - E(Y_1)E(Y_2).$$

The covariance can be difficult to use because it is unscaled. The standard deviation of the responses can be used for scaling. The coefficient of correlation is accordingly

$$\rho = \frac{Cov(Y_1, Y_2)}{\sigma_1 \sigma_2}.$$

The confidence interval on the coefficient of correlation is described in the next section.

### 6.3.3. Confidence intervals

The confidence interval on the mean assuming a normal distribution and using  $s^2$  as an estimate to the variance is

$$\bar{y} - t_{\alpha/2, n-1} \frac{s}{\sqrt{n}} < \mu < \bar{y} + t_{\alpha/2, n-1} \frac{s}{\sqrt{n}},$$

with  $\mu$  the mean,  $\bar{y}$  the estimate to the mean, and  $t_{\alpha/2, n-1}$  the relevant critical value of the  $t$ -distribution.

The confidence interval on the variance assuming a normal distribution and using  $s^2$  as an estimate to the variance is

$$\frac{(n-1)s^2}{\chi_{\alpha/2, n-1}^2} < \sigma^2 < \frac{(n-1)s^2}{\chi_{1-\alpha/2, n-1}^2},$$

with  $\sigma^2$  the variance and  $\chi_{\alpha/2, n-1}^2, \chi_{1-\alpha/2, n-1}^2$  the relevant critical values of the  $\chi^2$  distribution.

The confidence interval on the probability of an event is

$$\hat{p} - z_{\alpha/2} \sqrt{\frac{\hat{p}(1-\hat{p})}{n}} < p < \hat{p} + z_{\alpha/2} \sqrt{\frac{\hat{p}(1-\hat{p})}{n}},$$

with  $p$  the probability,  $\hat{p}$  the estimate to the probability, and  $z_{\alpha/2, n-1}$  the relevant critical value of the normal distribution.

The coefficient of correlation has a confidence interval of

$$\tanh \left[ \frac{1}{2} \ln \left( \frac{1+\rho}{1-\rho} \right) - \frac{t_{1-\alpha/2, N}}{\sqrt{N-3}} \right] \leq \rho \leq \tanh \left[ \frac{1}{2} \ln \left( \frac{1+\rho}{1-\rho} \right) + \frac{t_{1-\alpha/2, N}}{\sqrt{N-3}} \right].$$

## 6.4. Probabilistic methods

The reliability – the probability of not exceeding a constraint value – can be computed using probabilistic methods.

The accuracy can be limited by the accuracy of the data used in the computations as well as the accuracy of the simulations. The choice of methods depends on the desired accuracy and intended use of the reliability information.

More details on probabilistic methods can be found in, for example, the recent text by Haldar and Mahadevan [1].

### 6.4.1. Monte Carlo simulation

A Monte Carlo simulation aims to compute results with the same scatter as what will occur in practice.

Multiple analyses are conducted using values of the input variables selected considering their probability density function. The results from these analyses should have the scatter expected in practice. Under the law of large numbers the output results will eventually converge.

Applications of a Monte Carlo investigation are:

1. Compute the distribution of the responses, in particular the mean and standard deviation.
2. Compute reliability.
3. Investigate design space – search for outliers.

The approximation to the nominal value is:

$$E[f(X)] = \frac{1}{N} \sum f(X_i).$$



If the  $X_i$  are independent, the laws of large numbers allow us any degree of accuracy by increasing  $N$ . The error of estimating the nominal value is a random variable with standard deviation

$$\sigma_\theta = \frac{\sigma}{\sqrt{N}}.$$

with  $\sigma$  the standard deviation of  $f(\mathbf{x})$  and  $N$  the number of sampling points. The error is therefore unrelated to the number of design variables.

The error of estimating  $p$ , the probability of an event, is a random value with the following variance

$$\sigma_\theta^2 = \frac{p(1-p)}{N},$$

which can be manipulated to provide a minimum sampling. A suggestion for the minimum sampling size provided by Tu and Choi [2] is:

$$N = \frac{10}{P[G(x) \leq 0]}.$$

The above indicates that for a 10% estimated probability of failure; about 100 structural evaluations are required with some confidence on the first digit of failure prediction. To verify an event having a 1% probability; about a 1000 structural analyses are required, which usually would be too expensive.

A general procedure of obtaining the minimum number of sampling points for a given accuracy is illustrated using an example at the end of this section. For more information, a statistics text (for example, reference [3]) should be consulted. A collection of statistical tables and formulae such as the CRC reference [4] will also be useful.

The variance of the probability estimation must be taken into consideration when comparing two different designs. The error of estimating the difference of the mean values is a random variable with a variance of

$$\sigma_\theta^2 = \frac{\sigma_1^2}{N_1} + \frac{\sigma_2^2}{N_2},$$

with the subscripts 1 and 2 referring to the different design evaluations. The error of estimating the difference of sample proportions is a random variable with a variance of

$$\sigma_\theta^2 = \frac{p_1(1-p_1)}{N_1} + \frac{p_2(1-p_2)}{N_2}.$$

The Monte Carlo method can therefore become prohibitively expensive for computing events with small probabilities; more so if you need to compare different designs.

The procedure can be sped up using Latin Hypercube sampling, which is available in LS-OPT. These sampling techniques are described elsewhere in the LS-OPT manual. The experimental design will first be computed in a normalized, uniformly distributed design space and then transformed to the distributions specified for the design variables.

**Example:**

The reliability of a structure is being evaluated. The probability of failure is estimated to be 0.1 and must be computed to an accuracy of 0.01 with a 95% confidence. The minimum number of function evaluations must be computed.

For an accuracy of 0.01, we use a confidence interval having a probability of containing the correct value of 0.95. The accuracy of 0.01 is taken as 4.5 standard deviations large using the Tchebysheff's theorem, which gives a standard deviation of 0.0022. The minimum number of sampling points is therefore:

$$N = \frac{pq}{\sigma^2} = \frac{(0.9)(0.1)}{(0.0022)^2} = 18595.$$

Tchebysheff's theorem is quite conservative. If we consider the response to be normally distributed then for an accuracy of 0.01 and a corresponding confidence interval having a probability of containing the correct value of 0.95, a confidence interval 1.96 standard deviations wide is required. The resulting standard deviation is 0.051 and the minimum number of sampling points is accordingly:

$$N = \frac{pq}{\sigma^2} = \frac{(0.9)(0.1)}{(0.051)^2} = 3457.$$

**6.4.2. Monte Carlo analysis using metamodels**

Performing the Monte Carlo analysis using approximations to the functions instead of FE function evaluations allows a significant reduction in the cost of the procedure.

A very large number of function evaluations (millions) are possible considering that function evaluations using the metamodels are very cheap. Accordingly, given an exact approximation to the responses, the exact probability of an event can be computed.

The choice of the point about which the approximation is constructed has an influence on accuracy. Accuracy may suffer if the metamodel is not accurate close to the failure initiation hyperplane,  $G(\mathbf{x}) = 0$ . A metamodel accurate at the failure initiation hyperplane (more specifically the Most Probable Point of failure) is desirable in the cases of nonlinear responses. The results should however be exact for linear responses or quadratic responses approximated using a quadratic response surface.

Using approximations to search for improved designs can be very cost-efficient. Even in cases where absolute accuracy is not good, the technique can still indicate whether a new design is comparatively better.

The number of FE evaluations required to build the approximations increases linearly with the number of variables for linear approximations (the default being  $1.5n$  points) and quadratically for quadratic approximations (the default being  $0.75(n+2)(n+1)$  points).

### 6.4.3. Correlated variables

Considering the correlation  $Cov(Y_i, Y_j) = E[(Y_i - \mu_i)(Y_j - \mu_j)] = \Sigma_{ij}$  between variables, we construct the covariance matrix

$$\begin{bmatrix} \Sigma_{11} & \Sigma_{12} & \dots & \Sigma_{1n} \\ \Sigma_{21} & \Sigma_{22} & \dots & \Sigma_{2n} \\ \dots & \dots & \dots & \dots \\ \Sigma_{n1} & \Sigma_{n2} & \dots & \Sigma_{nn} \end{bmatrix},$$

from which we compute the eigenvalues and eigenvectors as  $\Sigma E = \lambda^2 E$  with E and  $\lambda^2$  respectively the eigenvectors and the eigenvalues of the covariance matrix.

The correlated variables are created by firstly generating independent variables and transforming them back to being correlated variables using the eigenvalues and eigenvectors of the covariance matrix

$\mathbf{X} = \lambda^1 E^1 iid^1 + \dots + \lambda^n E^n iid^n$  with  $\mathbf{X}$  the correlated variables and *iid* the independent variables. This method is only valid for normally distributed variables.

Consider a function of correlated variables  $F = \sum_{i=1}^n a_i Y_i$ ; the statistics of this functions are computed as

$$E(F) = \sum_{i=1}^n a_i \mu_i,$$

$$V(F) = \sum_{i=1}^n a_i^2 V(Y_i) + 2 \sum_{i=1}^n \sum_{j=i+1}^n a_i a_j COV(Y_i, Y_j).$$

### 6.4.4. First-Order Second-Moment Method (FOSM)

For these computations we assume a linear expansion of the response. The reliability index of a response  $G(X) < 0$  is computed as:

$$\beta = \frac{E[G(X)]}{D[G(X)]},$$

with  $E$  and  $D$  the expected value and standard deviation operators respectively. A normally distributed response is assumed for the estimation of the probability of failure giving the probability of failure as:

$$P_f = \Phi(-\beta) \text{ or } 1 - \Phi(\beta),$$

with  $\Phi(x)$  the cumulative distribution function of the normal distribution.

The method therefore (i) computes a safety margin, (ii) scale the safety margin using the standard deviations of the response, and (iii) then convert the safety margin to a probability of failure by assuming that the response is normally distributed.

The method is completely accurate when the responses are linear functions of normally distributed design variables. Otherwise the underlying assumption is less valid at the tail regions of the response distribution. Caution is advised in the following cases:

1. Nonlinear responses: Say we have a normally distributed stress responses - this implies that fatigue failure is not normally distributed and that computations based on a normal distribution will not be accurate.
2. The variables are not normally distributed; for example, one is uniformly distributed. In which case the following can have an effect:
  - A small number of variables may not sum up to a normally distributed response, even for a linear response.
  - The response may be strongly dependent on the behavior of a single variable. The distribution associated with this variable may then dominate the variation of the response. This is only of concern if the variable is not normally distributed.

Considering the accuracy of the input data, this method can be reasonable. For example, it should be common that the distribution of the input data can only be estimated using a mean and a standard deviation with a 20% error bound, in which case the results should be understood to have at the least a matching certainty. Interpreting the results in terms of a number of standard deviations can be a reasonable engineering approximation under these circumstances.

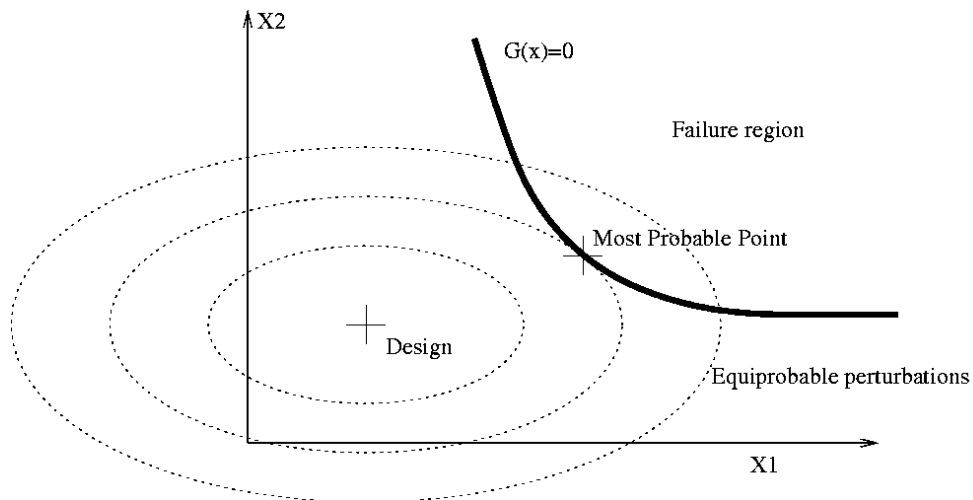
### **6.4.5. Design for six-sigma methods**

See the section for FOSM keeping in mind that the reliability index  $\beta$  is the number of standard deviations.

### **6.4.6. The most probable point**

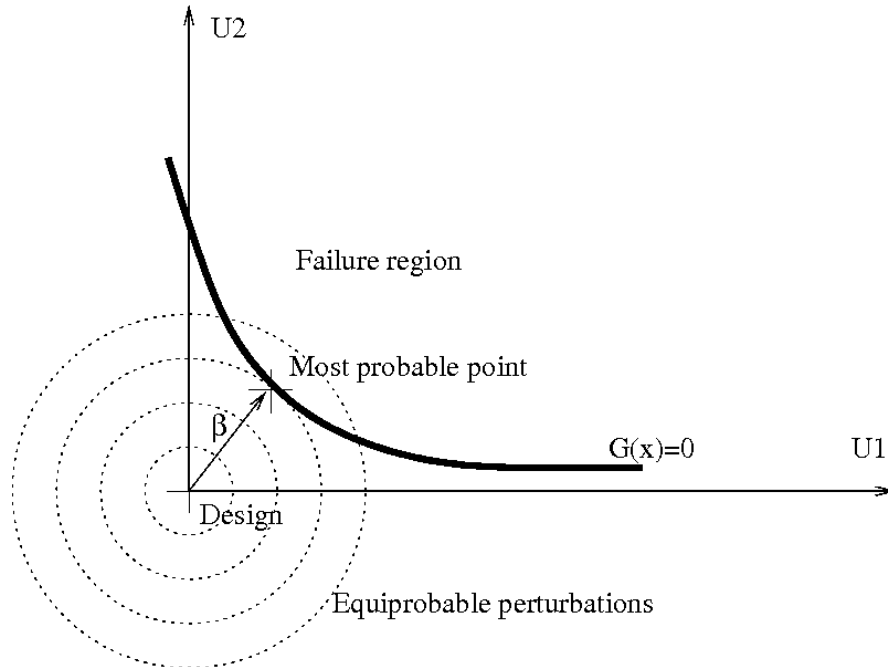
Probabilistic methods based on the most probable point of failure focus on finding the design perturbation most likely to cause failure.

To understand how these methods work, consider the limit state function  $G(\mathbf{x})$  dividing the responses into two design regions: one consisting of acceptable responses and the other of unacceptable responses. The two regions are separated by the hyperplane described by  $G(\mathbf{x})=0$ .



**Figure 6-1 Finding the most probable point of failure. The most probable point is the point on the line  $G(\mathbf{x})=0$  closest to the design in the probabilistic sense.**

We want to find the design perturbation most likely to cause the design to fail. This is difficult in the problem as shown in Figure 6-1, because all variables will not have an equal influence of the probability of failure due to differences in their distributions. In order to efficiently find this design perturbation, we transform the variables to a space of independent and standardized normal variables, the  $\mathbf{u}$ -space.



**Figure 6-2 Most probable point in the transformed space. In the transformed space the most probable point is the point on the line  $G(X)=0$  the closest to the origin.**

The transformed space is shown in Figure 6-2. The point on the limit state function with the maximum joint probability is the point the closest to the origin. It is found by solving the following optimization problem:

$$\text{Minimize: } \sqrt{\sum_{i=1}^n u_i^2}$$

$$\text{Subject to: } G(u) = 0.$$

This point is referred to as the *most probable point* (MPP) and the distance from the origin in the  $\mathbf{u}$ -space is referred to as the first-order probability index  $\beta_{\text{FORM}}$ .

The advantages of the most probable point are:

1. The MPP gives an indication of the design most likely to fail.
2. Highly accurate reliability methods utilizing an approximation around the MPP are possible.

#### 6.4.7. FORM (First Order Reliability Method)

The Hasofer-Lind transformation is used to normalize the variables:

$$u_i = \frac{x_i - \mu_i}{\sigma_i}.$$

The minimization problem is accordingly solved in the  $\mathbf{u}$ -space to find the first-order probability index  $\beta_{FORM}$ . Approximations to the responses are used to solve the optimization problem.

The probability of failure is found assuming a normally distributed response as

$$P_f = \Phi(-\beta_{FORM}),$$

with  $\Phi$  the cumulative density function of the normal distribution.

The error component of the procedure is due to (i) curvature of the constraint, (ii) the error component of the approximating function used in the computations, and (iii) the assumption of a normal distribution for the computation of failure.

The method is considered conservative considering that disregarding the curvature of the constraint results in an overestimation of the probability of failure.

#### 6.4.8. Design sensitivity of the most probable point

For a probabilistic variable we use the partial derivative as:

$$\frac{\partial P}{\partial x_i} = \frac{\partial P}{\partial \beta} \frac{\partial \beta}{\partial u_i} \frac{\partial u_i}{\partial x_i},$$

with  $\partial P/\partial \beta$  the derivative of the CDF function of the normal distribution.

For deterministic variables, which do not have a probabilistic component and therefore no associated  $\mathbf{u}$  variables:

$$\frac{\partial P}{\partial x_i} = \frac{\partial P}{\partial \beta} \frac{\partial \beta}{\partial f} \frac{\partial f}{\partial x_i},$$

with  $\partial \beta/\partial f$  taken as  $\beta/(f_{constraint} - f_{nominal})$ .

For the pathological case of being at the MPP, the vector associated with  $\beta$  vanishes and we use:

$$\frac{\partial P}{\partial x_i} = 0.4 \frac{\partial G}{\partial u_i} \frac{\partial u_i}{\partial x_i},$$

with 0.4 the relevant value derivative of the CDF function of the normal distribution.

## 6.5. Required number of simulations

### 6.5.1. Overview

A single analysis of a noisy structural event yields only a single value drawn from an unexplored population. The whole population can be explored and quantified using a probabilistic investigation if the computational cost is reasonable. The cost of this probabilistic analysis is of quite some concern for FEA results and is therefore expounded in the following subsections.

Rough rules of thumb:

- 20 FE evaluation, a maximum of 10 design variables, and a metamodel-based probabilistic analysis for design purposes
- 50 FE evaluations, about 5 design variables, and a metamodel-based probabilistic analysis for a detailed analysis of the scatter in the results and the role of the design variables
- 100 FE evaluations and a Monte Carlo analysis for very noisy behavior or a very large number of potentially significant variables. These would be cases where it is very difficult to associate the variation in results with the design variables and accordingly only quantifying the result is feasible.

### 6.5.2. Background

The required number of the simulation depends on:

1. Cost of creating an accurate metamodel
2. Cost of estimating the noise variation
3. Cost of observing low-probability events.

If the variation in the responses is mainly due to the variation of the design variables, then the cost of creating an accurate metamodel dominates. The region of interest for a robustness analysis will not be as large as to contain significant curvature; therefore a linear or preferably a quadratic response surface should suffice. In past design optimization work, the number of experiments was successfully taken to be 1.5 times the number of terms (unknowns) in the metamodel to be estimated. For a robustness analysis, being conservative at this point in time, a value of twice the number of terms is recommended. The number of terms for a linear model is  $k+1$  with  $k$  the number of design parameters. The number of terms for a quadratic response surface is  $(k+1)(k+2)/2$ .

The variation in the responses may not be mainly due to the variation of the design variables. In this case, enough experiments must be conducted to estimate this noise variation with sufficient accuracy. This cost is additional to the cost of creating the metamodel. The number of experiments required will differ considering the criteria for accuracy used. For example, we can require the error of estimating the noise variation to be less than 10%; however, this requires about 150 experiments, which may be too expensive. Considering the practical constraints for vehicle crash analysis, useful results can be obtained with 25 or more degrees of freedom of estimating the noise variation. This gives a situation where the error bound on the standard



deviation is about 20% indicating that it is becoming possible to distinguish the six sigma events from five sigma events.

For design purposes, the variation of the responses and the role of the design variables are of interest. High accuracy may be impossible due to lack of information or unreasonable computational costs. A metamodel-based investigation and 20 FE evaluations can achieve:

1. Investigate up to 10 variable
2. Quantify the contribution of each variable
3. Estimate if the scatter in results is admissible.

If the scatter in FE results is large, then the FE model must be improved, the product redesigned, or a more comprehensive probabilistic investigation performed. The study should indicate which is required.

A study can be augmented to re-use the existing FE evaluations in a larger study.

If higher accuracy is required, then for approximately 50 simulations one can compute:

- Better quantification of the role of the design variables: Investigate the effect of about five variables if a quadratic or neural network approximation is used or about 10 variables using linear approximations.
- Higher accuracy and better understanding of the scatter in the results. Predict effect of frequently occurring variation with a rare chance of being in error. Outliers may occur during the study and will be identified as such for investigation by the analyst. Structural events with a small (5% to 10%) probability of occurring might however not be observed.

The accuracy of these computations must be contrasted to the accuracy to which the variation of the design parameters is known. These limits on the accuracy, though important for the analyst to understand, should not prohibit useful conclusions regarding the probabilistic behavior of the structure.

### **6.5.3. Competing role of variance and bias**

In an investigation the important design variables are varied while other sources are kept at a constant value in order to minimize their influence. In practice the other sources will have an influence. Distinguishing whether a difference in a response value is due to a deterministic effect or other variation is difficult, because both always have a joint effect in the computer experiments being considered.

In general [4] the relationship between the responses  $y$  and the variables  $\mathbf{x}$  is:

$$y = f(\mathbf{x}) + \delta(\mathbf{x}) + \varepsilon,$$

with  $f(\mathbf{x})$  the metamodel;  $\delta(\mathbf{x}) = \eta(\mathbf{x}) - f(\mathbf{x})$ , the bias, the difference between the chosen metamodel and the true functional response  $\eta(\mathbf{x})$ ; and  $\varepsilon$  the random deviation.

The bias (fitting error) and variance component both contribute to the residuals. If we compute the variance of the random deviation using the residuals then the bias component is included in our estimate of the variance. The estimate of the variance is usually too large in the case of a bias error.

The bias error is minimized by:

1. Choosing the metamodel to be the same as the functional response. The functional response is however unknown. A reliable approach in the presence of noise is difficult to establish. In particular, metamodels that can fit exactly to any set of points will fit to the noise thus erroneously stating that the random deviation is zero; inflexible metamodels will ascribe deterministic effects to noise.
2. Reducing the region of interest to such a size that the difference between metamodel and true functional response is not significant.
3. Large number of experimental points. This strategy should be used together with the correct metamodel or a sufficiently small region of interest.

The recommended approach is therefore to use a linear or quadratic response over a subregion small enough that the bias error should be negligible.

#### 6.5.4. Confidence interval on the mean

For multiple regression, the  $100(1-\alpha)\%$  confidence limits on the mean value at  $\mathbf{X}_0$  are obtained from

$$Y_0 \pm t_{\alpha/2, n-p} s_{n-p} \sqrt{\mathbf{X}_0 (\mathbf{X}'\mathbf{X})^{-1} \mathbf{X}_0},$$

with  $s_{n-p}^2$  an estimate to  $\sigma^2$ . At the center of the region of interest for the coded variables the confidence interval is

$$Y_0 \pm t_{\alpha/2, n-p} s_{n-p} \sqrt{C_{11}},$$

with  $C_{11}$  the first diagonal element of  $(\mathbf{X}'\mathbf{X})^{-1}$ . The confidence bound therefore depends on the variance of the response and the quality of the experimental design.

More details can be found in, for example, the text by Myers and Montgomery [6].

#### 6.5.5. Confidence interval on a new evaluation

For multiple regression, the  $100(1-\alpha)\%$  confidence limits on a new evaluation at  $\mathbf{X}_0$  are obtained from

$$Y_0 \pm t_{\alpha/2, n-p} S_{n-p} \sqrt{1 + \mathbf{X}_0 (\mathbf{X}' \mathbf{X})^{-1} \mathbf{X}_0}$$

The confidence interval for new observations of the mean is

$$Y_0 \pm t_{\alpha/2, n-p} S_{n-p} \sqrt{1 + C_{11}}$$

In the following table we monitor the bounds for a new evaluation of the mean for a linear approximation using five design variables using a 95% confidence interval. The value of  $C_{11}$  is computed from D-optimal experimental designs generated using LS-OPT. The error bounds are close to  $2\sigma$  for more than 25 existing runs (20 degrees of freedom).

n	p	n-p	$C_{11}$	Bounds ( $\sigma=10\%$ $\alpha=5\%$ )
10	6	4	0.104	$\pm 29\%$
15	6	9	0.070	$\pm 23\%$
20	6	14	0.051	$\pm 22\%$
25	6	19	0.041	$\pm 21\%$
30	6	24	0.034	$\pm 21\%$
50	6	44	0.020	$\pm 20\%$
100	6	94	0.010	$\pm 20\%$

### 6.5.6. Confidence interval on the noise (stochastic process) variance

The noise (stochastic process) variance can be estimated by considering the residuals of the response surface fit. Events such as a different buckling mode or order of contact events will appear in the residuals because they cannot be attributed to the variables in the response surface fit. These residuals can also be due to a bias (lack-of-fit) error, which complicates matters.

The error of estimating the noise variance ( $\sigma^2$ ) is minimized by:

1. Large number of points
2. Minimizing the bias error. Ideally one wants to observe many occurrences of the same design.

The residual mean square

$$s^2 = \frac{1}{n-p} \sum_{i=1}^n (e_i - \bar{e})^2 = \frac{1}{n-p} \sum_{i=1}^n e_i^2,$$

estimates  $\sigma^2$  with  $n - p$  degrees of freedom where  $n$  is the number of observations and  $p$  is the number of parameters including the mean.

We want to find an interval  $[b_1, b_2]$  such that  $P[b_1 \leq s^2 \leq b_2] = 0.95$ . We rewrite as  $P\left[\frac{n-p}{\sigma^2} b_1 \leq \frac{n-p}{\sigma^2} s^2 \leq \frac{n-p}{\sigma^2} b_2\right] = 0.95$ . We have  $(n-p)s^2/\sigma^2$  is a chi-squared distribution with  $n-p$  degrees of freedom. From the chi-squared table we can get  $[a_1, a_2]$  such that  $P\left[a_1 \leq \frac{n-p}{\sigma^2} s^2 \leq a_2\right] = 0.95$  by reading of the values for 0.975 and 0.025. Having  $[a_1, a_2]$  we can compute for  $[b_1, b_2]$  as  $\left(\frac{s^2}{n-p} a_1, \frac{s^2}{n-p} a_2\right)$ . The  $100(1-\alpha)\%$  confidence interval on  $\sigma^2$  is therefore

$$\left(\frac{(n-p)s^2}{\chi_{\alpha/2, n-p}^2}, \frac{(n-p)s^2}{\chi_{1-\alpha/2, n-p}^2}\right)$$

In the table below we monitor the error bounds on the variance for a problem with six parameters (including the mean).

Noise Variance Confidence Interval								
n	n-p	Lower Bound			Value (s)	Upper Bound		
		$\alpha=5\%$	$\alpha=10\%$	$\alpha=20\%$		$\alpha=20\%$	$\alpha=10\%$	$\alpha=5\%$
10	4	5.99	6.49	7.17	10	19.39	23.72	28.74
15	9	6.88	7.29	7.83	10	14.69	16.45	18.25
20	14	7.32	7.69	8.15	10	13.41	14.60	15.77
25	19	7.605	7.94	8.36	10	12.77	13.70	14.6
30	24	7.81	8.12	8.50	10	12.38	13.16	13.91
50	46	8.31	8.56	8.86	10	11.59	12.10	12.56
106	100	8.78	8.97	9.19	10	11.02	11.33	11.61
206	200	9.11	9.24	9.41	10	10.69	10.92	11.09

In the above it was assumed that the metamodel is a sufficiently accurate approximation to the mechanistic model (the bias error sufficiently small) and that the errors are normally distributed. In general the estimate of  $\sigma^2$  will be depend on the approximation model. For a model-independent estimate, replicate runs (multiple observations for the same design) are required. If the bias error is significant then the estimate of  $\sigma^2$  will usually be too large [7].

### 6.5.7. Probability of observing a specific failure mode

A large number of runs may be required to be sure that an event with a specific probability is observed.

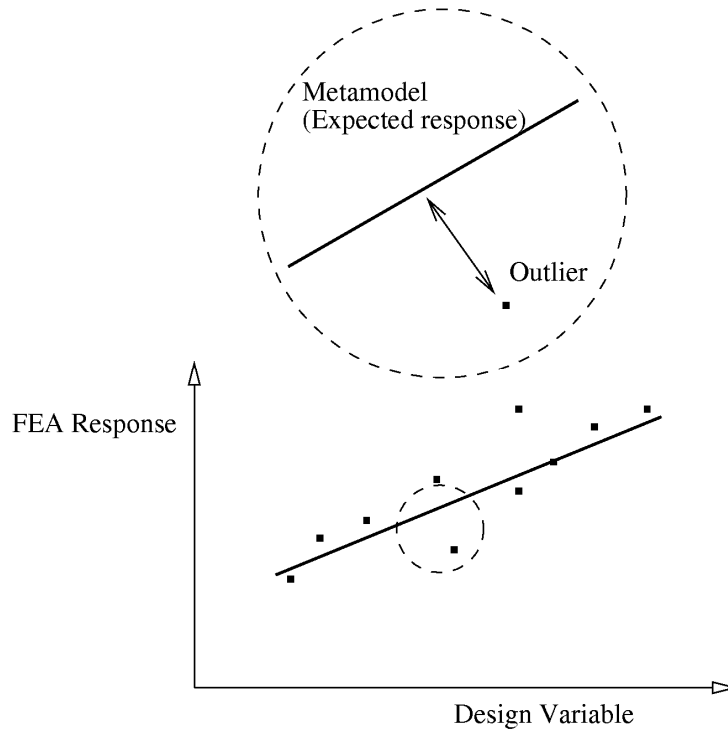
1. Probability that the event will be observed at least once (one or more times):
2.  $P[\text{observing 0 events}] = (1-P[\text{event}])^n$
3.  $P[\text{observing 1 or more events}] = 1.0 - (1-P[\text{event}])^n$

<b>Probability of event</b>	<b>Required number of runs for observing 1 or more occurrences at 95% probability</b>
0.45	5
0.26	10
0.14	20
0.095	30
0.06	50
0.03	100

## 6.6. Outlier analysis

Outliers are values in poor agreement with the values expected or predicted for a specific combination of design variable values. Unexpected values may occur due to different buckling modes or modeling problems. Understanding the cause of the outliers can therefore lead to an improved structure or structural model.

To be considered an outlier, the change in response value computed must not be completely explained by the change in design variable value. An expected value of the response value associated with a certain design is therefore required to judge whether a response is an outlier or not; the value predicted by the metamodel is used as the expected value.



**Figure 6-3** Outliers are identified after a metamodel has been fitted. Values in poor agreement of what is predicted by the design variables are considered outliers.

Metamodels are therefore useful to separate the effect of design variable changes from the other types of variation. The design variable cause-effect relationship is contained by the metamodel. The residuals of the fitting procedure are the variation not explained by changes in the design variables. The outliers therefore contain amongst others the bifurcation (buckling) effects.

The outliers are best investigated visually in LS-PrePost by considering the deformation of the structure. A useful metric is computing the outliers for the displacement of every node in the structure and to fringe plot the standard deviation of these outliers. Fringe plots of the index of the run associated with the maximum or minimum displacement outlier can be used to identify different buckling modes.

## 6.7. Stochastic contribution analysis

The variation of the response can be broken down in contributions from each design variable.

### 6.7.1. Linear estimation

The contribution can be estimated as:

$$\sigma_{g,i} = \partial G / \partial x \sigma_{x,i},$$

with  $\sigma_{x,i}$  the standard deviation of the variable  $i$  and  $\sigma_{g,i}$  the standard deviation of the variation of function  $g$  due to the variation of variable  $i$ .

The variance for all the variables is found as the sum of the variance:

$$\sigma_T^2 = \sum \sigma_i^2$$

where  $\sigma_T^2$  is the variation of the response due to the variation of all the variables and  $\sigma_i^2$  is the variation of response due to the variation of variable  $i$ . In the above it is assumed that the response is a linear response of the design variables and independent variables. If correlation between variables exists, then it is taken into account as documented in section 6.4.3.

### 6.7.2. Second and higher order estimation

For higher order effects, one must consider the interaction between different design variables as well as curvature. If a variation is due to the interaction of two variables, then the effect of one variable on the variation depends on the current value of the other. This is in contrast with problems described by first order effects, for which the effect of variables can be investigated independently; if interactions exist, this is no longer true.

The effect of a variable can be described in terms of its main or total effect. The main effect of a variable is computed as if it were the only variable in the system, while the total effect considers the interaction with other variables as well. The advantage of using the total effect is that the interaction terms, which can be significant, are included. For linear systems, the main and total effects are therefore the same. The second order effects must be computed, which increases computational costs considerably.

The variance of the response, assuming independent variables, can be written using the Sobol's indices approach [8] [9]. Firstly the function is decomposed as:

$$f(x_1, \dots, x_n) = f_0 + \sum_{i=1}^n f_i(x_i) + \sum_{i=1}^n \sum_{j=i+1}^n f_{ij}(x_i, x_j) + \dots + f_{1,2,\dots,n}(x_1, \dots, x_n).$$

From which partial variances are computed as:

$$V_{i,\dots,j} = \int_0^1 \dots \int_0^1 f_{i,\dots,j}^2(x_1, \dots, x_n) dx_i \dots dx_j,$$

with the variance of the response summed from the partial variances as:

$$V = \sum V_i + \sum_{i<j} V_{ij} + \dots + V_{1,2,\dots,n}.$$

The sensitivity indices are given as:

$$\begin{aligned} S_i &= V_i/V, & 1 \leq i \leq n, \\ S_{ij} &= V_{ij}/V, & 1 \leq i < j \leq n, \\ S_{i,i+1,\dots,n} &= V_{i,i+1,\dots,n}/V. \end{aligned}$$

with the useful property that all of the sensitivity indices sum to 1:

$$\sum S_i + \sum_{i < j} S_{ij} + \dots + S_{1,2,\dots,n} = 1.$$

Using Monte Carlo, the main effect can be computed as

$$\hat{D}_i = \frac{1}{N} \sum_{m=1}^N f(x_{\sim i}^{(1)}, x_{\sim i}^{(1)}) f(x_{\sim i}^{(2)}, x_{\sim i}^{(1)}) - \hat{f}_0^2$$

with  $x_{\sim i}$  is the subset of variables not containing  $x_i$ .

The total effect of a variable can also be computed as:

$$S_{Ti} = 1 - S_{\sim i}.$$

Using Monte Carlo, the total effect can be computed by considering the effects not containing  $x_i$

$$\hat{D}_{\sim i} = \frac{1}{N} \sum_{m=1}^N f(\mathbf{x}_{\sim i}^{(1)}, x_{\sim i}^{(1)}) f(\mathbf{x}_{\sim i}^{(1)}, x_{\sim i}^{(2)}) - \hat{f}_0^2.$$

For second order response surfaces this can be computed analytically [10] as

$$\sigma_U^2 = \sum_{i \in U} \left[ \beta_{ii}^2 (m_{i,4} - \sigma_i^4) + (\beta_i + \beta_{ii} \mu_i + \sum_{j=1}^n \beta_{ij} \mu_j)^2 \sigma_i^2 + (\beta_i + \beta_{ii} \mu_i + \sum_{j=1}^n \beta_{ij} \mu_j) \beta_{ii} m_{1,3} \right] + \sum_{i \in U} \sum_{i \in U, j \geq 1} \beta_{ij}^2 \sigma_i^2 \sigma_j^2,$$

with  $m_{i,j}$  the  $j$ th moment about the mean of the distribution  $i$  and  $U$  the set of variables under consideration.

The stochastic contribution is computed analytically only for responses surfaces. For neural networks, Kriging models, and composite functions, two options are currently available:

- *Approximate using second order response surface.* The response surface is built using three times the number of terms in the response surface using a central points Latin hypercube experimental design over a range of plus/minus two standard deviations around the mean.
- *Using a Monte Carlo analysis.* Many points (10,000 or more) are required. This option is used to compute the variance when there is correlation between variables. Note that a small number of points can results in negative values of the variance; these negative values should be small relative to the maximum variances obtained though.



Correlations between variables are not considered in the computation of the main and total effects of the variables.

## 6.8. Robust parameter design

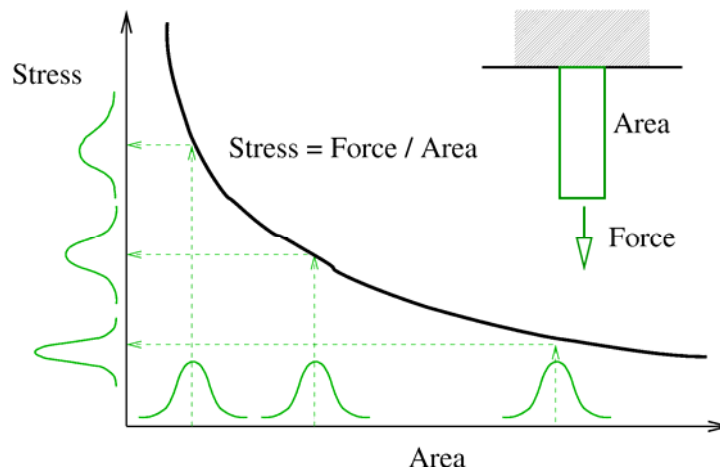
Robust parameter design selects designs insensitive to changes in given parameters.

The field of robust design relies heavily on the work of Taguchi. Taguchi's insight was that it costs more to control the sources of variation than to make the process insensitive to these variations [11]. An alternate view of Taguchi [12] is that building quality into a product is preferable to inspecting for quality. Also, in simulation, the actual results of a robust system are more likely to conform to the anticipated results [11].

The robust design problem definition requires considering two sets of variables: (i) the noise variables causing the variation of the response and (ii) the control variables which are adjusted to minimize the effect of the noise variables. The method adjusts the control variables to find a location in design space with reduced gradients so that variation of the noise variable causes the minimum variation of the responses.

### 6.8.1. Fundamentals

The robustness of a structure depends on the gradient of the response function as shown in Figure 6-4. A flat gradient will transmit little of the variability of the variable to the response, while a steep gradient will amplify the variability of the variable. Robust design is therefore a search for reduced gradients resulting in less variability of the response.

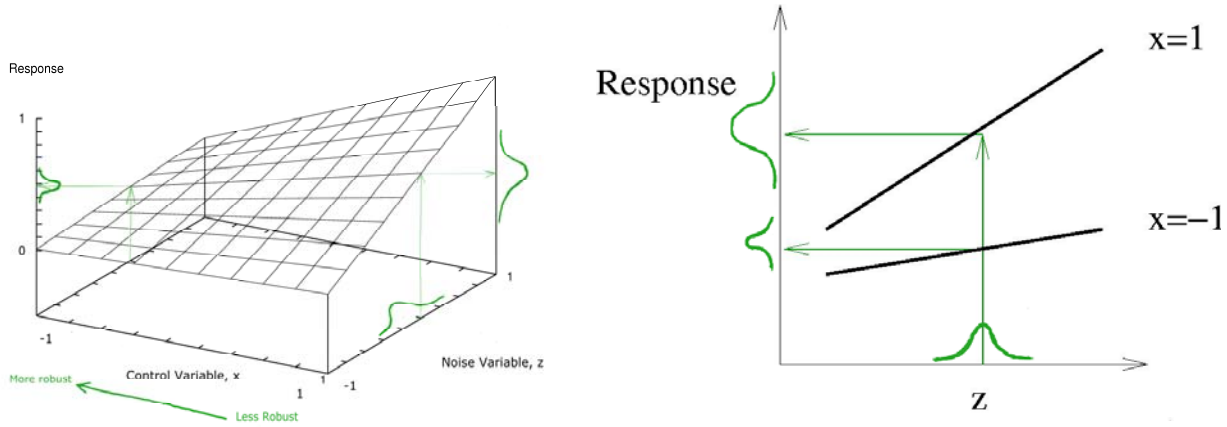


**Figure 6-4 Robustness considering a single variable. Larger mean values of the area result in a smaller dispersion of the stress values. Note that the dispersion of the stress depends on the gradient of the stress-area relationship.**

The variation of the response is caused by a number of variables, some which are not under the control of the designer. The variables are split in two sets of variables:

1. *Control variables.* The variables (design parameters) under the control of the designer are called control variables,
2. *Noise variables.* The parameter not under the control of the designer are called noise variables.

The relationship between the noise and control variables as shown in Figure 6-5 is considered in the selecting of a robust design. The control variables are adjusted to find a design with a low derivative with respect to the noise variable.



**Figure 6-5 Robustness of a problem with both control and noise variables.** The effect of the noise variable  $z$  on the response variation can be constrained using the control variable  $x$ . For robustness, the important property is the gradient of the response with respect to the noise variable. This gradient prescribes the noise in the response and can be controlled using the control variables. The gradient, as shown in the figure, is large for large values of the control variable. Smaller values of the control variable will therefore result in a more robust design, because of the lower gradient and accordingly less scatter in the response.

### 6.8.2. Methodology

The dual response surface method as proposed by Myers and Montgomery [6] using separate models for process mean and variance is considered. Consider the control variables  $\mathbf{x}$  and noise variables  $\mathbf{z}$  with  $Var(\mathbf{z}) = \sigma_z^2 I_{r_z}$ . The response surface for the mean is  $E_z[y(x, z)] = \beta + x' \beta + x' \beta x$  considering that the noise variables have a constant mean. Response surface for variance considering only the variance of the noise variables is  $Var_z[y(x, z)] = \sigma_z^2 l'(x)l(x) + \sigma^2$  with  $Var(\mathbf{z}) = \sigma_z^2 I_{r_z}$ ,  $\sigma^2$  the model error variance, and  $l$  the vector of partial derivatives  $l(x) = \partial y(x, z) / \partial z$ .

The search direction required to find a more robust design is requires the investigation of the interaction terms  $x_i z_j$ . For finding an improved design, the interaction terms are therefore required. Finding the optimum in a large design space or a design space with a lot of curvature requires either an iterative strategy or higher order terms in the response surface.

For robust design, it is required to minimize the variance, but the process mean cannot be ignored. Doing this using the dual response surface approach is much simpler than using the Taguchi approach because multicriteria optimization can be used. Taguchi identified three targets: smaller is better, larger is better, and target is best. Under the Taguchi approach, the process variance and mean is combined into a single objective using a signal-to-noise ratio (SNR). The dual response surface method as used in LS-OPT does not require the use of a SNR objective. Fortunately so, because there is wealth of literature in which SNRs are criticized [6]. With the dual response surface approach both the variance and mean can be used, together or separately, as objective or constraints. Multicriteria optimization can be used to resolve a conflict between process variance and mean as for any other optimization problem.

Visualization is an important part of investigating and increasing robustness. As Myers and Montgomery state : “The more emphasis that is placed on learning about the process, the less important *absolute optimization* becomes.”

### 6.8.3. Experimental design

One extra consideration is required to select an experimental design for robust analysis: provision must be made to study the interaction between the noise and control variables. Finding a more robust design requires that the experimental design considers the  $x_i z_j$  cross-terms, while the  $x_i^2$  and  $z_j^2$  terms can be included for a more accurate computation of the variance.

The crossed arrays of the Taguchi approach are not required in this response surface approach where both the mean value and variance are computed using a single model. Instead combined arrays are used which use a single array considering  $x$  and  $z$  combined.

## 6.9. REFERENCES

- [1] Haldar, A, Mahadevan, S., *Probability, Reliability and Statistical Methods in Engineering Design*, Wiley, Inc. 2000.
- [2] Tu, J., Choi, K.K., Design potential concept for reliability-based design optimization. *Technical report R99-07. Center for Computer Aided Design and Department of Mechanical Engineering.* College of engineering. University of Iowa. December 1999.
- [3] Mendenhall, W., Wackerly, D.D., Scheaffer, R.L., *Mathematical Statistics with Applications*. PWS Kent, Boston, 1990.
- [4] Kokoska, S., Zwillinger, D., *CRC Standard Probability and Statistics Tables and Formulae*, Student Edition. Chapman & Hall/CRC, New York, 2000.
- [5] Box., G.E.P., Draper, N.R., *Empirical Model Building and Response Surfaces*, Wiley, New York, 1987.
- [6] Myers, R.H., Montgomery, D.C., *Response Surface Methodology. Process and Product Optimization using Design Experiments*. Wiley, 1995.
- [7] Draper, N.R., Smith, H., *Applied Regression Analysis*, Second Edition, Wiley, New York, 1981.
- [8] Sobol IM, Sensitivity analysis for nonlinear mathematical models, *Mathematical Modeling and Computer Experiments*, 1(4), pp. 407-413, 1993.

- [9] Chan, K., Saltelli, A., Tarantola, S., Sensitivity analysis of model output: variance-based methods make the difference. *Proceedings of the 1997 Winter Simulation Conference*. 1997, Atlanta, GA.
- [10] Chen, W., Jin, R., Sudjianto, A., Analytical variance-based global sensitivity analysis in simulation-based design under uncertainty. *Proceedings of DETC'04*, Sept 28-October 2, 2004, Salt Lake City, Utah, USA.
- [11] Sanchez, S.M., Robust design: seeking the best of all possible worlds. In *Proceedings of the 2000 Winter Simulation Conference*, ed Joines JA, Barton RR, Kan K, and Fishwick PA. 69-76, Institute of Electrical and Electronic Engineers. Piscataway, NJ.
- [12] Roy RK. *Design of Experiments Using the Taguchi Approach*. Wiley, New York NY. 2001.

# 7. Design Optimization Process

## 7.1. A modus operandi for design using response surfaces

### 7.1.1. Preparation for design

Since the design optimization process is expensive, the designer should avoid discovering major flaws in the model or process at an advanced stage of the design. Therefore the procedure must be carefully planned and the designer needs to be familiar with the model, procedure and design tools well in advance. The following points are considered important:

1. The user should be familiar with and have confidence in the accuracy of the model (e.g., finite element model) used for the design. Without a reliable model, the design would make little or no sense.
2. Select suitable criteria to formulate the design. The responses represented in the criteria must be produced by the analyses and be accessible to LS-OPT.
3. Request the necessary output from the analysis program and set appropriate time intervals for time-dependent output. Avoid unnecessary output as a high rate of output will rapidly deplete the available storage space.
4. Run at least one simulation using LS-OPT (baseline design). To save time, the termination time of the simulation can be reduced substantially. This exercise will test the response extraction commands and various other features. Automated response checking is available, but manual checking is still recommended.
5. Just as in the case of traditional simulation it is advisable to dump restart files for long simulations. LS-OPT will automatically restart a design simulation if a restart file is available. For this purpose, the `runrsf` file is required when using LS-DYNA as solver.
6. Determine suitable design parameters. In the beginning, it is important to select many rather than few design variables. If more than one discipline is involved in the design, some interdisciplinary discussion is required with regard to the choice of design variables.
7. Determine suitable starting values for the design parameters. The starting values are an estimate of the optimum design. These values can be acquired from a present design if it exists. The starting design will form the center point of the first region of interest.
8. Choose a design space. This is represented by absolute bounds on the variables that you have chosen. The responses may also be bounded if previous information of the functional responses is

available. Even a simple approximation of the design response can be useful to determine approximate function bounds for conducting an analysis.

9. Choose a suitable starting design range for the design variables. The range should be neither too small, nor too large. A small design region is conservative but may require many iterations to converge or may not allow convergence of the design at all. It may be too small to capture the variability of the response because of the dominance of noise. It may also be too large, such that a large modeling error is introduced. This is usually less serious as the region of interest is gradually reduced during the optimization process.
10. If the user has trouble deciding the size of the starting range, it should be omitted. In this case the full design space is chosen.
11. Choose a suitable order for the design approximations when using polynomial response surfaces (the default). A good starting approximation is linear because it requires the least number of analyses to construct. However, it is also the least accurate. The choice therefore also depends on the available resources. However, linear experimental designs can be easily augmented to incorporate higher order terms.

Before choosing a metamodel, please also consult Sections 3.3 and 4.5.

After suitable preparation, the optimization process may now be commenced. At this point, the user has to decide whether to use an automated iterative procedure (Section 3.3) or whether to firstly perform variable screening (through ANOVA) based on one or a few iterations. Variable screening is important for reducing the number of design variables, and therefore the overall computational time. Variable screening is illustrated in two examples (see Sections 22.6 and 22.7).

An automated iterative procedure can be conducted with any choice of approximating function. It automatically adjusts the size of the subregion and automatically terminates whenever the stopping criterion is satisfied. The feature that reduces the size of the subregion can also be overridden by the user so that points are sequentially added to the full design space. This becomes necessary if the user wants to explore the design space such as constructing a Pareto Optimal front. If a single optimal point is desired, it is probably the best to use a sequential linear approximation method with domain reduction, especially if there is a large number of design variables. See also Section 4.5.

A step-by-step semi-automated procedure can be just as useful, since it allows the designer to proceed more resourcefully. Computer time can be wasted with iterative methods, especially if handled carelessly. It mostly pays to pause after the first iteration to allow verification of the data and design formulation and inspection of the results, including ANOVA data. In many cases, it takes only 2 to 3 iterations to achieve a reasonably optimal design. An improvement of the design can usually be achieved within one iteration.

A suggested step-by-step semi-automated procedure is outlined as follows:

### 7.1.2. A step-by-step design optimization procedure

1. Evaluate as many points as required to construct a linear approximation. Assess the accuracy of the linear approximation using any of the error parameters. Inspect the main effects by looking at the ANOVA results. This will highlight insignificant variables that may be removed from the problem. An ANOVA is simply a single iteration run, typically using a linear response surface to investigate main and/or interaction effects. The ANOVA results can be viewed in the post-processor (see Section 18.3.4).
2. If the linear approximation is not accurate enough, add enough points to enable the construction of a quadratic approximation. Assess the accuracy of the quadratic approximation. Intermediate steps can be added to assess the accuracy of the interaction and/or elliptic approximations. Radial Basis Functions (Section 3.1.3) can also be used as more flexible higher order functions (They do not require a minimum number of points).
3. If the higher order approximation is not accurate enough, the problem may be twofold:
  - There is significant noise in the design response.
  - There is a *modeling* error, i.e. the function is too nonlinear and the subregion is too large to enable an accurate quadratic approximation.

In case (3a), different approaches can be taken. Firstly, the user should try to identify the source of the noise, e.g. when considering acceleration-related responses, was filtering performed? Are sufficient significant digits available for the response in the extraction database (not a problem when using LS-DYNA since data is extracted from a binary database)? Is mesh adaptivity used correctly? Secondly, if the noise cannot be attributed to a specific numerical source, the process being modeled may be chaotic or random, leading to a noisy response. In this case, the user could implement reliability-based design optimization techniques as described in Section 5.5. Thirdly, other less noisy, but still relevant, design responses could be considered as alternative objective or constraint functions in the formulation of the optimization problem.

In case (3b), the subregion can be made smaller.

In most cases the source of discrepancy cannot be identified, so in either case a further iteration would be required to determine whether the design can be improved.

4. Optimize the approximate subproblem. The solution will be either in the interior or on the boundary of the subregion.

If the approximate solution is in the interior, the solution may be good enough, especially if it is close to the starting point. It is recommended to analyze the optimum design to verify its accuracy. If the accuracy of any of the functions in the current subproblem is poor, another iteration is required with a reduced subregion size.

If the solution is on the boundary of the subregion the desired solution is probably beyond the region. Therefore, if the user wants to explore the design space more fully, a new approximation has to be built. The accuracy of the current response surfaces can be used as an indication of whether to reduce the size of the new region.

The whole procedure can then be repeated for the new subregion and is repeated automatically when selecting a larger number of iterations initially.

## 7.2. Recommended test procedure

A full optimization run can be very costly. It is therefore recommended to proceed with care. Check that the LS-OPT optimization run is set up correctly before commencing to the full run. By far the most of the time should be spent in checking that the optimization runs will yield useful results. A common problem is to not check the robustness of the design so that some of the solver runs are aborted due to unreasonable parameters which may cause distortion of the mesh, interference of parts or undefinable geometry.

The following general procedure is therefore recommended:

1. Test the robustness of the analysis model by running a few (perhaps two or three) designs in the extreme corners of the chosen design space. Run these designs to their full term (in the case of time-dependent analysis). Two important designs are those with all the design variables set at their minimum and maximum values. The starting design can be run by selecting '0' as the number of iterations in the Run panel.
2. Modify the input to define the experimental design for a full analysis.
3. For a time dependent analysis or non-linear analysis, reduce the termination time or load significantly to test the logistics and features of the problem and solution procedure.
4. Execute LS-OPT with the full problem specified and monitor the process.

Also refer to Section 7.1.

## 7.3. Pitfalls in design optimization

A number of pitfalls or potential difficulties with optimization are highlighted here. The perils of using numerical sensitivity analysis have already been discussed and will not be repeated in detail.

### 7.3.1. Global optimality

The Karush-Kuhn-Tucker conditions govern the local optimality of a point. However, there may be more than one optimum in the design space. This is typical of most designs, and even the simplest design problem (such as the well known 10-bar truss sizing problem with 10 design variables), may have more than one optimum. The objective is, of course, to find the global optimum. Many gradient-based as well as discrete optimal design methods have been devised to address global optimality rigorously, but as there is no



mathematical criterion available for global optimality, nothing short of an exhaustive search method can determine whether a design is optimal or not. Most global optimization methods require large numbers of function evaluations (simulations). In LS-OPT, global optimality is treated on the level of the approximate subproblem through a multi-start method originating at all the experimental design points. If the user can afford to run a direct optimization procedure, a Genetic Algorithm (Section 4.8) can be used.

### **7.3.2. Noise**

Although noise may evince the same problems as global optimality, the term refers more to a high frequency, randomly jagged response than an undulating one. This may be largely due to numerical round-off and/or chaotic behavior. Even though the application of analytical or semi-analytical design sensitivities for ‘noisy’ problems is currently an active research subject, suitable gradient-based optimization methods which can be applied to impact and metal-forming problems are not likely to be forthcoming. This is largely because of the continuity requirements of optimization algorithms and the increased expense of the sensitivity analysis. Although fewer function evaluations are required, analytical sensitivity analysis is costly to implement and probably even more costly to parallelize.

### **7.3.3. Non-robust designs**

Because RSM is a global approximation method, the experimental design may contain designs in the remote corners of the region of interest which are prone to failure during simulation (aside from the fact that the designer may not be remotely interested in these designs). An example is the identification of the parameters of a monotonic load curve which in some of the parameter sets proposed by the experimental design may be non-monotonic. This may cause unexpected behavior and possible failure of the simulation process. This is almost always an indication that the design formulation is non-robust. In most cases poor design formulations can be eliminated by providing suitable constraints to the problem and using these to limit future experimental designs to a ‘reasonable’ design space (see Section 2.2.8).

### **7.3.4. Impossible designs**

The set of impossible designs represents a ‘hole’ in the design space. A simple example is a two-bar truss structure with each of the truss members being assigned a length parameter. An impossible design occurs when the design variables are such that the sum of the lengths becomes smaller than the base measurement, and the truss becomes unassemblable. It can also occur if the design space is violated resulting in unreasonable variables such as non-positive sizes of members or angles outside the range of operability. In complex structures it may be difficult to formulate explicit bounds of impossible regions or ‘holes’.

### **7.3.5. Non-unique designs**

In some cases multiple solutions will give the same or similar values for the objective function. The phenomenon often appears in under-defined parameter identification problems. The underlying problem is that of a singular system of equations having more than one solution. The symptoms of non-uniqueness are:

- Different solutions are found having the same objective function values
- The confidence interval for a non-linear regression problem is very large, signaling a singular system

For nonlinear regression problems, the user should ensure that the test/target results are sufficient. It could be that the data set is large but that some of the parameters are insensitive to the functions corresponding to the data. An example is the determination of the Young's modulus ( $E$ ) of a material, but having test points only in the plastic range of deformation (see example Section 22.5). In this case the response functions are insensitive to  $E$  and will show a very high confidence interval for  $E$  (Section 22.5.4).

The difference between a non-robust design and an impossible one is that the non-robust design may show unexpected behavior, causing the run to be aborted, while the impossible design cannot be synthesized at all.

Impossible designs are common in mechanism design.

## 7.4. REFERENCES

- [1] Stander, N. Goel, T. Metamodel sensitivity to sequential sampling strategies in crashworthiness design. In *Proceedings of the 12<sup>th</sup> AIAA/ISSMO Multidisciplinary Analysis and Optimization Conference, Victoria, British Columbia, Canada, Sep 10-12, 2008*.

# 8. Graphical User Interface and Command Language

This chapter introduces the graphical user interface, the command language and describes syntax rules for names of variables, strings and expressions.

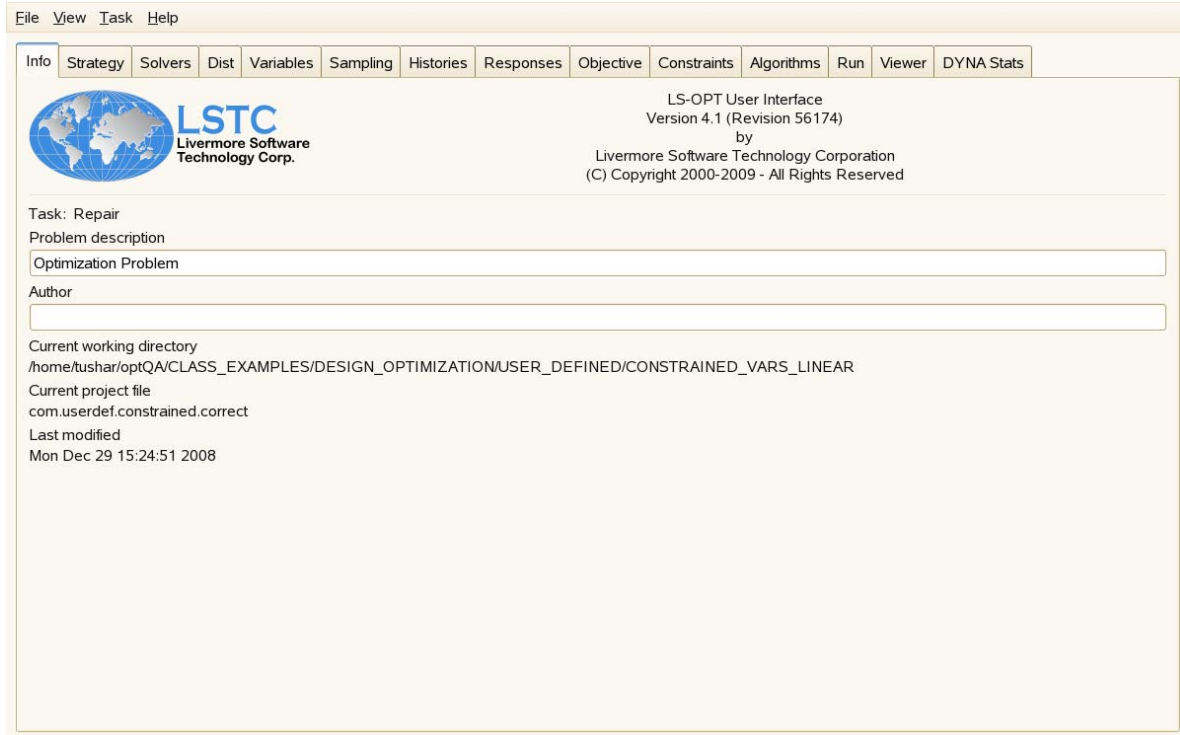
## 8.1. LS-OPT user interface (LS-OPTui)

LS-OPT can be operated in one of two modes. The first is through a graphical user interface, LS-OPT*ui*, and the second through the command line using the Design Command Language (DCL).

The user interface is launched with the command

```
lsoptui [command_file]
```

The layout of the menu structure (Figure 8-1) mimics the optimization setup process, starting from the problem description, through the selection of design variables and experimental design, the definition and responses, and finally the formulation of the optimization problem (objectives and constraints). The run information (number of processors, monitoring and termination criteria) is also controlled via LS-OPT*ui*.



*Figure 8-1: Information panel in LS-OPTui*

## 8.2. Problem description and author name

In LS-OPTui, the Info (main) panel has fields for the entering of the problem description and author information.

### Command file syntax

---

```
problem_description
author author_name
```

---

A description of the problem can be given in double quotes. This description is echoed in the `lsopt_input` and `lsopt_output` files and in the plot file titles.

#### *Example:*

```
"Frontal Impact"
author "Jim Brown"
```

The number of variables and constraints are echoed from the graphical user input. These can be modified by the user in the command file.

### Command file syntax:

---

```
solvers number_of_solvers < 1 >
constants number_of_constants < 0 >
variables number_of_variables
dependents number_of_dependent_variables < 0 >
histories number_of_response_histories < 0 >
responses number_of_responses
composites number_of_composites < 0 >
objectives number_of_objectives < 0 >
constraints number_of_constraints < 0 >
distributions number_of_distributions < 0 >
```

---

*Example:*

```
variable 2
constraint 1
responses 2
objectives 2
```

The most important data commands are the definitions. These serve to define the various entities which constitute the design problem namely solvers, variables, results, matrices, responses, objectives, constraints and composites. The definition commands are:

---

```
solver package_name
constant name value
variable name value
dependent name value
result name string
history name string
matrix name string
response name string
composite name type type
composite name string
objective name entity weight
constraint name entity name
```

---

Each definition identifies the entity with a name. “Results” and “matrices” do not require a count. Other entities will be phased out in future.

### 8.3. Command language

The command input file is a sequence of text commands describing the design optimization process. It is also written automatically by LS-OPT*ui*.

The Design Command Language (DCL) is used as a medium for defining the input to the design process. This language is based on approximately 200 command phrases drawing on a vocabulary of about 200 words. Names can be used to describe the various design entities. The command input file combines a sequence of text commands describing the design optimization process. The command syntax is not case sensitive.

### 8.3.1. Names

Entities such as variables, responses, etc. are identified by their names. The following entities must be given unique names:

```
solver
constant
variable
dependent
result
history
matrix
response
composite
objective
constraint
```

A name is specified in single quotes, e.g.

```
solver dyna 'DYNA_side_impact'
constant 'Young_modulus' 50000.0
variable 'Delta' 1.5
dependent 'new_modulus' {Young_modulus + Delta}
result 'x_acc' "BinoutResponse -res_type rcforc -cmp z_force -id 1
               -side SLAVE -select TIME -end_time 0.002"
Matrix 'strain' {Matrix3x3Init(0.001,0.002,0.0035, a,b,c, d,e,f)}
History 'y_vel' "DynaASCII nodout Y VEL 187705 TIMESTEP 0 SAE 30"
Response 'x_acc' "DynaASCII rbdout X ACC 21 AVE"
composite 'deformation' type targeted
composite 'sqdef' {sqrt(deformation)}
objective 'deformation' composite 'deformation' 1.0
constraint 'Mass' response 'Mass'
```

In addition to numbers 0-9, upper or lower case letters, a name can contain any of the following characters:

`_`. The leading character must be alphabetical. *Spaces are not allowed.* A name length is limited to 61 characters.

Note:

Because mathematical expressions can be constructed using various entities in the same formula, duplication of names is not allowed.

### 8.3.2. Command lines

Preprocessor commands, solver commands or response extraction commands are enclosed in double quotes, e.g.,

```
$ SPECIFICATION OF PREPROCESSOR AND SOLVER
preprocessor command "/usr/ls-dyna/ingrid"
solver command "/alpha6_2/usr/ls-dyna/bin/ls-dyna_9402_dec_40"
$ IDENTIFICATION OF THE RESPONSE
response 'displacement' "DynaRelativeDisp 0.2"
response 'Force' "Myforce"
```

In addition to numbers 0-9, upper or lower case letters and spaces, a command line can contain any of the following characters:

```
_ = - . ' / < > ; `
```

In the command input file, a line starting with the character \$ is ignored. A command must be specified on a single line.

### 8.3.3. File names

Input file names for the solver and preprocessor must be specified in double quotes.

```
prepro input file "p11i"
solver input file "side_impact"
```

### 8.3.4. Command file structure

The commands are arranged in two categories:

problem data

solution tasks

There are several commands for specifying the available tasks. The remaining commands are for the specification of problem data. A solution task command serves to execute a solver or processor while the other commands store the design data in memory.

In the following chapters, the command descriptions can be easily found by looking for the large typescript bounded by horizontal lines. Otherwise the reader may refer to the quick reference manual that also serves as an index. The default values are given in angular brackets, e.g. < 1 >.

### 8.3.5. Environments

Environments have been defined to represent all dependent entities that follow. The only environments in LS-OPT are for

- o solver *identifier\_name*

All responses, response histories, solver variables, solver experiments and solver-related job information defined within this environment are associated with the particular solver.

- strict, slack/soft Pertains to the strictness of constraints. See Sections 16.5.
- move, stay Pertains to whether constraints should be used to define a reasonable design space or not for the experimental design. See Section 13.8.

### 8.3.6. Expressions

Each entity can be defined as a standard formula, a mathematical expression or can be computed with a user-supplied program that reads the values of known entities. The bullets below indicate which options apply to the various entities. Variables are initialized as specified numbers.

*Table 8-1: Expression options of optimization entities*

Entity	Standard	Expression	User-defined
Variable			
Dependent		●	
Result	●	●	●
Matrix		●	
History	●	●	●
Response	●	●	●
Composite	●	●	

A list of mathematical and special function expressions that may be used is given in Appendix D : Mathematical Expressions.



# 9. Program Execution

This chapter describes the directory structure, output and status files, and logistical handling of a simulation-based optimization run.

## 9.1. Work directory

Create a work directory to keep the main command file, input files and other command files as well as the LS-OPT program output.

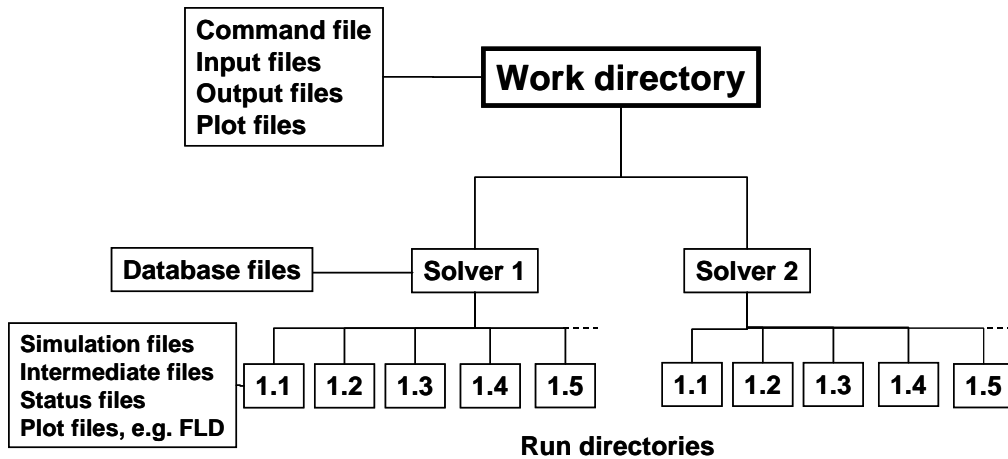
## 9.2. Execution commands

<code>lsoptui <i>command_file_name</i></code>	Execute the graphical user interface
<code>lsopt <i>command_file_name</i></code>	LS-OPT batch execution
<code>lsopt info</code>	Create a log file for licensing
<code>lsopt env</code>	Check the LS-OPT environment setting
<code>viewer <i>command_file_name</i></code>	Execute the graphical postprocessor

The LS-OPT environment is automatically set to the location of the `lsopt` executable.

## 9.3. Directory structure

When conducting an analysis in which response evaluations are done for each of the design points, a sub-directory will automatically be created for each analysis.



**Figure 9-1 : Directory structure in LS-OPT**

These sub-directories are named `solver_name/mmm.nnnn`, where `mmm` represents the iteration number and `nnnn` is a number starting from 1. `solver_name` represents the solver interface specified with the command, e.g.

```
solver dyna 'side_impact'
```

In this case `dyna` is a reserved package name and `side_impact` is the name of an analysis case chosen by the user. The work directory needs to contain at least the command file and the template input files. Various other files may be required such as a command file for a preprocessor. An example of a sub-directory name, defined by LS-OPT, is `side_impact/3.11`, where `3.11` represents the design point number of iteration 3. The creation of subdirectories is automated and the user only needs to deal with the working directory.

In the case of simulation runs being conducted on remote nodes, a replica of the run directory is automatically created on the remote machine. The `response.n` and `history.n` files will automatically be transferred back to the local run directory at the end of the simulation run. These are the only files required by LS-OPT for further processing.

## 9.4. Job monitoring

The job status is automatically reported at a regular interval. The user can also specify the interval. The interface, LS-OPTui reports the progress of the jobs in the Run panel (see Section 17.8). The text screen output while running both the batch and the graphical version also reports the status as follows:

JobID	Status	PID	Remaining
-----	-----	-----	-----
1	N o r m a l termination!		
2	Running	8427 00:01:38	(91% complete)
3	Running	8428 00:01:16	(93% complete)

```
4 Running          8429 00:00:21 (97% complete)
5 Running          8430 00:01:13 (93% complete)
6 Running          8452 00:21:59 (0% complete)
7 Waiting ...
8 Waiting ...
```

In the batch version, the user may also type control-C to get the following response:

```
Jobs started
Got control C. Trying to pause scheduler ...
Enter the type of sense switch:
sw1: Terminate all running jobs
sw2: Get a current job status report for all jobs
t: Set the report interval
v: Toggle the reporting status level to verbose
stop: Suspend all jobs
cont: Continue all jobs
c: Continue the program without taking any action
Program will resume in 15 seconds if you do not enter a choice switch:
```

If `v` is selected, more detailed information of the jobs is provided, namely event time, time step, internal energy, ratio of total to internal energy, kinetic energy and total velocity.

## 9.5. Result extraction

Each simulation run is immediately followed by a result extraction to create the `history.n` and `response.n` files for that particular design point. For distributed simulation runs, this extraction process is executed on the remote machine. The `history.n` and `response.n` files are subsequently transferred to the local run directory.

## 9.6. Restarting

Restarting is conducted by giving the command:

```
lsopt command_file_name, or by selecting the Run button in the Run panel of LS-OPTui.
```

Completed simulation runs will be ignored, while half completed runs will be restarted automatically. However, the user must ensure that an appropriate restart file is dumped by the solver by specifying its name and dump frequency.

The following procedure must be followed when restarting a design run:

1. As a general rule, the run directory structure should not be erased. The reason is that on restart, LS-OPT will determine the status of progress made during a previous run from status and output files in the directories. Important data such as response values (`response.n` files), response histories (`history.n` files) are kept only in the run directories and is not available elsewhere.

2. In most cases, after a failed run, the optimization run can be restarted as if starting from the beginning. There are a few notable exceptions:
  - A single iteration has been carried out but the design formulation is incorrect and must be changed.
  - Incorrect data was extracted, e.g., for the wrong node or in the wrong direction.
  - The user wants to change the response surface type, but keep the original experimental design.

In the above cases, all the history.n and response.n files must be deleted. After restarting, the data will then be newly extracted and the subsequent phases will be executed. A restart will only be able to retain the data of the first iteration if more than one iteration was completed. The directories of the other higher iterations must be deleted in their entirety. Unless the database was deleted (by, e.g., using the clean file, see Section 9.9), no simulations will be unnecessarily repeated, and the simulation run should continue normally.

3. A restart can be made from any particular iteration by selecting the ‘Specify Starting Iteration’ button on the Run panel, and entering the iteration number. The subdirectories representing this iteration and all higher-numbered iterations will be deleted after selecting the Run button and confirming the selection.
4. The number of points can be changed for a restart (see Section 13.14).

## 9.7. Output files

The following files are intermediate database files containing ASCII data.

*Table 9-1: Intermediate ASCII database files*

Database file	Description	Directory
Experiments_n.csv	Trial designs computed as a result of the experimental design	Case
AnalysisResults_n.lsox	.xml file containing all the extracted results including responses, matrices and histories.	Case
AnalysisResults_n.csv	The same trial designs and the responses extracted from the solver database	Case
DesignFunctions	Parameters of the approximate functions	Case
VirtualHistoryFunction	Approximation functions data for histories	Main
OptimizationHistory	Variable, response and error history of the successive approximation process	Main
OptimizerHistory	Detailed history of the optimizer	Main
ExtendedResults	All variables, responses and extended results at each trial design point	Case

<code>Net.funcname</code>	Parameters of the metamodel of function with name <i>funcname</i>	Case
<code>Variables.n</code>	The variable values, confidence intervals and bounds	Main

A more detailed description of the database is available in **Appendix C**.

The output files are as follows:

**Table 9-2: Output files**

Database file	Description	Directory	View option
<code>lsopt_input</code>	Input in a formatted style	Work	Input
<code>lsopt_output</code>	Results and some logging information. Usually a very large file.	Work	Output
<code>lsopt_report</code>	A final report of the analysis results. Available for some of the main tasks and most of the Repair tasks	Work	Summary
<code>lsopt_db</code>	This file communicates the current status of the LSOPT databases to other LSTC programs. The content of this file is subject to change between versions of LS-OPT.	Work	File
<code>lsopt_results_n.binout*</code>	All variable, responses and extended results of the non-dominated solutions at each iteration	Work	

\*This binary file is equivalent to the TradeOff.\* files in the older versions.

The following files are in a .csv (comma separated variables) format:

**Table 9-3: Result files in .csv format**

Database file	Description	Directory	Remarks
<code>Experiments_n.csv</code>	Experiments ( $n$ = iteration number)	Case	

AnalysisResults_ <i>n</i> .csv	Analysis Results	Case	
ExtendedResultsMaster_ <i>n</i> .csv	Extended Results (variables, dependents, responses, composites, objectives, constraints, multiobjective)	Case	
ExtendedResultsMETAMaster_ <i>n</i> .csv	Extended Results file for user-defined Experiments file	Case	See Section 0
PRESS_predictions_ <i>n</i> .csv	PRESS (Section 2.3.4) predicted results and PRESS residuals (Polynomials and Radial Basis Function networks (Section 3.1.2) only. PRESS residuals are not computed for Feedforward Neural Networks)	Case	Use check box to select PRESS in Viewer→ Accuracy→
OptimizerHistory_ <i>n</i> .csv	Detailed history of the optimizer for iteration <i>n</i>	Work	

## 9.8. Log files and status files

Status files `prepro`, `replace`, `started`, `finished`, `history.n`, `response.n` and `EXIT_STATUS` are placed in the run directories to indicate the status of the solution progress. The directories can be cleaned to free disk space but selected status files must remain intact to ensure that a restart can be executed if necessary.

A brief explanation is given below.

**Table 9-4: Status files generated by LS-OPT**

<code>prepro</code>	The preprocessing has been done.
<code>replace</code>	The variables have been replaced in the input files.
<code>started</code>	The run has been started.
<code>finished</code>	The run has been completed. The completion status is given in the file.
<code>response.n</code>	Response number <i>n</i> has been extracted.
<code>history.n</code>	History number <i>n</i> has been extracted.
<code>EXIT_STATUS</code>	Error message after termination.

- The user interface `LS-OPTui` uses the message in the `EXIT_STATUS` file as a pop-up message.
- The `lfop.log` file contains a log of the core optimization solver solution.

- The simulation run/extraction log is saved in a file called `lognnnnnn` in the local run directory, where `nnnnnn` represents the process ID number of the run. An example of a logfile name is `log234771`.

Please refer to Section 9.6 for restarting an optimization run.

## 9.9. Managing disk space during run time

During a successive approximation procedure, superfluous data can be erased after each run while keeping all the necessary data and status files (see above and example below). For this purpose the user can provide a file named `clean` containing the required erase statements such as:

```
rm -rf d3*
rm -rf elout
rm -rf nodout
rm -rf rcforc
```

The `clean` file will be executed immediately after each simulation and will clean all the run directories except the baseline (first or 1.1) and the optimum (last) runs. Care should be taken not to delete the lowest level directories or the log files `prepro`, `started`, `replace`, `finished`, `response.n` or `history.n` (which must remain in the lowest level directories). These directories and log files indicate different levels of completion status which are essential for effective restarting. Each file `response.response_number` contains the extracted value for the response: `response_number`. E.g., the file `response.2` contains the extracted value of response 2. The essential data is thus preserved even if all solver data files are deleted. The `response_number` starts from 0.

Complete histories are similarly kept in `history.history_number`.

The minimal list to ensure proper restarting is:

```
prepro
XPoint
replace
started
finished
response.0
response.1
.
.
history.0
history.1
.
.
```

**Remarks:**

1. The `clean` file must be created in the work directory.
2. If the `clean` file is absent, all data will be kept for all the iterations.
3. For remote simulations, the `clean` file will be executed on the remote machine.

**9.10. Error termination of a solver run**

The job scheduler will mark an error-terminated job to avoid termination of LS-OPT. Results of abnormally terminated jobs are ignored. If there are not enough results to construct the approximate design surfaces, LS-OPT will terminate with an appropriate error message.

**9.11. Parallel processing**

Runs can be executed simultaneously. The user has to specify how many processors are available.

**Command file syntax:**

---

```
solver concurrent jobs number_of_jobs
```

---

If a parallel solver is used, the number of concurrent jobs used for the solution will be *number\_of\_jobs* times the number of `cpu`'s specified for the solver.

**Example:**

```
solver concurrent jobs 16
```

If the number of concurrent jobs is specified as 0, all the jobs will be run simultaneously. This can be used to transfer all the jobs to a queuing system (see Section 9.12) at once.

**9.12. Remote job scheduling**

The solver jobs do not have to be executed on the same machine as where LS-OPT is running. There are several ways of distributing the solver jobs. An example of remote job distribution is when the user is running LS-OPT on a laptop or desktop computer but prefers to run multiple solver jobs in parallel on a computer cluster.

There are five common scenarios that we try to address using various LS-OPT job scheduling options.

1. `runqueuer/wrapper` option
  - a. You have a *queueing system* and you want to submit some or all LS-OPT solver jobs to that queueing system.
  - b. You can allow remote solver jobs to initiate TCP/IP connections back to the machine where LS-OPT runs.



2. blackbox option
  - a. You have a queueing system and you want to submit some or all LS-OPT solver jobs to that queueing system.
  - b. You prefer not to allow remote solver jobs to initiate TCP/IP connections back to the machine where LS-OPT runs.
3. lstcvm option
  - a. You do not have a queueing system. You would like to run LS-OPT on one machine, but you would like to run all solver jobs on a single, dedicated cluster.
  - b. You can share a file system between LS-OPT and the cluster where the solver jobs are run.
4. lstcvm/runqueueer/wrapper option
  - a. You do not have a queueing system. You would like to run LS-OPT on one machine, but you would like to run all solver jobs on a single, dedicated cluster.
  - b. You prefer not to share a file system between LS-OPT and the cluster where the solver jobs are run.
  - c. You do allow remote solver jobs on the dedicated cluster to connect via TCP/IP back to the machine where LS-OPT is running.
5. lstcvm/blackbox option
  - a. You have a queueing system that you would like to use for job submission, but the machine where you would like to run LS-OPT does not have a command line submit utility for the queueing system.
  - b. There is a machine on your system where
    - i. You can install the `lstcvm` job proxy server;
    - ii. You can submit jobs using a command line utility;
    - iii. You can share a file system with the machine where LS-OPT will run;

## 9.13. Using an external queuing or job scheduling system

### 9.13.1. Introduction

The LS-OPT Queuing Interface interfaces with load sharing facilities (e.g. LSF<sup>1</sup> or LoadLeveler<sup>2</sup>) to enable running simulation jobs across a network. LS-OPT will automatically copy the simulation input files to each remote node, extract the results on the remote directory and transfer the extracted results to the local directory. The interface allows the progress of each simulation run to be monitored via `LS-OPTui`. The `README.queue` file should be consulted for the most up to date information about the queuing interface.

---

<sup>1</sup> Registered Trademark of Platform Computing Inc.

<sup>2</sup> Registered Trademark of International Business Machines Corporation

**Command file syntax:**


---

```
Solver queue [queue_name]
```

---

**Table 9-5: Queuing options**

queuer_name	Description
lsf	LSF
loadleveler	LoadLeveler
pbs	PBS <sup>3</sup>
nqe	NQE <sup>4</sup>
nqs	NQS <sup>5</sup>
ags	AQS
slurm	SLURM
user	User Defined
blackbox	Black box
mscpp	MS Windows Compute Cluster Server
honda	dedicated queuer

**9.13.2. Installation**

To run LS-OPT with a queuing (load-sharing) facility the following binary files are provided in the LSOPT\_EXE directory which un-tars (or unzips) from the distribution during installation of LS-OPT:

```
LSOPT_EXE/wrapper
LSOPT_EXE/runqueuer
```

The runqueuer executes the command line for the purpose of queuing and must remain in the LS-OPT environment (the same directory as the lsopt executable).

The following instructions should then be followed:

***Installation for all remote machines running LS-DYNA***

1. Create a directory on the remote machine for keeping all the executables including lsdyna. Copy the appropriate executable wrapper program to the new directory. e.g. if you are running LS-

---

<sup>3</sup> Portable Batch System. Registered Trademark of Veridian Systems

<sup>4</sup> Network Queuing Environment. Registered Trademark of Cray Inc.

<sup>5</sup> Network Queuing System

DYNA on a Linux machine, place the wrapper appropriate for the architecture and operating system on this machine.

### *Installation on the local machine*

2. Select the queuer option in LS-OPTui or add a statement in the LS-OPT command file to identify the queuing system, e.g.

```
solver queuer loadleveler
```

for each solver. 0.

To pass all the jobs to the queuing system at once, select zero concurrent jobs in the GUI or command file, e.g.

```
solver concurrent jobs 0
```

*Example:*

```
solver command "rundyna.hp DynaOpt.inp single 980"
solver input file "car6_crash.k"
solver queuer loadleveler
```

In this example, the arguments to the rundyna.hp script are optional and can be hard-coded in the script.

1. Change the script you use to run the solver via the queuing facility by prepending "wrapper" to the solver execution command. Use full path names for both the wrapper and executable or make sure the path on the remote machine includes the directory where the executables are kept.

The argument for the input deck specified in the script must always be the LS-OPT reserved name for the chosen solver, e.g. for LS-DYNA use `DynaOpt.inp`.

### **9.13.3. Examples**

*Example 1:* This example uses a two-level script. The outer script (`submit_pbs`) sets the values of environment variables in `dynscr` (the inner script), spawns it and submits it through the queuing system. The script `dynscr` then sets the environment variables and schedules the solver on the remote machine.

The LS-OPT command file part relating to the queue is:

```
solver dyna960 'Case1'
$ ---- PBS Script
  solver command "/nec00a/mike/project/submit_pbs"
$ ---- Input file with variable substitution
  solver input file "input.k"
$ ---- Queuing specification
  solver queue pbs
```

The "submit\_pbs" file is:

```
#!/bin/csh -f
#
# Run jobs on a remote processor, remote disk
set newdir=`pwd | sed -n 's/.*\\/(.*)\\/(.*)/\\1\\/\\2/p'`
# Run jobs on a remote processor, local disk (no transmission)
# set newdir=`pwd`
echo $newdir
cat > dynscr << EOF
#
# dynscr script
# =====
#!/bin/csh -f
#
#PBS -l nodes=1:ncpus=1
#
setenv LSOPT /nec00a/mike/codes/LSOPT_EXE
setenv LSOPT_HOST $LSOPT_HOST
setenv LSOPT_PORT $LSOPT_PORT
# Run jobs on a remote processor, remote disk
mkdir -p lsopt/$newdir
cd lsopt/$newdir
# The input file name is required for LS-OPT
/nec00a/mike/codes/wrapper /nec00a/mike/codes/ls980.single i=DynaOpt.inp
EOF
# ===== E N D   O F   S C R I P T =====
qsub dynscr
```

Example 2:

This example demonstrates how to specify the queuer command directly on the command line. It shows how the required environment variables LSOPT\_PORT and LSOPT\_HOST set by the runqueuer program are specified on the solver command line whereas the two user variables LSDYNA971\_MPP and LSOPT\_WRAPPER are defined and stored as special input entities (see Section 9.15). These can also be set on the command line using the Linux "setenv" command as specified in for instance the .cshrc script. qsub is a PBS queue submit command and the -v directive defines the names of environment variables to be exported to the job.

The qsub manual pages should be consulted for more details. Please also consult Sections 9.13.5 (Environment Variables) and 9.15 (Passing Environment Variables through LS-OPT).

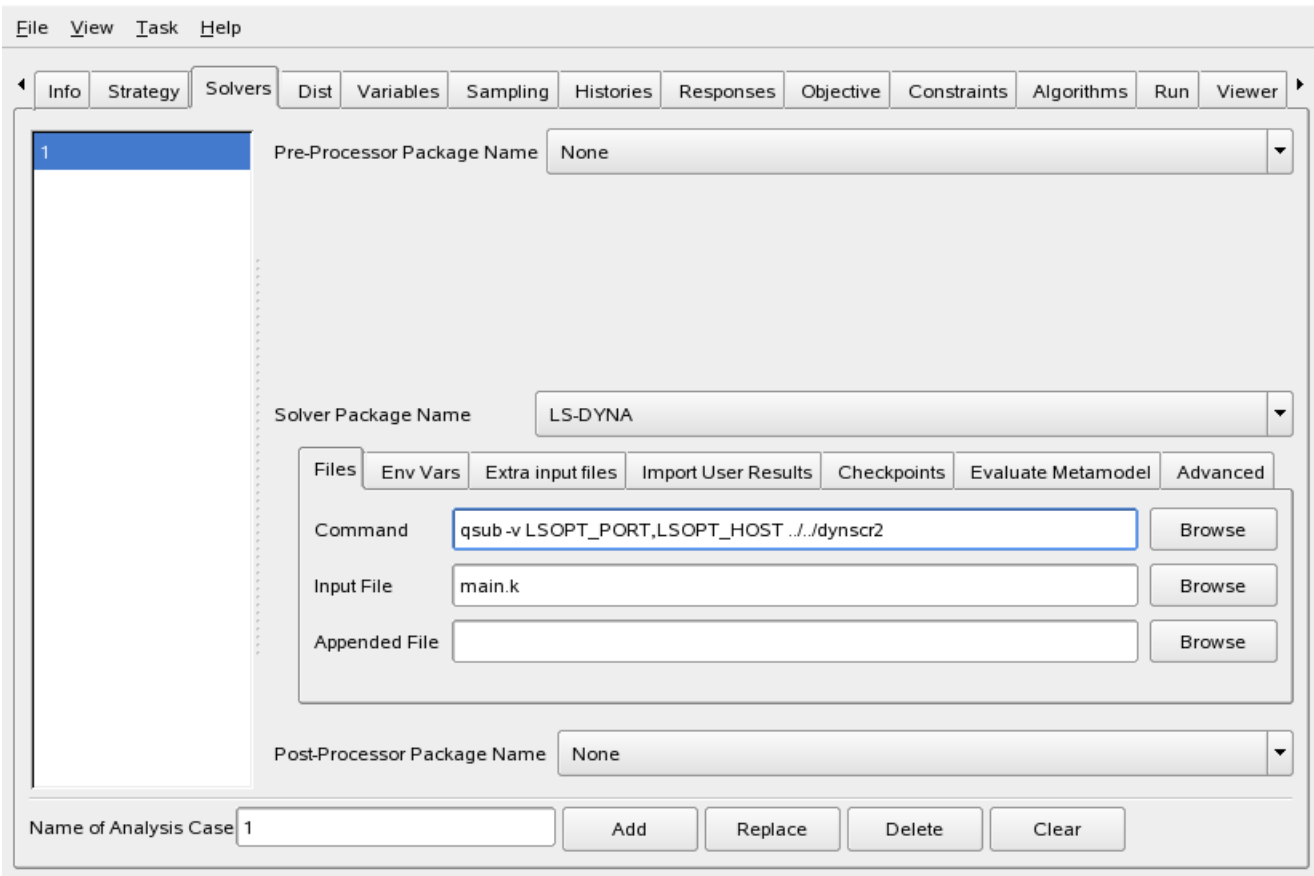
```
solver dyna960 '1'
  solver command "qsub -v LSOPT_PORT,LSOPT_HOST ../../dynscr2"
  solver envvar 'LSDYNA971_MPP' "/florida_1/john/bin/mpp_ls971_single"
  solver envvar 'LSOPT_WRAPPER' "/florida_1/john/LSOPT_EXE/wrapper"
  solver input file "main.k"
```

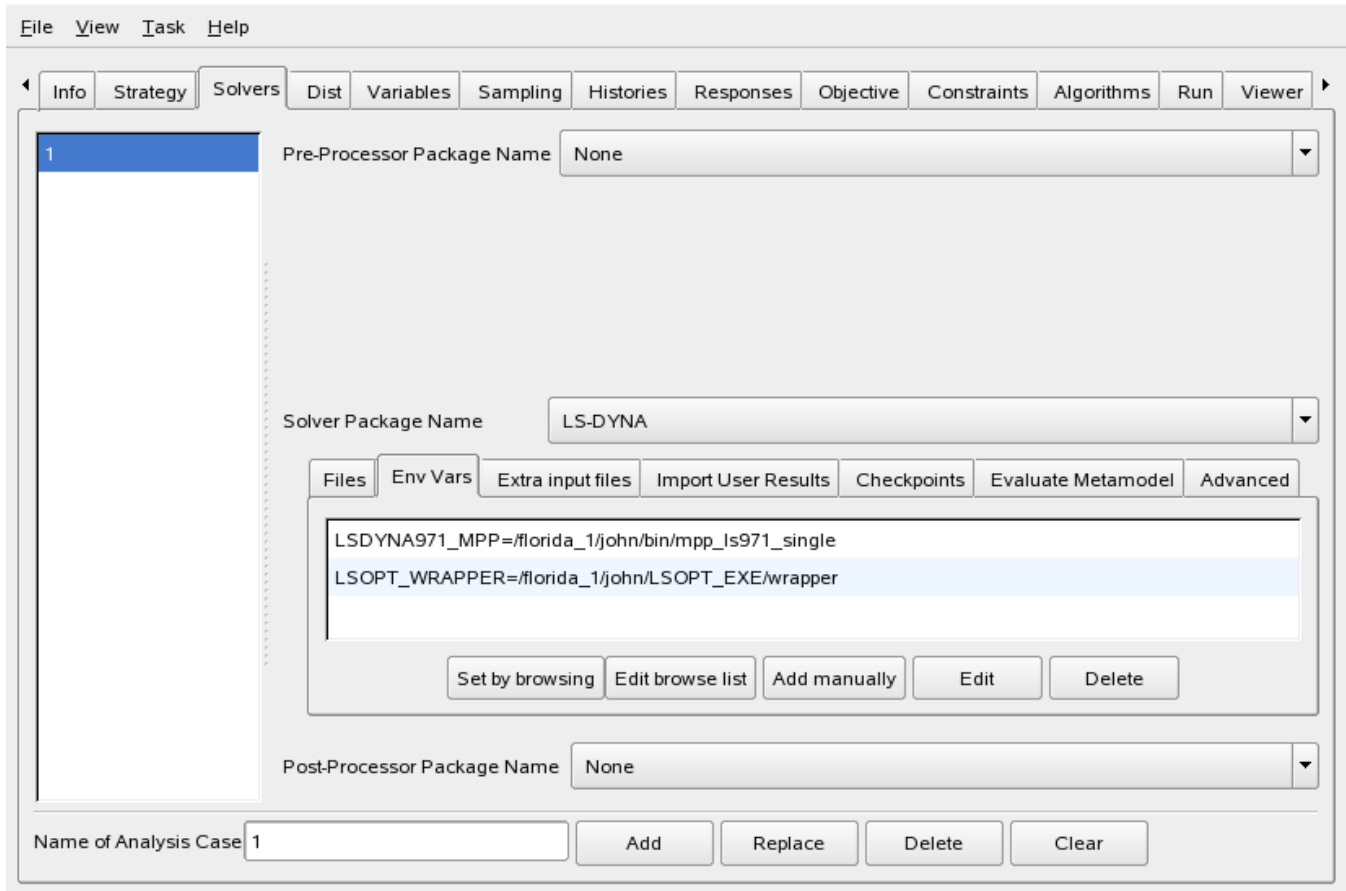
The dynscr2 file in this case is:

```
# This is the dynscr2 file
```

```
#####  
#!/bin/csh -f  
#  
#$ -cwd -pe mpi 2  
#  
setenv NP 2  
setenv ROUNDROBIN 0  
#  
# Define LSDYNA971_MPP environment variables in lsopt input  
# or shell command ("setenv").  
# $1 represents i=DynaOpt.inp and is automatically  
# tagged on as the last argument of the lsopt "solver command".  
#  
setenv EXE "$LSDYNA971_MPP $1"  
#  
rm -f mpd.hostfile mpp.appfile  
filter_hostfile < $PE_HOSTFILE > mpd.hostfile  
#  
# This python script builds an HPMPI specific "appfile" telling it  
# exactly what to run on each node.  
#  
gen_appfile.hpmpi mpd.hostfile $SGE_O_WORKDIR $NP $ROUNDROBIN $EXE > mpp.appfile  
#  
# This actually executes the job  
#  
$LSOPT_WRAPPER /opt/hpmpi/bin/mpirun -f mpp.appfile  
#
```

The solver command data and environment variable input are displayed below.





### 9.13.4. Mechanics of the queuing process

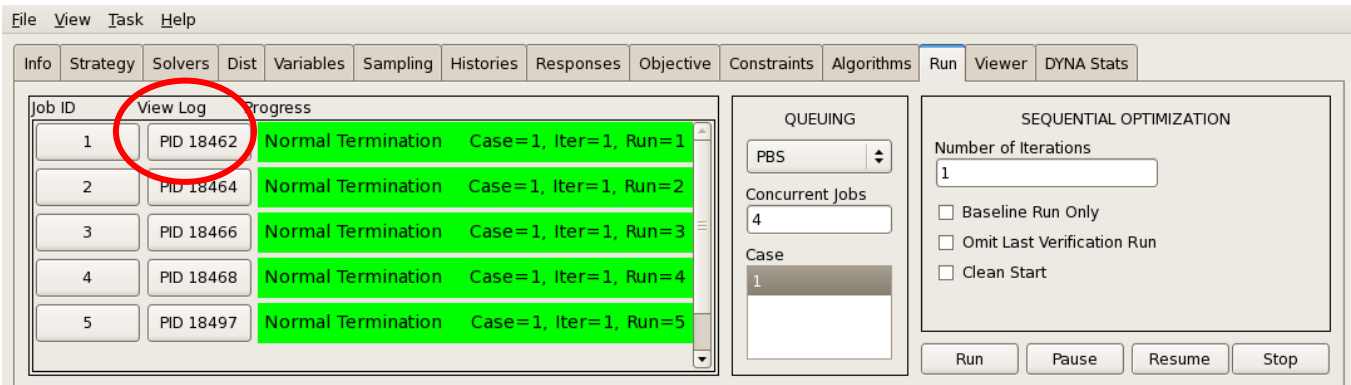
Understanding the mechanics of the queuing process should help to debug the installation:

1. LS-OPT automatically prepends `runqueuer` to the solver command and executes `runqueuer` which runs the `submit_pbs` script.
  - The `runqueuer` sets the variables `LSOPT_HOST` and `LSOPT_PORT` locally.
  - In the first example, the `submit_pbs` script spawns the `dynscr` script.
2. In Example 1, the queuing system then submits `dynscr` (see `qsub` command at the end of the `submit_pbs` script above) on the remote node which now has fixed values substituted for `LSOPT_HOST` and `LSOPT_PORT`.

In Example 2, LS-OPT schedules the `qsub` command directly with `LSOPT_HOST` and `LSOPT_PORT` as arguments and `i=DynaOpt.inp` appended at the end of the command. `i=DynaOpt.inp` therefore serves as an argument (`$1`) to `dynscr2`.

3. The wrapper executes on the same machine as LS-DYNA, opens a socket and connects back to the local host using the host/port information. The standard output is then relayed to the local machine. This output is also written to the `logxxxx` file (where `xxxx` is the process number) on the local

host. To view the log of any particular run, the user can select a button on the **Run** page under the *View Log* heading. The progress dialog is shown below, followed by the selected popup log.



```

-----
JOB 1 INFORMATION
-----
JOB TYPE: LS-DYNA
DIRECTORY: 1/1.1
PID: 18462
STATUS: FINISHED
LOGFILE: 1/1.1/log18462

-----
CONTENTS OF LOGFILE 1/1.1/log18462
-----
[STDOUT] STARTING command /florida_1/nielen/LSOPT_EXE/runqueuer
Wrapper listening on PORT=44378
[STDOUT] PORT=44378
Wrapper reports QUEUER='PBS'
Looking for PBS Job pattern: N.SERVER
[STDOUT] JOB=PBS
[STDOUT] Your job 8277 ("submit_pbs") has been submitted
Wrapper reports connection from remote job on PORT=52411
[STDOUT] CONNECTION_PORT=52411
[STDOUT] *****
[STDOUT] LS-OPT Wrapper
[STDOUT] LS-OPT Revision Number : 57186
[STDOUT] *****
[STDOUT] Get Extraction Databases
[STDOUT] Finished Get Extraction Databases
[STDOUT] Read Extraction Database
[STDOUT] solver.db read begin
[STDOUT]
[STDOUT] Solver database read
[STDOUT]
[STDOUT] History data read
-----
Dismiss

```

An example of an error message resulting from a mistype of “wrapper” in the submit script is given in another example log file as follows:

```

STARTING command /home/jim/bin/runqueuer
PORT=56984
JOB=LoadLeveler
llsubmit: The job "1/1.1" has been submitted.

```



```

/home/jim/LSOPT_EXE/Xrapper: Command not found.
Finished with directory
/home/jim/LSOPT/4.1/optQA/QUEUE/EX4a_remote/remote/1/1.1

```

4. The wrapper will also extract the data immediately upon completion on the remote node. Extracted data (the `history.n` and `response.n` files) are automatically transferred back to the local sub-directory. If other parts of the database (e.g. `d3plot` files) are required (e.g. for post-processing with LS-PREPOST), the user has to specify these in the command file using appropriate LS-OPT commands (see Section 9.13.9). A log of the database extraction is also provided in the `logxxxx` file.

### 9.13.5. Environment variables

Users typically do not set these. These variables are set on the local side by the `runqueueer` program and their values must be carried to the remote side by the queuing software.

`LSOPT_HOST` : the machine where LS-OPT (and therefore the `runqueueer`) is running. Set this if the wrapper has trouble connecting back to `runqueueer`.

`LSOPT_PORT` : TCP/IP port `runqueueer` listens on for remote connections

The `runqueueer` program does not set `LSOPT_HOST` if it is already set, but *always* sets `LSOPT_PORT`. The examples in Section 9.13.3 illustrate two methods by which setting of environment variables can be accomplished. Environment variables specified by "solver envvar" settings (see Section 9.15) are set by the scheduler. The scheduler runs `runqueueer`, and `runqueueer` would be the one to run

```
qsub -v LSOPT_PORT,LSOPT_HOST script_name
```

So, the `LSOPT_PORT` value passed to the remote side will always be the one set by `runqueueer`. However, the `LSOPT_HOST` value may be set through "solver envvar" or though ".cshrc" instead.

In most cases the queuing system will transmit the environment variables to the remote side, so the setting of the variables may not be necessary. The only reason to set `LSOPT_HOST` would be to compensate for a wrong setting. For example, the machine where LS-OPT is running may be known by several different host names or by different IP addresses. In such as case it might be required to specify which interface should be used for remote connections. It is not permissible for `LSOPT_PORT` to be changed because *only* the `runqueueer` knows the right setting.

### 9.13.6. Abnormal termination and retrying the job submission

#### *User-defined abnormal termination*

It may be prudent to retry job submissions for certain types of abnormal termination. For this purpose, the user can specify an `Abnormal` signal for terminations which are neither normal nor error termination. A job that has terminated in this way can then be retried by the LS-OPT job scheduler. The `Abnormal` signal should be sent to standard output from the simulation script. The following two parameters can be used to set the number of retries allowed and timeout for each retry. The defaults are shown in square brackets

**Command file syntax:**


---

```
Solver job retry [number_of_retries_allowed[9]]
Solver job timeout [timeout_for_retry_in_seconds[60]]
```

---

***Queuer timeout***

A special case exists in which the LS-OPT job scheduler automatically generates an `A b n o r m a l` signal. This is whenever the wrapper has not been executed for a specified timeout period. For this case a queuer timeout can be specified.

**Command file syntax:**


---

```
Solver queue timeout [number_of_minutes[720]]
```

---

The queuer timeout is the time it will wait for the wrapper to connect, otherwise it sets an abnormal termination status and writes an `A b n o r m a l` signal to standard output. In this case the job will be resubmitted for the number of retries specified and using the queuing timeout for each retry.

**9.13.7. Troubleshooting**

1. Diagnostics for a failed run usually appear in the `logxxxx` file in the run directory. If there is almost no information in this file, the wrapper path may be wrong or the submission script may have the wrong path or permission. For any job, this file can be viewed from the progress dialog on the **Run** page.  
Please attach the log file (`lsopt_output`) when emailing [support@lstc.com](mailto:support@lstc.com).
2. Make sure that the permissions are set for the executables and submission script.
3. Check all paths to executables e.g. "wrapper", etc. No diagnostic can detect this problem.
4. Make sure that the result database is produced in the same directory as where the wrapper is started, otherwise the data cannot be extracted. (E.g. the front end program such as `mpirun` may have a specification to change the working directory (`-wd dir`)).
5. *Running on a remote disk.* Make sure that the file "HostDirectory" is not copied by a user script to the remote disk if the simulation run is done on a remote disk. The "HostDirectory" file is a marker file which is present only on the local disk. Its purpose is to inform the wrapper that it is running on the local disk and, if found on a remote disk, will prevent the wrapper from automatically transferring extracted results back to the local disk. In general the user is not required to do any file copying since input files (including LS-DYNA include files) are copied to the remote disk automatically. The `response.*` and `history.*` files are recovered from the remote disk automatically. Other files can be recovered using the feature in Section 9.14 .
6. *Termination of user-defined programs:* LS-DYNA always displays a 'N o r m a l' at the end of its output. When running a user-defined program which does not have this command displayed for a normal termination, the program has to be executed from a script followed by a command to write

'N o r m a l' to standard output. The example file *runscript* shown below first runs the user-defined solver and then signals a normal termination.

```
mpiexec -n 2 /home/john/bin/myprogram -i UserOpt.inp
# print normal termination signal to screen
echo 'N o r m a l'
```

which is submitted by the wrapper command in `submit_pbs` as:

```
/home/john/bin/wrapper /home/john/bin/runscript
```

*Note:* Adding "echo N o r m a l" at the end of the wrapper command (after a semicolon) does not work which is why it should be part of the script run by the wrapper.

### 9.13.8. User-defined queuing systems

To ensure that the LS-OPT job scheduler can terminate queued jobs, two requirements must be satisfied:

1. The queuer must echo a string

```
Job "Stringa Stringb Stringc ..." has been submitted
```

or

```
Job Stringa has been submitted
```

e.g.

```
Job "Opteron Aqs4832" has been submitted
```

```
Job aqs4832 has been submitted
```

The string will be parsed as separate arguments in the former example or as a single argument in the latter example. The string length is limited to 1024 characters. The syntax of the phrases "Job " and "has been submitted" must be exactly as specified. If more than one argument is specified without the double quotes, the string will not be recognized and the termination feature will fail.

2. A termination script (or program) `LsoptJobDel` must be placed either in the main working directory (first default location) or in the directory containing the LS-OPT binaries (second default). This script will be run with the arguments *stringA*, *stringB*, etc. and must contain the command for terminating the queue. An example of a Unix C shell termination script that uses two arguments is:

```
#!/bin/csh -f
aadmin -c $1 -j $2 stop
```

### 9.13.9. Blackbox queuing system

The Blackbox queuing system is another flavor of the User-defined queuing system. It can be used when the computers running the jobs are separated from the computer running LS-OPT by means of a firewall. The key differences between User-defined and Blackbox are:

1. It is the responsibility of the queuing system or the user provided scripts to transfer input and output files for the solver between the queuing system and the workstation running LS-OPT. LS-OPT will

not attempt to open any communications channel between the compute node and the LS-OPT workstation.

2. Extraction of responses and histories takes place on the local workstation instead of on the computer running the job.
3. LS-OPT will not run local placeholder processes (i.e. extractor/runqueueer) for every submitted job. This makes Blackbox use less system resources, especially when many jobs are run in each iteration.

When using the Blackbox queuing system, a `LsoptJobDel` script is required, just as in the User-defined case. Furthermore, another script named `LsoptJobCheck` must also be provided. This script takes one parameter, the job ID, as returned by the submission script. The script should return the status of the given job as a string to standard output.

The Blackbox queuer option requires the user to specify a command that will queue the job. For example,

```
solver ls971_single '1'  
solver command ".././submit_script"  
...  
solver queue blackbox
```

The Blackbox option can also be specified in the "Run" panel of the LS-OPT user interface.

In this case, the solver is named `ls971_single` and the case subdirectory is named '1'. The command to queue the job (in this case `submit_script`) must return a *job identifier* that has one of the following two forms:

```
Job "Any Quoted String" has been submitted  
Job AnyUnquotedStringWithoutSpaces has been submitted
```

The Word "Job" must be the first non-white space on the line, and must appear exactly as shown. Any amount of white space may appear between "Job" and the job identifier, as well as after the job identifier and before "has been submitted".

The Blackbox queuer requires the presence of two executable scripts `LsoptJobCheck` and `LsoptJobDel`. These scripts must be located in either in the current LS-OPT project directory or in the directory where the running LS-OPT program is located. (For Windows, the scripts must have an added extension `.exe`, `.vbs`, `.cmd` or `.bat`). If the Blackbox queuer option is invoked for some solver, then LS-OPT checks for the existence of executable scripts in one of these locations, and refuses to run if the `LsoptJobCheck` and/or `LsoptJobDel` scripts cannot be found or are not executable. The project directory is searched first.

## LsoptJobCheck script

The user-supplied `LsoptJobCheck` script is run each time LS-OPT tries to update the current status of a job. The `LsoptJobCheck` script is run with a single commandline argument:

```
LsoptJobCheck job_identifier
```

The working directory of the `LsoptJobCheck` script is set to the job directory associated with `job_identifier`.

The script is expected to print a status statement that LS-OPT can use to update its status information. The only valid status statements are:

String	Description
WAITING	The job has been submitted and is waiting to start
RUNNING	The job is running.
RUNNING <i>N/M</i>	After RUNNING, the script may also report the progress as a fraction. RUNNING 75/100 means that the job has ¼ to go. The progress information will be relayed to the user, but not used in any other way by LS-OPT.
FAILED	The job failed. This is only to be used when the underlying queueing system reports some kind of problem. Hence, a solver that has terminated in error does not have to be detected by the <code>LsoptJobCheck</code> script.
FINISHED	The job has completed and any output files needed for extraction has been copied back to the run directory.
ABORTED	If a job reports ABORTED, then the status bar on the Run page of LSOPTui turns yellow, and the number of retries is shown.

Any amount of white space may appear at the beginning of a status statement, and anything may appear after these statements. The optional *N/M* argument for RUNNING is interpreted as an estimate of the progress; in this case *N* and *M* are integers and *N/M* is the fractional progress. *N* must be not be larger than *M*.

If `LsoptJobCheck` terminates without printing a valid status statement, then it is assumed that `LsoptJobCheck` does not function properly, and LS-OPT terminates the job using the `LsoptJobDel` script. All output from the `LsoptJobCheck` script is logged to the job log file (`logxxxx`) in the run directory for debugging purposes.

*Note:* The `LsoptJobCheck` script may print more than one status statement, but only the first one will be used to update the status.

## LsoptJobDel script

The user-supplied `LsoptJobDel` script is run whenever the user chooses to terminate a job, or whenever LS-OPT determines that a job should be killed (for example, if `LsoptJobCheck` fails). The `LsoptJobDel` script is run with a single commandline argument:

```
LsoptJobDel job_identifier .
```

The working directory of the `LsoptJobDel` script is set to the job directory associated with `job_identifier`.

### 9.13.10. Honda queuing system

The Honda queuing system interface is based on the Blackbox queuing system, but is dedicated to the particular needs of this system.

#### Mechanics of the Honda queuing process

The queuing system generates a status file for which an environment variable has been defined in LS-OPT as:

```
$HONDA_STATUSFILE
```

The status file is the output of the PBS queue check command. During the initialization phase, LS-OPT checks whether this variable setting points to a valid file. If it does not, LS-OPT terminates before starting the scheduler, and prints a standard LSOPT-style error message.

The line which marks the fields in the status file is used to determine how to parse the file; this line has the form "`----- - ----- ....`". Fields are extracted based on this line which consists solely of space and dash characters. The following fields are used:

4	name
6	status: 'R' for running or 'Q' for queued
10	total wall clock time allowed
11	total wall clock time consumed.

Fields 10 and 11 are used to set the progress indicator. If the indicator ever reaches 100%, then it will terminate due to total wall clock time restrictions.

If a job cannot be found in the status file, then it is assumed to be dead. The job status entry is not looked for until a minimum of 3 seconds after the job has been started. A status file is searched for a particular job status entry only if the status file has a modification time that is later than the start time of the job.

Since there is no way to determine the exit status of a job by looking only at this status file, the determination of the final exit status depends on whether or not the job is an LS-DYNA job. If the job is an LS-DYNA job, then the messag file is parsed for the status statements "N o r m a l" and "E r r o r" termination. If no messag file is found *10 seconds* after the job is no longer listed in the status file, then we assume an error termination.

If the job is a non-LS-DYNA job, then LsoptJobCheck (see Section 9.13.9) is executed just once after the job no longer appears in the status file. LsoptJobCheck should print either (a) FINISHED or (b) ERROR in order to communicate the final exit status. If LsoptJobCheck cannot be found or cannot be executed, then ERROR is assumed. The job log file will contain a message indicating any problem that may exist which prevents LsoptJobCheck from being run.

The HONDA queued jobs do not use LsoptJobDel as defined in the Blackbox queuing selection. Jobs are deleted using the standard PBSPro qdel command.

Various statements concerning how status information is gathered are logged to the job log files. These are:

1. Job status for LSDYNA jobs found in 'messag' file:

```
[HONDA] Termination status found in 'messag' file
[HONDA] exact termination statement
```

2. The job status line for the current job found in \$HONDA\_STATUSFILE is saved:

```
[HONDA] status line
```

3. The job is assumed finished if there is no status line found:

```
[HONDA] Job 23551 not found in STATUS file - assuming job is finished.
```

4. Indication that LsoptJobCheck is run at the end of a non-LS-DYNA job:

```
[HONDA] Non LS-DYNA job. Running LsoptJobCheck to determine exit status.
```

5. Status returned from LsoptJobCheck.

```
[HONDA] Job finished - LsoptJobCheck reports normal termination
[HONDA] Job finished - LsoptJobCheck reports error termination
```

Any errors while gathering status information are logged to the job log files such as log12345.

6. Missing messag file after LSDYNA terminates:

```
[HONDA] Failed to find 'messag' file while FINISHING.
[HONDA] Assuming ERROR termination for LSDYNA job.
```

7. Found no termination status statement in messag file

```
[HONDA] Found no termination status in 'messag' file
[HONDA] Assuming ERROR termination for LSDYNA job.
```

8. HONDA\_STATUSFILE variable not set

```
[HONDA] *** Error $HONDA_STATUSFILE not set.
```

#### 9. Could not open \$HONDA\_STATUSFILE

```
[HONDA] *** Error Failed to open $HONDA_STATUSFILE=pbsq_status
```

#### 10. LsoptJobCheck script not found for non-LSDYNA job

```
[HONDA] *** Error LsoptJobCheck cannot be found.
[HONDA]     Assuming error termination for non-LSDYNA job.
```

#### 11. LsoptJobCheck script did not print either (a) FINISHED or (b) FAILED.

```
[HONDA] *** Error LsoptJobCheck did not return a valid status.
[HONDA]     Assuming error termination for non-LSDYNA job.
```

If \$HONDA\_STATUSFILE is not updated in a timely fashion, then the scheduler can hang forever, never moving forward. A message is passed to lsopt through the communication socket if this happens:

```
*** Warning HONDA_STATUSFILE out of date by more than 5 minutes
*** Job progress monitoring suspended until next update
```

Even though the status file is checked before starting the scheduler, it is still possible for file errors to occur. These are also sent directly to LS-OPT.

```
*** Error $HONDA_STATUSFILE not set
*** Error Failed to open $HONDA_STATUSFILE=pbsq_status
```

### 9.13.11. Microsoft Windows Compute Cluster server

LS-OPT supports submission of jobs to the Microsoft Compute Cluster Pack Scheduler. Two scripts called `submit.cmd` and `submit.vbs`, that work together, are available to interface LS-OPT with CCP. The script can be downloaded from `ftp://ftp.lstc.com/ls-opt/QUEUING/MSCCS`. Before using the scripts the variables in the beginning of the file `submit.cmd` needs to be changed to fit your local environment. Most users do not need to change the `submit.vbs` file.

The example shows how the queue-related parts of an LS-OPT command file look when using the CCP scripts, when they are placed in the same directory as the command file:

#### Example:

```
solver dyna960 '1'
  solver command "..\..\submit.cmd \\fileserver\bin\ls971.exe"
  solver input file "key.k"
  solver queue msccp
```



## 9.14. Enabling LSTCVM job proxy support

### 9.14.1. LSTCVM options

There are two ways that LS-OPT can work with the LSTCVM job proxy.

1. *LSTCVM and LS-OPT share a common file system.* If LSTCVM and LS-OPT share a common file system, then you may run LS-OPT jobs from within the shared file system by using the solver command

```
lstcvm_run remote_solver_command
```

For example

```
solver command "lstcvm_run ls971_single"
```

would be the appropriate solver command in LS-OPT if you want to run the "ls971\_single" command on the remote LSTCVM server.

2. *LSTCVM and LS-OPT do not share a common file system.* In this case, you may still execute remote commands on the LSTCVM server, but you must select the following option in the Advanced GUI tab for the Solver: **Use LSTCVM proxy**. LS-OPT will take care of prepending the `lstcvm_run` command. So, in this case, if you want to execute "ls971\_single" on the remote LSTCVM server, then your solver command should simply be

```
solver command "ls971_single"
```

All necessary input files will be transferred to the remote LSTCVM server using LS-OPT `runqueuer/wrapper` commands. Extraction results are automatically brought back to the local side once the job has finished.

*Note:* In order for this option to work, you must install the LS-OPT "wrapper" on the LSTCVM proxy server, and you must add the following entry to the executable map file "lstcvm.exemap"

```
wrapper -> full_path_to_wrapper
```

The "wrapper" command is architecture specific. So be sure to obtain the correct program for the LSTCVM architecture.

REMOTE FILES: We do not currently delete files on the LSTCVM server after the job has completed. This must be done by the LSTCVM proxy server administrator.

### 9.14.2. LSTCVM server installation

The LSTCVM server is distributed separately from LS-OPT and, in addition to the executables, contains detailed information and installation instructions. This server installation is usually handled by a systems administrator.

### 9.14.3. Environment Variables

All solver environment variables defined in the LS-OPT **EnvVar** tab of the Solver are automatically passed to the remote job on the LSTCVM server. (PATH is not passed for security reasons). This provides a convenient way to define licensing variables for LS-DYNA. For example, you can pass the following variables to the remote proxy server job:

```
LSTC_LICENSE=network
```

```
LSTC_LICENSE_SERVER=license_server_name
```

### 9.14.4. Configuring the `lstcvm_run` client

The `lstcvm_run` client should be supplied with the LS-OPT distribution. If you do not have such a command in the LS-OPT installation directory, then your version of LS-OPT is probably not LSTCVM ready. We suggest obtaining a later version of LS-OPT in that case.

In order to configure the "`lstcvm_run`" client, you should execute

```
lstcvm_run -s lstcvm_server_name
```

The information will be saved so that this step never needs to be repeated. If you are running on a Microsoft Windows platform, then you should execute this command from within a command prompt; the server information will be saved in the Windows registry. If you are running on a Linux/UNIX platform, then the server information is stored in `$HOME/.lstcvm`. If, for some reason, a port other than the default is used, then you must specify the port number `N` with the command

```
lstcvm_run -s N@lstcvm_server_name
```

After setting the server name, then you can test for connectivity using

```
lstcvm_run -info
```

You should see information about the current configuration of the LSTCVM server.

To test the installation, 'cd' to a directory where you are allowed to run the `lstcvm_run` client, and issue the command

```
lstcvm_run ls -al
```

It is possible that this command will fail if the LSTCVM administrator does not allow the "`ls`" command to be run. If that is the case, then check with the administrator about which commands are available.

Once you know that the `lstcvm_run` command is properly configured and able to execute commands remotely, then you are ready to use `lstcvm_run` with LS-OPT. Only commands which are allowed and enabled by the LSTCVM administrator will function properly. For example, `ls971_single` is not available unless the remote administrator has enabled this command.

### 9.14.5. Database recovery

When distributing the simulation runs, the data can be recovered to the local machine. There are two commands: a LS-DYNA specific command and a general command.

**LS-DYNA:****Command file syntax:**


---

```
Solver recover dyna [d3plot|d3hsp|binout|d3eigv|eigout]
```

---

The LS-DYNA database can be recovered by using the above command. The requested database file will appear in the local directory. Each name is a prefix, so that e.g. `d3plot01`, `d3plot02`, ... will be recovered when specifying `d3plot`. The details of the recovery procedure is logged in a local directory file.

*Example:*

```
Solver recover dyna d3plot
Solver recover dyna binout
```

The recovery of the LS-DYNA database is only required if the user wants to do local post-processing (e.g. using LS-PREPOST). Otherwise the results are automatically extracted and transferred to the local node in the form of files `response.n` and/or `history.n`.

**User-defined :****Command file syntax:**


---

```
Solver recover file "[file_wildcard]"
```

---

Any database can be recovered by using the above command. The requested database file will appear in the local directory. Each name is a wildcard.

*Example:*

```
Solver recover file "d3plot*"
Solver recover file "*"
```

- The first command will recover the full `d3plot` database.
- The last command will recover all the files from the run directory on the remote node to the run directory on the local node, hence the local directory will mirror the remote directory.
- A log of the database recovery is available in the `logxxxx` file in the run directory on the local machine.

**9.14.6. Simple manual setup for running LS-OPT and solvers on different machines**

A convenient setup is one in which LS-OPT runs on e.g. a Windows machine and the solvers are running on a cluster (typically Linux). Such a setup can be created as follows:

1. Install LS-OPT on a Windows (or any desired) machine for preparing the input. Create the problem setup using LS-OPTui. The `solver` command should be created for running jobs on a cluster. This can be done by selecting any of the queuing systems supported by LS-OPT or, if all the jobs will be running on the same cluster where LS-OPT resides, simply by specifying the solver executable name as a *solver command*. The number of concurrent jobs should be set for each case on the **Run** page. Save the input to a file using e.g. the name `com`.
2. Open the `com` file with LS-OPTui and create a second command file e.g. `com.pack` by selecting **Tools**→**Gather LS-OPT database + histories/responses** and saving as `com.pack`. There are now two command files: `com` for running the optimization task and `com.pack` for packing the output data after the run.
3. Install LS-OPT and the solver executables on a cluster node for running LS-OPT in batch mode. Copy the recently created problem setup with the two command files from the Windows machine onto a cluster node. This setup should allow the user to run an LS-OPT job in batch mode.
4. Run LS-OPT by executing the command: `lsopt com` on the cluster. This is done from the command line.
5. After completion of the LS-OPT run, execute `lsopt com.pack` to create a file `lso_pack_h.tar.gz` containing the entire run database.
6. Unzip `lso_pack_h.tar.gz` on the Windows machine to do the post-processing.

## 9.15. Passing environment variables through LS-OPT

LSOPT provides a way to define environment variables that will be set before executing a solver command. The desired environment variable settings can be specified directly in the `com` file with solver commands:

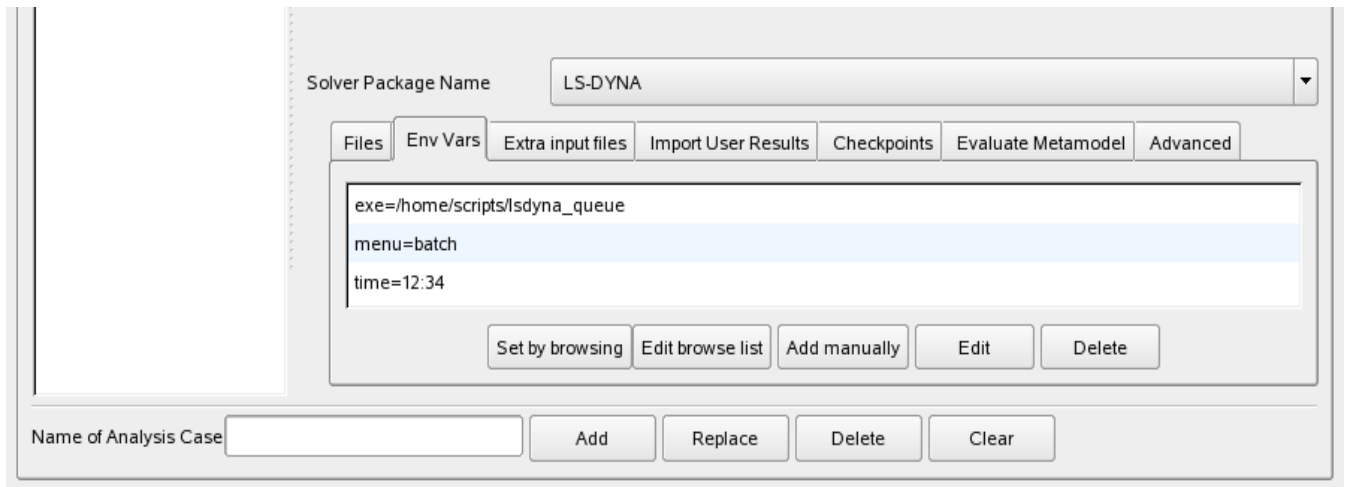
### Command file syntax:

---

```
Solver envvar 'varname' "varvalue"
```

---

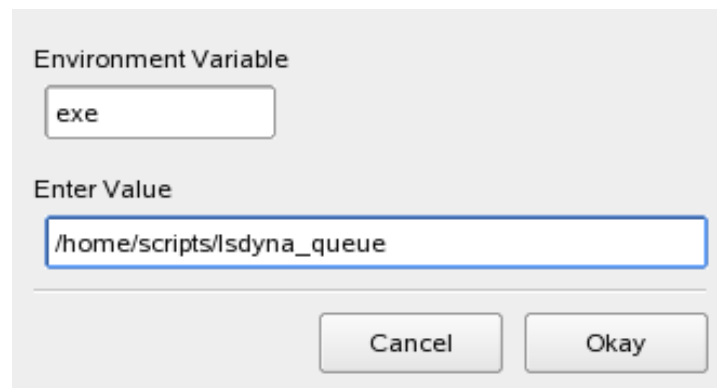
Or they can be specified in the GUI within the **Env Vars** tab under **Solvers**.



Passing environment variables to solver commands can be a convenient way to control the behavior of a solver command. For example, the solver command might be a script which queues a job on a remote machine; the environment variable settings might be used by the script to select various queuing options. Or, the environment variable settings might be passed along through the queuing system to set options for the remotely executed job, such as license server locations, input file names, whether to run the MPP version of LS-DYNA, whether to run a single or double precision solver, etc.

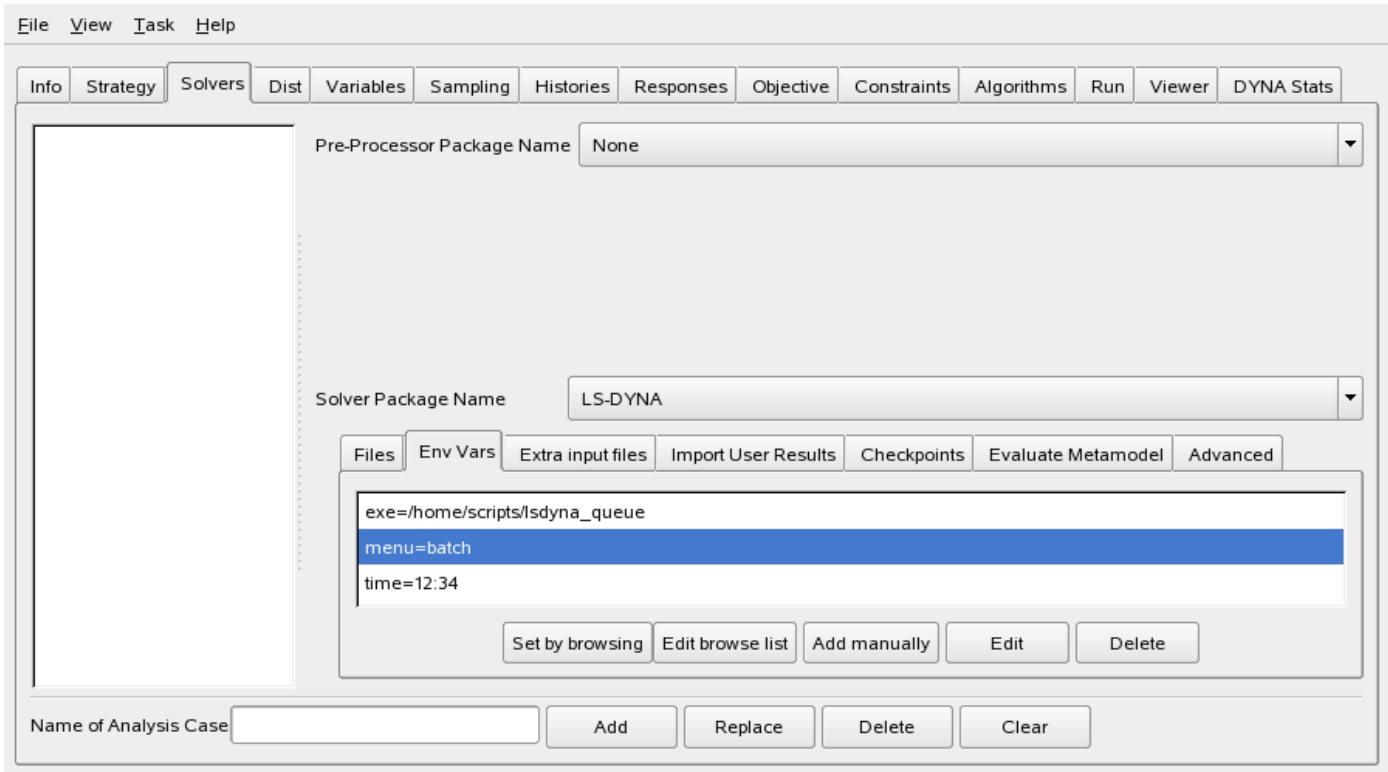
### 9.15.1. Adding a new environment variable definition

Select the button **Add manually** to define a single environment variable. After selecting this option, a dialog will appear where you can enter the variable name and an arbitrary value. We do not allow the names of variables to contain anything other than upper- or lower-case letters, numbers, and underscore ( `_` ) characters. This guarantees that all environment variable definitions can be used on all platforms. Variable values are not so limited.



### 9.15.2. Editing an existing environment variable definition

Select the Edit button. Before selecting this option, you must first highlight one of the environment variables in the **Env Vars** List as follows:



After selecting the Edit option, a Dialog will appear with the current values already set, ready for editing.

### 9.15.3. Set by browsing

The "Set by Browsing" option in the solver **Env Vars** tab is used to set variables in bulk. This is done by running a user-supplied program or importing a user-supplied file located in

`$HOME/LSOPT_SCRIPTS`

Activate the "Set by browsing" button within the **EnvVars** tab in order to select from the available executables and or files. Executables, \*.env files and \*.lstcsh files are currently the only valid file types. You can redefine the search location for scripts by setting an environment variable LSOPT\_SCRIPTS to the desired directory location.

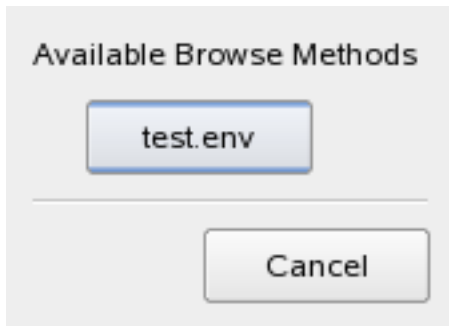
NOTE: Windows does not set a HOME environment variable, even though there is a home directory for each user. A command prompt, for example, opens in the home directory of the user.

*.env files*

The simplest way to import a group of environment variables into LSOPT is through the use of an environment variable file. For example, create a file “test.env” in \$HOME/LSOPT\_SCRIPTS with these five lines in it

```
# This is a comment line
LSTC_LICENSE=network
LSTC_LICENSE_SERVER='server1 server2 server3'
LSTC_LICENSE_PORT=31020
LSTC_EXE=ls971_R4
```

Save the file. When you invoke the “Set by Browsing” feature, a window will appear where you can select the “test.env” file as shown:



Selecting this file imports all four of the variables shown above. There are a few formatting rules that should be observed for a “.env” file:

1. Any line which begins with # ! @ \$ % & ; : is treated as a comment line.
2. NAME=VALUE lines should not contain white space between NAME and =, or between = and VALUE.
3. White space may appear before NAME, at the beginning of a line
4. If VALUE contains white space, then use NAME='VALUE' as shown above. (This is an acceptable form, whether or not spaces appear in VALUE.)

*Executables*

You can import a group of environment variables by creating an executable that prints a space-separated list of NAME=VALUE pairs, all on one line. This list must appear in a *single* line of output, the last line of output from the program; previous lines of output are ignored. There should be no space between NAME and =, or between = and VALUE. If VALUE must contain spaces, then use NAME='VALUE'.

For example, the single output line shown below is valid (it has been broken for display purposes only):

```

exe=/home/trent/LSTC/PERL/lldyna-caec01_pbs_sub.pl menu=batch time=1:00
host=abcdefgh07 procs=1 jobname='My Job' project=isd email=No delay=No
preemptable=No version='LS-DYNA 970 MPP SP 6763' ioloc=/home/trent
inpfile=DynaOpt.inp mem1=auto mem2=auto pfile=Generic dumpbdb=No dynamore=No
clean=No tail=No copycont=No optimization=LsOpt

```

The main reason to use a program to set variables in bulk, instead of a “.env” file, is that an interactive program can take advantage of the “Edit browse list” feature, which is described a little later in this section.

### *.lstcsh files*

These types of files are specialized script files which requires the interpreter “lstcsh” (or “lstcsh.exe” on the PC). This interpreter is included in the LSOPT distribution, and it is designed to generate the output format described for “Executables” above. It is also designed to allow interaction with the “Edit browse list” feature. These scripts define graphical programs with standard user-interface components for selecting, modifying, or specifying environment variables. For example, if you have complex and specialized queuing options, then “.lstcsh” script files could be useful for you. Please contact LSTC for more information.

### Set by Browsing

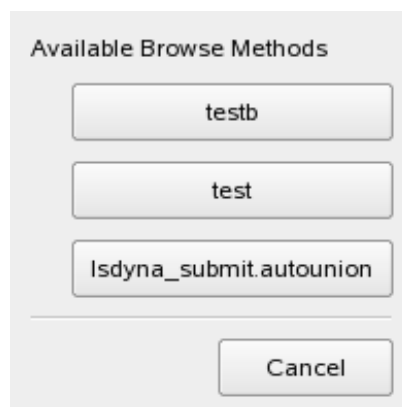
After selecting the **Set by browsing** option, a dialog of buttons will appear, one for each executable, .env file, or .lstcsh file in the LSOPT\_SCRIPTS environment. For example, suppose this is the directory listing for \$HOME/LSOPT\_SCRIPTS :

```

-rwxr-xr-x 1 joe staff 13597 2009-12-01 18:09 lldyna_submit.autounion*
-rw-r--r-- 1 joe staff 13597 2009-12-01 17:46 stdin.save
-rwxr-xr-x 1 joe staff 9 2009-08-10 14:23 test*
-rwxr-xr-x 1 nielen staff 9 2009-08-10 14:26 testb*

```

Then, when you select the Set by browsing option, the following dialog appears:



A valid browse command must print environment variable definitions to standard output in the form



name='value'; the single quotes are optional if value does not contain spaces. A valid sample output is shown below (the line is wrapped because of its length).

```
exe=/home/trent/LSTC/PERL/lldyna-caec01_pbs_sub.pl menu=batch time=1:00
host=abcdefgh07 procs=1 jobname='My Job' project=isd email=No delay=No
preemptable=No version='LS-DYNA 970 MPP SP 6763' ioloc=/home/trent
inpfile=DynaOpt.inp mem1=auto mem2=auto pfile=Generic dumpbdb=No dynamore=No
clean=No tail=No copycont=No optimization=LsOpt
```

All of the name='value' strings are directly imported into the Env Vars tab in bulk. In addition to these **Browse List** variables, a special browse variable is created that should not be edited. This variable records the program name used to create the Browse List.

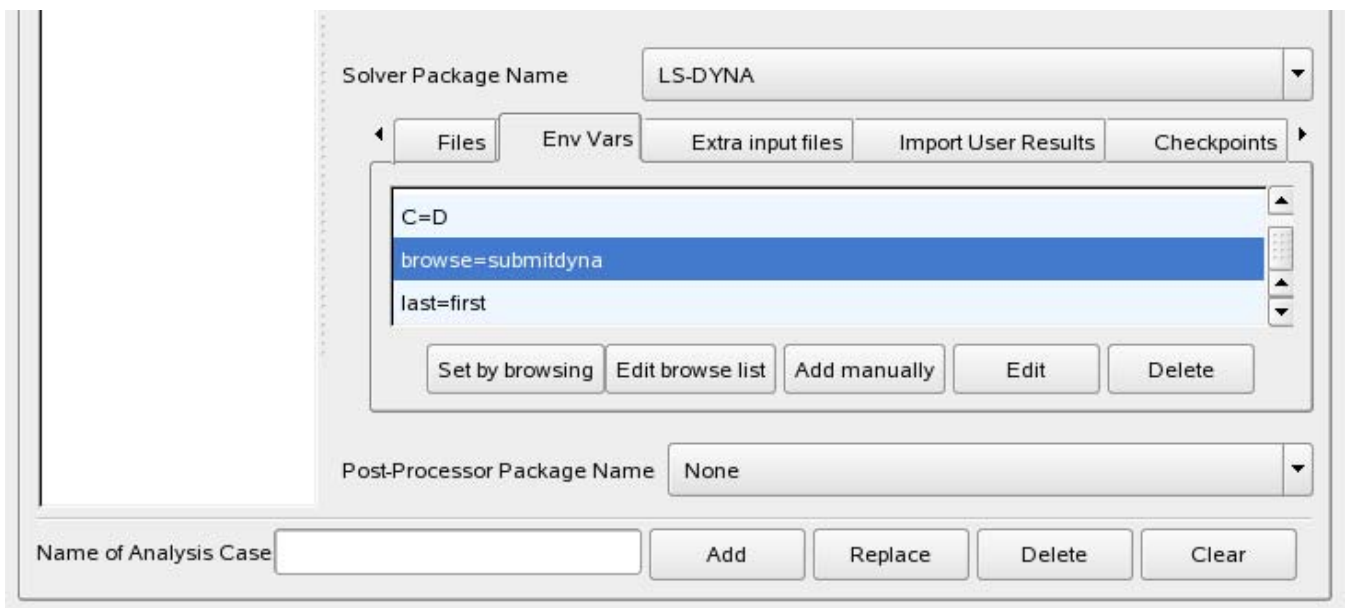
NOTE: All variables must be printed on one line, which must be the last line of output from the program. Lines before the last line are ignored.

WARNING: The user-supplied browse program should never define the browse variable in its output. The name `browse` should be treated as a reserved name.

A simple Linux browse command could be a shell script:

```
#!/bin/bash
echo This line is ignored. Only the last line survives
echo A=B C=D
```

Running the browse command shown above will import two variables, A and C, into the browse list.



NOTE: Strings in the Env Vars List appearing above the `browse=` line are all part of the Browse List.

Strings in the Env Vars tab that appear below `browse=` are never part of the Browse List. User-defined environment variables will always follow after the `browse` variable definition (e.g., `last=first` in the figure above was not defined by the `browse` command.)

#### 9.15.4. Edit browse list

Select the **Edit Browse list** button. Choosing this option does nothing unless a Browse List has been previously created. If a valid Browse List is present in the Env Vars tab, then selecting this option will run the original program that created the Browse List, together with all of the current Browse List options passed as command line arguments, one per existing environment variable. Each command-line argument has the form *name=value*. However ‘value’ is not single-quoted because each *name=value* argument is a separate command-line argument. The customer-supplied `browse` command should offer the user an opportunity to edit the existing variables, and the `browse` command should return the newly edited list on one line, in the same format as described above. This would normally be done through some sort of graphical user interface. The returned list will be used to replace all of the previous Browse List.

The next example script returns an initial Browse List consisting of two variables, A and C. Invoking the editing feature appends a new variable (`tN=N`) to the list.

```
#!/bin/bash
echo This line will be ignored. Only the last line survives.
if [ "$1" == "" ]; then
    echo A=B C=D;
else
    echo $* "t"$$$"=$$$;
fi
```

When this script is invoked using the “Create by Browse” feature, there are no command-line arguments, and the script prints “A=B C=D” to standard output. However, when the script is invoked using the edit feature for the first time, two command-line arguments “A=B” and “C=D” are passed to the script. This time the return line consists of the original command-line arguments (printed using `$*`) and `tN=N`, where N is the PID of the shell process. If the editing feature is invoked a second time, then three command-line arguments are passed to the script (“A=B”, “C=D”, and “tN=N”). Another new variable `tN` is appended, where N is the newest PID of the script process. This sample script has little practical value, except to illustrate how existing variable settings are passed by command-line to the previous `browse` command, and to illustrate how one can use the editing feature to modify or add new variables.

Executing the 'Edit Browse List' will cause the original `.env` file to be reread, which is convenient for testing purposes.

Note: The `browse` command can ABORT the replacement operation by printing a blank line to the standard output and immediately terminating. Otherwise the current Browse List may be deleted. If the `browse` command abnormally terminates, then an error box will appear with a title bar indicating that the command failed.

#### 9.15.5. How the browse list is used by LSOPT

The **Browse List** (indeed, the complete **Env Vars List**) is used to set environment variables before running the solver command specified by LSOPT. However, if the first variable returned by the `browse` command is

**exe**, then a pre-processing command is run before running the actual solver command. The pre-processing command is the value of the **exe** variable. The pre-processing command has a command line

```
$exe var1=$var1, var2=$var2, ... varN=$varN
```

That is, the command executed is the value of the **exe** variable; additional command line arguments consist of all **Browse List** strings with a comma delimiter appended to each intermediate one. (The final argument is not followed by a comma.)

*Note:* Such a pre-processing command is always run from within the current **LSOPT Job Directory**. Therefore, any file that the pre-processing command references must be specified by a fully-qualified path or must be interpreted relative to the current **LSOPT Job Directory**. So, the **LSOPT Case Directory** will be ".." and the **LSOPT Project Directory** will be "../..".

## 9.16. Killing jobs

### 9.16.1. Overview of How Jobs are Killed

There are only a few methods which are used to kill a job, regardless of how the job is run, and regardless of the type of job.

- **A D3KIL file** is created to kill LS-DYNA jobs. LS-DYNA will save its data, update restart files, and exit cleanly. Unfortunately, depending on the type of job, LS-DYNA may not be able to check for the presence of a D3KIL file in any short period of time. This is especially true of large implicit jobs where large matrix solves are not interrupted for efficiency reasons.
- **SIGINT signal (Ctrl+C under Windows)**. Many programs are designed to trap such signals and to exit gracefully. Others may deliberately ignore such signals. This signal cannot be used to kill LS-DYNA jobs, because LS-DYNA traps this signal to activate a sense switch.
- **SIGTERM signal (Ctrl+Break under Windows)**. This is a little more forceful than SIGINT or Ctrl+C option for killing programs. Programs which ignore the SIGINT or Ctrl+C may exit upon receiving this signal, either voluntarily or involuntarily. Programs are allowed to catch or to ignore such signals.
- **SIGKILL signal (TerminateProcess() process under Windows)**. This is the most reliable method for killing a job, but it may result in lost resources because programs cannot generally catch or ignore such kill requests. Linux processes killed in this way will not be able to flush unwritten data, or to close files. Linux jobs killed in this way may result in <defunct> processes. Windows processes killed in this way may be unable to properly release DLL resources. This Windows kill option is the same mechanism used by the Windows Task Manager to 'force' kill a job, and the same warnings apply.
- **A queuing system job deletion command** may be issued. This is generally results in a sure kill of a remote running job, but there is no opportunity to save files or other data. This is a remote queuer-specific version of the SIGKILL option.

The biggest determining factor in how a job is killed is the manner in which the job is scheduled:

1. Locally;

2. Indirectly through a **runqueuer/wrapper** solution;
3. Indirectly using the **HONDA queuing** option;
4. Indirectly using the **BLACK BOX queuing** option.

There are LS-DYNA and non LS-DYNA jobs. How a job is killed depends on how it is run and queued. Queued jobs can be stuck in strange states that require special handling. LS-DYNA jobs are handled differently in order to preserve data that might be useful.

**Case 1 (Killing Local Jobs):** Local jobs are killed using D3KIL files and/or signals.

- The first attempt to kill an LS-DYNA jobs is done by creating a D3KIL file. The SIGTERM method is used if LS-DYNA does not respond within 10 minutes. The SIGKILL method is used if LS-DYNA does not respond to SIGTERM within 15 seconds. If LS-DYNA does not respond shortly afterwards, then the job is abandoned.
- Non LS-DYNA jobs are killed using signals, starting with SIGINT (or SIGTERM). If that fails after about 10 minutes, then SIGTERM is used. If that also fails, then a SIGKILL signal is delivered. If that fails, then the job is abandoned.

**Case 2 (Killing Jobs run using runqueuer/wrapper):** This option is used to monitor/control jobs which are run remotely using a queuing system. A local runqueuer process communicates with a remote wrapper process in order to relay terminal I/O, to transfer files, and to deliver signals.

If you try to kill a job started using runqueuer/wrapper before these programs have been able to negotiate a connection, then runqueuer will exit, and the remote job will be unable to start.

If you try to kill a job after runqueuer and wrapper have negotiated a connection, then the method of killing the job is much like that for a locally-run job.

- If the remote job is an LS-DYNA job, then a D3KIL file is created on the remote side. If LS-DYNA fails to exit after about 10 minutes, then the SIGTERM is used to kill LS-DYNA. If that also fails, then the SIGKILL method is used to kill LS-DYNA. If that fails, then the runqueuer/wrapper programs exit, and a queuing system job delete command is issued. The job is then abandoned.
- If the remote job is a non-LS-DYNA job, then the SIGINT (or SIGTERM) is first used. This is done approximately every 15 seconds. If that fails, then the SIGTERM method is used. If that also fails, then the SIGKILL method is used. If that fails, then the runqueuer/wrapper programs exit, and a queuing system job delete command is used. The job is then abandoned.

**Case 3 (Jobs are run using the HONDA queuing option):** This queuing option was created to work in environments where TCP/IP connetions from compute clusters back to LS-OPT were either impractical, undesirable, or not allowed. Commands are executed using user-supplied queuing scripts to run the jobs on remote nodes.

If you try to kill a job managed using this option, then a job id/name must be known, because the only way to kill the job is using the queuing system job delete command. Queuing scripts can hang for a time before

finishing. Therefore, we wait for 2 minutes to find the job name/id in the script output. After that we abandon the job.

*NOTE:* There are times when an LsoptJobCheck script may be run. If this script is busy when the job is killed, then we wait indefinitely for the script to complete. That way we prevent <defunct> processes.

**Case 4 (Jobs are run using the BLACK BOX queuing option):** This option was created to deal with an unknown queuing system, and to provide a general mechanism for progress monitoring using scripts created by the user. Jobs are submitted using a user-supplied submit script to run jobs on remote nodes.

If you try to kill a job managed using this option, then a job id/name must be known, because the only way to kill the job is using a user-supplied LsoptJobDel script. Queuing scripts can hang for a time before finish. Therefore, we wait for 2 minutes to find the job name/id in the script output. After that we abandon the job.

A script named LsoptJobCheck runs periodically for each job. A job for which this script is running is not killed or abandoned until this script completes. This is done to avoid <defunct> processes.

### 9.16.2. Killing Jobs using LS-OPT, LS-OPTui, and LSKILLJOB.

This is a program supplied with LS-OPT for the purpose of killing jobs managed by the **lscheduler** process. Jobs may be killed in bulk or killed individually using this program. The **lskilljob** program resides in the LS-OPT installation directory, along with the other executables.

#### Killing All Jobs in Bulk

Jobs can be killed in bulk from

- LS-OPT using the sense switch **sw1**.
- LS-OPTui Run Panel.
- Using the LSKILLJOB command line utility.

The LSKILLJOB program is a separate executable located in the main directory of the LS-OPT distribution. The syntax to invoke the bulk kill option using LSKILLJOB is:

```
lskilljob -kill
```

All three programs contact the LSCHEUDLER job scheduling process in order to kill jobs. The LSKILLJOB program must be able to contact the LSCHEUDLER process in order to kill jobs; so it imperative that LSKILLJOB is run in the main project directory for the currently running LS-OPT process. LSKILLJOB consults a file named “lsopt.control” for information about how to connect to the LSCHEUDLER process. If “lsopt.control” cannot be found, or if LSCHEUDLER is not currently running, then LSKILLJOB prints the following error message and then terminates:

```
Kill request status:Failed to open lscheduler
```

## Kill One Job

A single job may be killed using LS-OPTui, or using the standalone LSKILLJOB program. The basic kill job option requires a job number and no other command line options. As described above, the LSKILLJOB program must be run from the main LSOPT project directory

```
lskilljob job_number
```

There are several errors which can occur during such a request, and by are diagnosed by the following LSKILLJOB error messages

```
Kill request status:Job not running
Kill request status:Invalid parameter
Kill request status:Target job cannot be killed,
    or job id out of range
Kill request status:Failed to open lscheduler
```

If the command succeeds (which does not mean that the job is immediately killed,) then you should see a success message

```
Kill request status:Success
```

This indicates the that the job number is a valid, running job, and that the kill operation has been initiated.

## Kill Level

Whenever a job is killed using the bulk kill option, or the LSKILLJOB kill described above, the kill operation proceeds in levels or stages. For LS-DYNA there are three stages. For some jobs, there are only two.

### LS-DYNA Jobs (non-queued)

1. A D3KIL file is created in the working directory of the LS-DYNA job.
2. A SIGTERM signal is sent under Linux, or a Ctrl+Break under Windows.
3. A SIGKILL signal (kill -9) is sent under Linux, or is forcibly terminated under Windows, using the same force-kill mechanism as the Windows Task Manager.

### LS-DYNA Jobs (queued with runqueuer/wrapper)

1. If the user-defined script failed to return a job name or job id, then a request is made to the runqueuer program to exit. The job is then abandoned.
2. If the user-defined script has returned a job name or job id, but the remote side has not yet connected back to the local side, then the queuer-specific job delete command is issued, and the runqueuer is instructed to exit. The job is then abandoned.
3. If the remote wrapper program has connected back to the local runqueuer, then a D3KIL is created by the remote wrapper, and we wait for LS-DYNA to exit.

4. This level pertains only to the case where the remote wrapper has connected, but the D3KIL file has failed. The wrapper program is now instructed to send a SIGTERM signal to LS-DYNA.
5. This level pertains only to the case where the remote wrapper has connected, but the D3KIL and/or the SIGTERM signal have failed. The wrapper program is now instructed to send a SIGKILL signal to LS-DYNA.

**Other Jobs (non-queued)**

1. A SIGINT (or SIGTERM) signal is sent under Linux, or a Ctrl+C (or a Ctrl+Break) is delivered under Windows.
2. A SIGTERM signal is sent under Linux, or a Ctrl+Break under Windows.
3. A SIGKILL signal (kill -9) is sent under Linux, or is forcibly terminated under Windows, using the same force-kill mechanism as the Windows Task Manager.

**Other Jobs (queued with runqueuer/wrapper)**

1. If the user-defined script failed to return a job name or job id, then a request is made to the runqueuer program to exit. The job is then abandoned.
2. If the user-defined script has returned a job name or job id, but the remote side has not yet connected back to the local side, then the queuer-specific job delete command is issued, and the runqueuer is instructed to exit. The job is then abandoned.
3. If the remote wrapper program has connected back to the local runqueuer, then the wrapper is instructed to deliver a SIGINT (or SIGTERM) signal to the process.
4. This level pertains only to the case where the remote wrapper has connected, but the signal has failed to kill the process. The wrapper program is now instructed to send a SIGTERM signal to the process.
5. This level pertains only to the case where the remote wrapper has connected, but the SIGINT and/or SIGTERM signals have failed to kill the process. The wrapper program is now instructed to send a SIGKILL signal to LS-DYNA.

**All BLACKBOX Queued Jobs**

1. If the BLACKBOX queuing script has been executed, but no valid job id or job name has yet been detected, then we queue a kill event until the job id or job name can be found, and any running queuing script or LsoptJobCheck script has finished. We then execute LsoptJobDel to kill the job. If this condition has persisted for 120 seconds since starting the queuing script, then the job is abandoned.
2. If the BLACKBOX queuing script has returned a valid job id or job name, but the queuing script or LsoptJobCheck is currently running, then we queue a kill event until the script in question has finished. We then execute LsoptJobDel to kill the job.
3. If the BLACKBOX queuing script has returned a valid job id or job name and has completed, and if there is no queuing script or LsoptJobCheck in progress, then we kill the job using the user-supplied LsoptJobDel script. The job is then abandoned.
4. If a queuing script has not yet reported a valid job id or job name, then the job is abandoned.
5. If an LsoptJobCheck script is stalled, we send a SIGKILL to the script, and the job is abandoned.
6. The job has been abandoned by this point.

### All HONDA Queued Jobs

1. If the HONDA queuing script has been executed, but no valid job id or job name has yet been detected, then we queue a kill event until the job id or job name can be found.
2. If the HONDA queuing script has failed to return a valid job id or job name for 120 seconds, then the job is abandoned.
3. If an LsoptJobCheck script is in the process of determining a final exit status for the job, then we ignore the kill in favor of waiting for the job check script to finish.
4. If the HONDA queuing script has returned a valid job id or job name, then the queuing delete command is executed, and the job is abandoned.
5. If the HONDA queuing script has been executed, but still has not returned a valid job id or job name, then the job is abandoned.
6. The job has been abandoned by this point.

### Increasing the Kill Level

The bulk kill may spend up to 10 minutes in the first stage (level 0) before proceeding to level 1. It then executes level 1 kill operations, and waits only 15 seconds before proceeding to the final “sure-kill” level 2 kill operations. The kill will remain in the final stage only for a short time before abandoning the job entirely, possibly leaving behind a job that refuses to exit. Some jobs are abandoned at level 1, depending on the type of job and the queuing options. Jobs abandoned at level 1 do not usually result in lost resources.

It is not generally advisable to elevate the kill level for a particular job, but this is an option which can be reasonably invoked by the user. For example,

```
lskilljob job_number 1
```

will cause the kill routines to spend only 15 seconds waiting for level 0 kill operations to succeed before moving to level 1 kill operations. LSHEDULER will then try one level 1 kill operations, and wait 15 seconds before trying the final 'sure-kill' level 2 kill operations. Executing

```
lskilljob job_number 2
```

will cause the kill routines to spend only 15 seconds waiting for level 0 kill operations to succeed before moving to the final level kill operations (may be level 2 or, in some cases, may be level 1.)

If you execute LSKILLJOB using level 1, and execute it again immediately afterwards, then the wait period for the level 0 kill is eliminated, and level 1 kill operations are executed immediately. Executing LSKILLJOB immediately again then aborts the 15-second wait period for level 1 kill operations, and level 2 kill operations are immediately executed. This will make the impatient user happy, but may surprise other users. This is by design in order to create a responsive command.

Once the kill level is elevated, then all subsequent LSKILLJOB commands work at the same or higher level according to kill level escalation rules, making it unnecessary to add the kill level argument again. The kill



level cannot be lowered by using the option kill level command line option. And a kill operation cannot be aborted.

**Warnings:**

- Once a job kill operation is started, it cannot be canceled.
- The kill level 2 can result in lost kernel resources and incorrectly closed files. Linux systems may leave behind a <defunct> job, and files may be incompletely written. Windows systems may lose resources because DLLs are not properly detached, and may even destabilize the system; files may also be corrupted or incompletely written.
- LS-DYNA may be unable to check for the presence of a D3KIL file for a considerable period of time. This usually occurs with implicit jobs where long matrix calculations are not interrupted for reasons of efficiency. 10 minutes should be sufficient for nearly all explicit LS-DYNA runs.

**Termination Status for Killed Jobs**

This is a tricky issue, where the defaults are usually appropriate, but not always. For that reason, you may wish to set the final job status to ERROR, ABORTED, or KILLED using the lskilljob command.

You can specify the final exit ERROR, ABORTED or KILLED as follows:

```
lskilljob job_number [level] error
lskilljob job_number [level] aborted
lskilljob job_number [level] killed
```

Commands marked with ERROR will not be restarted using LS-OPT, and results from these commands are ignored. The finished file will contain the string

```
E r r o r   t e r m i n a t i o n
```

Commands marked with ABORTED will be restarted according to the retry rules defined in LS-OPT. If the process has reached its maximum number of allowed retries (which may be 0,) then the process is flagged with a final status of ERROR. Otherwise, the command is retried after a suitable wait period. A finished file is created only in the latter ERROR case and, in that case, will contain

```
E r r o r   t e r m i n a t i o n
```

The KILLED option is used by the bulk kill option so that LS-OPT will retry the job upon restart; however, this job may not restart if LS-OPT has beyond the point where the results of this job are needed. The finished file will contain the string

```
F o r c e d   t e r m i n a t i o n
```

If a bulk kill is in effect when you kill the job using LSKILLJOB, then the default final job status is KILLED, which is the same as all other jobs killed during the bulk kill. However, if a bulk kill is not in

effect when you kill the job using LSKILLJOB, then the default final job status is ERROR. The assumption is that any job killed during a bulk kill should be flagged the same as all other jobs; the intent of the user is interpreted only as an action to speed along the bulk kill by targeting certain jobs which are slow to exit. However, if just one job is killed outside of a bulk kill, then the assumption is that the job has failed in some way, and should be flagged with ERROR; that way the job will not be restarted.

### 9.16.3. Flagging a Job for Restart

If you kill a job using LSKILLJOB, then **you can also flag the job for restart**

```
lskilljob job_id [kill_level] restart [wait_time_seconds]
```

If you do not specify a wait time, then a default value of 0 is used, thereby instructing the LSCHEMULER process to reschedule the job as soon as there are resources to do so. The status returned by this command is the same as for the corresponding kill command without the restart option.

This option is designed for cases where a temporary problem has caused a job to hang or misbehave, and you want to kill and restart the job after waiting long enough to correct the problem. For example, a queuing system may have failed, and the job was lost; so the submit script failed to return a job id/name. Or perhaps the queuing system discarded the job for some reason, and LS-OPT has no way of knowing that the job cannot complete.

Another designed use of this command is in situations where a job has ERROR terminated because of some resource problem, and you want to schedule the job to restart before LSCHEMULER terminates, so that LSOPT can use the corrected results. To flag a completed job for restart, issue the LSKILLJOB command with the `-restart` option

```
lskilljob job_id -restart [wait_time_seconds]
```

The LSCHEMULER process will restart the process as soon after the specified time wait as resources are available to start the job.

You may **cancel any pending restart** option up until the time the job actually starts. This is done using the `cancel` option for the LSKILLJOB command

```
lskilljob job_id -restart job_to_restart cancel
```

This cancels any pending restart operation initiated with the LSKILLJOB command. This command does not cancel other types of pending restart events caused by an “A b o r t e d” termination status.

You may **modify a pending restart wait time** before the job has restarted by issuing the command

```
lskilljob job_id -restart wait_time_seconds
```

This command does not function for running jobs, unless a kill is already scheduled, in which case the restart option and restart time field are updated. If a kill has not yet been scheduled for the job, then LSKILLJOB will report an error

```
Restart status:Job is running, use kill with restart option
```

Other possible returns are

```
Restart status:Success
```

```
Restart status:Cannot restart, job never started
```

```
Restart status:Job id out of range
```

```
Restart status:Already flagged for retry (no action taken)
```

```
Restart status:Invalid argument
```

```
Restart status:Failed to open lscheduler
```

```
Restart status:I/O error while negotiating with lscheduler
```

### **Remarks on Restarting Jobs:**

- Restart events should be considered transient, persisting only during the time that LSCHEUDLER is running. If you issue a bulk kill of all jobs, then any pending restart events are discarded. The affected jobs are not automatically restarted at a later time.
- In future versions, the user will be able to schedule a restart for a job, even if the LSCHEUDLER is not running. Such restart events will be persistent.
- A job which has never been started cannot be flagged for restart.
- Jobs which are running cannot be flagged for restart without also issuing a kill operation.

# 10. Interfacing to a Solver, Preprocessor or Postprocessor

This chapter describes how to interface LS-OPT with a simulation package and/or a parametric preprocessor. Standard interfaces as well as interfaces for user-defined executables are discussed.

## 10.1. Parsing, copying and transmitting of LS-DYNA input and include files

The handling (parsing, copying and transmitting) of input and include files by LS-OPT is automated. The following rules apply:

1. LS-OPT handles four main types of solver input files, namely the (i) main input file, (ii) include files, (iii) extra files and (iv) an append file. Input files are parsed to substitute parameter values (see Sections 10.2 and 10.3) and then copied to the run directories or transmitted onto a computer cluster for a remote run.
2. The **main input file** is copied to the run directory, parsed to substitute the new parameter values and then renamed. For LS-DYNA, the file is renamed to *DynaOpt.inp*. Each solver types has its own input file.
3. **Include files** may also contain parameters and are also parsed and copied (or transmitted) if the include file is specified in the keyword file *without a path*, for example:

```
*INCLUDE  
input.k
```

If a path is specified for an include file, e.g.

```
*INCLUDE  
C:\path\myinputfiles\input.k
```

the file will not be copied, parsed or transmitted.

4. If the main input file is placed in a subdirectory of the main working directory and is specified with a relative path, e.g. *myinputfiles/input.k*, the directory (in this case *myinputfiles*) becomes a file environment for any include files which may also be placed in this directory. Therefore all include files specified without a path will automatically be copied (or transmitted) from this sub-directory (*myinputfiles*) to the run directories.

5. **Extra files** can be specified individually and are always parsed to substitute parameter values and copied (or transmitted). This feature can therefore be used to force file copying. See also Section 10.6 for more detail.
6. An **Append file** is simply a file which is appended to the main input file. The append file is also parsed for parameter value substitution. After appending, the main input file with its appendage is renamed e.g to *DynaOpt.inp*. It is suggested that an include file be used instead of an appended file since this is a more natural operating mode when managing LS-DYNA input.

## 10.2. Labeling design variables in a solver and preprocessor

Parameters specified in input files are automatically identified for the following packages:

Package	Native parameters recognized in input file	LS-OPT Parameter Format recognized (see Section 10.2.1)	include files recognized in input file
LS-DYNA <sup>®</sup>	Yes	Yes	Yes
LS-PREPOST <sup>®</sup>	Yes	Yes	Yes
MSC-NASTRAN <sup>6</sup>	Yes	Yes	No
ANSA	Yes	Yes	Yes
HyperMorph <sup>7</sup>	Yes	Yes	No
TrueGrid <sup>8</sup>	No	Yes	Yes
LS-INGRID	No	Yes	Yes
User-defined	N/A	Yes	No

LS-OPTui will automatically recognize the native and LS-OPT parameters for the formats indicated in the table and display them as ‘Constants’ in the ‘Variables’ panel. The user can then change these constants to variables or dependents. The parameter names cannot be changed in the GUI so, if desired, must be changed in the original solver input file. A lock icon adjacent to the variable name indicates that the parameter names were imported from the input or include files.

The ‘include’ files are also scanned wherever this feature is available making it nonessential to append any files or define extra files. Include files which are specified with a path, e.g. “../../car5.k” or “/home/jim/ex4a/car6.k” are not copied to the run directories and no parameter substitutions will be made in these files. This is solely to prevent unnecessary file proliferation. The user must however ensure that files, which are to be distributed to remote nodes through a queuing system (see Section 9.12), do not contain any path specifications. These files are automatically transmitted to the relevant nodes where the solver will be executed. See also Section 10.1.

Extra files can be added for copying to run directories and substituting variables. If parameters are specified in include files with path specifications, these files should be specified as extra files. See Section 10.6.

The LS-OPT parameter format described next is recognized in all types of input files.

<sup>6</sup> Registered Trademark of MSC Software, Inc.

<sup>7</sup> Registered Trademark of Altair Engineering, Inc.

<sup>8</sup> Registered Trademark of XYZ Scientific Applications, Inc.

### 10.2.1. The LS-OPT parameter format

LS-OPT provides a generic format that allows the user to substitute parameters in any type of input file. The parameters or expressions containing parameters must be labeled using the double bracketed format `<<expression: [i]field-width>>` in the input file.

The *expression* field is for a FORTRAN or C type mathematical expression that can incorporate constants, design variables or dependents. The optional *i* character indicates the integer data type. The field width specification ensures that the number of significant digits is maximized within the field width limit. The default field width is 10 (commonly used in e.g. LS-DYNA input files). E.g. a number of 12.3456789123 will be represented as 12.3456789 and 12345678912345 will be represented as 1.23457e13 for a field-width of 10.

A field width of zero implies that the number will be represented in the “%g” format for real numbers or “%ld” format for integers (C language). For real numbers, trailing zeros and a trailing decimal point will not be printed. This format is not suitable for LS-DYNA as the field width is always limited. Real numbers will be truncated if specified as integers, so if rounding is desired the “nearest integer” expression should be used, e.g. `<<nint(expression)>>`.

A record of the specified input files and parameters can also be checked in the `lsopt_input` file.

```

-----
L I S T   O F   I N P U T   F I L E S   U S E D   B Y   L S - O P T
-----
SOLVER: 1
-----
File name                                     |-----|-----|-----|
                                         Type   Utility  Parameter Occur.
                                         -----
                                         Native  LS-OPT
-----
main.k                                       |-----|-----|-----|
  ../../car5.k                             |-----|-----|-----|
-----
L I S T   O F   I N C L U D E   F I L E S   A N D   P A R A M E T E R S
-----
=====
File Name           Include Parameters Status      Time Stamp
                    Files
=====
main.k              1           2           OLD           Thu Apr 1 14:39:11 2004
=====

List of Include Files for "main.k"
-----
Include File Name
-----
  ../../car5.k
-----

```

```

List of Parameters found in "main.k"
-----
Parameter Name    Value    Type
-----
tbumper           1        *PARAMETER
thood             3        *PARAMETER
-----

```

Inserting the relevant design variable or expression into the preprocessor command file requires that a preprocessor command such as

```
create fillet radius=5.0 line 77 line 89
```

be replaced with

```
create fillet radius=<<Radius*25.4:0>> line 77 line 89
```

where the design variable named `Radius` is the radius of the fillet and no trailing or leading spaces are desired. In this case, the radius multiplied by the constant 25.4 is replaced. Any expression can be specified.

An alternative option would be to specify:

```
create fillet radius=<<Radius_scaled:0>> line 77 line 89
```

while specifying the *dependent* `Radius_scaled` as a function of independent variable `Radius`, such that `Radius_scaled = Radius * 25.4`. This specification is done in the ‘Variables’ panel or command file.

Similarly if the design variables are to be specified using a Finite Element (LS-DYNA) input deck then data lines such as

```
*SECTION_SHELL
1, 10, , 3.000
0.002, 0.002, 0.002, 0.002
```

can be replaced with

```
*SECTION_SHELL
1, 10, , 3.000
<<Thickness_3>>, <<Thickness_3>>, <<Thickness_3>>, <<Thickness_3>>
```

to make the shell thickness a design variable.

An example of an input line in a LS-DYNA structured input file is:

```
* shfact z-integr printout quadrule
.0 5.0 1.0 .0
* thickn1 thickn2 thickn3 thickn4 ref.surf
<<Thick_1:10>><<Thick_1:10>><<Thick_1:10>><<Thick_1:10>> 0.0
```

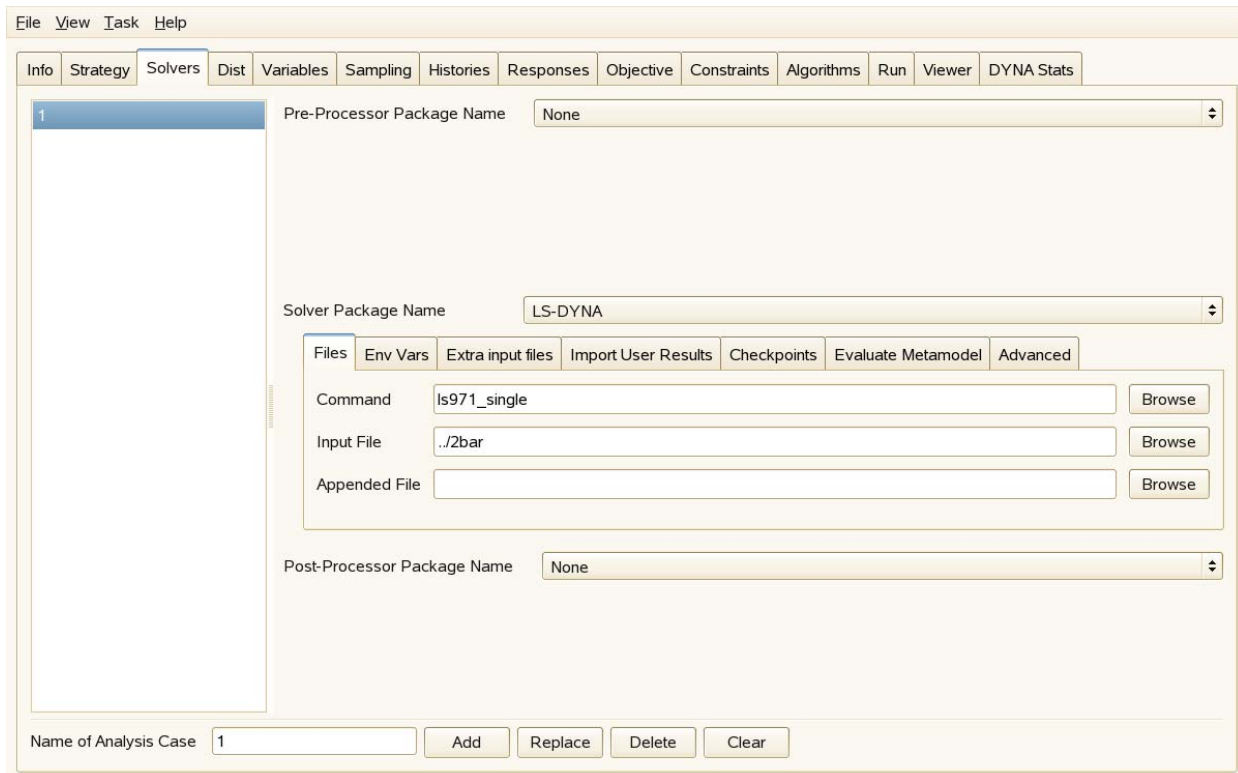
The field-width specification used above is not required since the default is 10. Consult the relevant User's manual for rules regarding specific input field-width limits.

### 10.3. Interfacing to a Solver

In LS-OPT<sub>ui</sub>, solvers are specified in the Solver panel (Figure 10-1):

Both the preprocessor and solver input and append files are specified in this panel. Multiple solvers (as used in multi-case or multi-disciplinary applications) are defined by selecting 'Add solver'. The 'Replace' button must be used after the modification of current data.

The name of the analysis case is used as the name for the subdirectory.



**Figure 10-1: Solver panel in LS-OPT<sub>ui</sub>**

**Execution command.** The command to execute the solver must be specified. The command depends on the solver type and could be a script, but typically excludes the solver input file name argument as this is specified using a separate command. The execution command may include any number of additional arguments.

**Input template files.** LS-OPT converts the input template to an input deck for the preprocessor or solver by replacing the original parameter values (or labels) with new values determined by the sampling procedure.



During run-time, LS-OPT appends a standard input deck name to the end of the execution command. In the case of the standard solvers, the appropriate syntax is used (e.g. `i=DynaOpt.inp` for LS-DYNA). For a user-defined solver, the name `UserOpt.inp` is appended. The specification of an input file is not required for a user-defined solver.

**Appended file.** Additional solver data can be appended to the input deck using the `solver_append_file_name` file. This file can contain variables to be substituted.

**Include files.** These do not have to be specified as they are automatically and recursively searched by LS-OPT when given the name of the main input file (root file).

### Command file syntax:

---

```
solver software_package_identifier name_of_analysis_case
solver input file "solver_input_file_name"
solver command "solver_program_name"
solver append file "solver_append_file_name"
interval Time_interval_between_progress_reports < 15 > (not
available in LS-OPTui)
```

---

The following software package identifiers are available:

own	user-defined solver
dyna	LS-DYNA Versions prior to 960
dyna960	LS-DYNA Version 960/970
nastran	MSC-NASTRAN SOL 103

### 10.3.1. Interfacing with LS-DYNA

The first command demarcates the beginning of the solver environment.

#### *Example:*

```
$ Define the solver software to be used.
solver dyna960 'SIDE_IMPACT'
$ the data deck to be read by the solver.
  solver input file "ingrido"
$ the command to execute the solver.
  solver command "/alpha6_2/usr/ls-dyna/bin/ls970.single"
$ Extra commands to the solver.
  solver append file "ShellSetList"
```

More than one analysis case may be run using the same solver. If a new solver is specified, the data items not specified will assume previous data as default. All commands assume the current solver.

*Remarks:*

1. The name of the solver will be used as the name of the sub-directory to the working directory.
2. The command `solver package_identifier name` initializes a new solver environment. All subsequent commands up to the next “`solver name`” command will apply to that particular solver. This is particularly important when specifying `response name commandline` commands as each response is assigned to a specific solver and is recovered from the directory bearing the name of the solver. (See Section 14).
3. Do not specify the command `nohup` before the solver command and do not specify the UNIX background mode symbol `&`. These are automatically taken into account.
4. The `solver command name` *must not be an alias*. The full path name (or the full path name of a script which contains the full solver path name) must be specified.

The LS-DYNA restart command will use the same command line arguments as the starting command line, replacing the `i=input file` with `r=runrsf`.

### The \*PARAMETER format

The parameters specified under the LS-DYNA `*PARAMETER` keyword are recognized by LS-OPT and will be substituted with a new value for each of the multiple runs. These parameters should automatically appear in the Variable list of the GUI upon specification of the solver input file name. LS-OPT recognizes the “`i`” and “`r`” formats for integers and real numbers respectively and will replace the number in the appropriate format. Note that LS-OPT will ignore the `*PARAMETER_EXPRESSION` keyword so it may be used to change internal LS-DYNA parameters without interference by LS-OPT.

For details of the `*PARAMETER` format please refer to LS-DYNA User’s Manual.

### Check of the \*DATABASE cards

LS-OPT can perform some basic checks of the `*DATABASE` cards in the LS-DYNA input deck. The checks will be done using the input deck of the first run of the first iteration. The items checked are:

1. Whether the required binout data types are requested in the LS-DYNA input deck. For example, if LS\_OPT uses airbag data, then the LS-DYNA deck should contain a `*DATABASE_ABSTAT` card requesting binout output.
2. Whether the required nodes and/or elements are requested in the LS-DYNA output. For example, if the LS-OPT output request refers to a specific beam, then a `*DATABASE_HISTORY_BEAM` or a `*DATABASE_HISTORY_BEAM_SET` card must exist and refer to the beam in question. Note that `*SET_option_GENERAL` or `*SET_option_COLUMN` card will not be interpreted and that an output entity specified using `*SET_option_GENERAL` or `*SET_option_COLUMN` may be flagged incorrectly as missing; switch off the checking in this case.

The GUI allows this to be set as an advanced solver option.

**Command file syntax:**

---

```
solver check output on/off
```

---

**Altering the d3plot databases**

The following options are available:

1. Compress the d3plot database. All results except displacements, velocities, and accelerations will be deleted.
2. Transforming the results to a local coordinate system specified by three nodes. The first node is the origin and the other two nodes are used to define the coordinate systems. The coordinate system moves with the nodes. A file specified the three nodes is required. An example of the possible contents of the file: 1001 1002 1003. The file therefore consists of a single line.
3. Write the results for a user selected set of parts. A file specifying the list of parts to be included/excluded is required. The file consists of multiple lines with a single entry per line. The syntax of the file is:
  - *id* includes the part with *id*,
  - *id1-id2* includes the parts from *id1* to *id2*,
  - *-id* excludes the part with *id*. Only parts included with *id* or *id1-id2* can be excluded.

For example: 5

```
7-20  
-9.
```

The GUI allows this to be set as an advanced solver option.

This capability does not work with adaptivity.

The \*DATABASE\_EXTENT\_BINARY option in LS-DYNA also allows control over the size of the d3plot databases.

**Command file syntax:**

---

```
solver compress d3plot on/off  
solver compress d3plot nodes nodrel_filename  
solver compress d3plot extract parts_filename
```

---

*Example:*

```
$ set d3plot compress options
```

```
solver compress d3plot on
solver compress d3plot nodes "nodrel_nodes.txt"
solver compress d3plot extract "part_list.txt"
```

### 10.3.2. Interfacing with LS-DYNA/MPP

The LS-DYNA MPP (Message Passing Parallel) version can be run using the LS-DYNA option in the "Solver" window of LS-OPTui (same as the `dyna` option for the solver in the command file). However, the run commands must be specified in a script, e.g. the UNIX script `runmpp`:

```
mpirun -np 2 lsdynampp i=DynaOpt.inp
cat dbout.* > dbout
dumplib dbout
```

The solver specification in the command file is as follows:

---

```
solver dyna960 'crash'
solver command ".././runmpp"
solver input file "car5.k"
solver append file "rigid2"
```

---

#### Remarks:

1. `DynaOpt.inp` is the *reserved* name for the LS-DYNA MPP input file name. This file is normally created in the run directory by LS-OPT after substitution of the variables or creation by a preprocessor. The original template file can have a different name and is specified as the input file in the solver input file command.
2. `lsdynampp` is the name of the MPP executable.
3. The file `dumplib` for creating the ASCII database must be executable.
4. The script must be specified in one of the following formats:
  - path relative to the run directory: two levels above the run directory (see example above).
  - absolute path, e.g. `"/origin/users/john/crash/runmpp"`
  - in a directory which is in the path. In this case the command is:

```
solver command "runmpp".
```

### 10.3.3. Interfacing with the MSC-NASTRAN<sup>®</sup> solver (SOL 103)

The user can interface with the NASTRAN implicit solver (sol 103) for modal analysis using the `solver nastran solvername` command, or by selecting the MSC-NASTRAN option in the LS-OPTui. The `solver command "` can either execute a command, or a script. The substituted input file `NastranOpt.inp` will automatically be appended to the command or script. Variable substitution will be performed in the solver input file (which will be renamed `NastranOpt.inp`) and the solver `append file`. The `nastran` solver is required to generate a 'N o r m a l' termination command to

standard output at the end of simulation. This can be done by executing NASTRAN using a script with its last statement being the command (see remark 2):

```
echo 'N o r m a l'.
```

*Example:*

```
solver nastran 'MODAL'
solver command "/home/bin/myNastran"
solver input file "modal_analysis.dat"
```

*Remarks:*

1. The NASTRAN solver must not be run in the batch mode. This can be done by specifying the 'batch=no' option with the nastran command.
2. A 'N o r m a l T e r m i n a t i o n' statement must be issued after finishing the NASTRAN job. This can be easily done by using the following script as the solver command:

```
#=====
/home/bin/nastran 'batch=no' $1
echo 'N o r m a l T e r m i n a t i o n'
#=====
```

3. **Design Parameters:** The design parameters can be specified using one of the following two options:
  - o defrepsym: The design variables can be specified using the
 

```
defrepsym varname default
```

 statement. The design variable value is accessed using %varname%. The user must be careful to use the appropriate fieldwidth permitted by NASTRAN. This is the preferred option.
  - o The LS-OPT parameter format discussed in Section 10.2.1.
4. **Creating the Database:** In order to facilitate the creation of appropriate LS-OPT readable database, the user must include the following *DMAP* code at the beginning of the input deck.

```
=====
$ open the binary file
ASSIGN OUTPUT4='nastEigout.op4' UNIT=39 UNFORMATTED DELETE $ binary
$
$ solver
SOL 103
DIAG 5, 6, 8, 56
$
$ Matrix manipulation
MALTER 'call modefsrs' $ after modes are calculated
LAMX,,LAMA/LMAT/-1/0 $ convert eigenvalue table to matrix
MPYAD, MAA, PHA,/MTP/1 $ matrix multiplication
OUTPUT4 PHA, LMAT, MTP,,-1/39///16 $ output desired matrices
$
CEND
=====
```

The name of the output file (nastEigout.op4) and matrices (PHA, MAA, LMAT, MTP,...) must not be changed for successful reading of the binary file.

5. **Extracting data:** To extract NASTRAN modal analysis results, the users must use Nastran-Frequency type on the response panel instead of FREQUENCY type that is used for LS-DYNA.

### 10.3.4. Interfacing with a user-defined solver

An own solver can be specified using the `solver own solvername` command, or selecting User-defined in LS-OPT*ui*. The `solver` command " " can either execute a command, or a script. The substituted input file `UserOpt.inp` will automatically be appended to the command or script. Variable substitution will be performed in the `solver` input file (which will be renamed `UserOpt.inp`) and the `solver` append file. If the own solver does not generate a 'Normal' termination command to standard output, the solver command must execute a script that has as its last statement the command:

```
echo 'N o r m a l'.
```

*Example:*

```
solver own 'Analyzer'  
  solver command ".././run_this_script"  
  solver input file "setup.jou"
```

### 10.3.5. How to run LS-DYNA from LS-OPT using the license server (Windows)

In case you want to use the license server for LS-DYNA, you need to do the following:

1. Go to the "start" menu of the Windows Operating System and follow the steps:
2. Right click on "My Computer"
  - o Choose "Properties"
  - o Click "Advanced" tab
  - o Click "Environment Variables" button
  - o Add the following "User variables":

LSTC_LICENSE	network
LSTC_LICENSE_SERVER	<name of the license server host machine>

The first column above has the variable names and the second column, the variable values, to be filled into the boxes.

You can also start by right-clicking on the "My Computer" icon on your desktop and going through the steps as explained above.

It may be necessary to restart the operating system to initialize the environment variables.

## 10.4. Preprocessors

The preprocessor must be identified as well as the command used for the execution. The command file executed by the preprocessor to generate the input deck must also be specified. The preprocessor specification is valid for the current solver environment.

### Command file syntax:

---

```
prepro software_package_identifier
prepro command "prepro_program_name"
prepro input file "pre_file_name"
```

---

The interfacing of a preprocessor involves the specification of the design variables, input files and the preprocessor run command. Interfacing with LS-INGRID, LS-PREPOST, TrueGrid<sup>9</sup>, AutoDV and HyperMorph<sup>10</sup> and the ANSA Morpher<sup>11</sup> is detailed in this section. The identification of the design variables in the input file is detailed in Section 10.2.

### 10.4.1. LS-PREPOST

The identifier in the prepro section for the use of LS-PREPOST is `lsprepost`. The file `LsPrepostOpt.inp` is created from the LS-PREPOST input template file.

#### Example:

```
solver dyna960 'a'
  solver command "ls971_single"
  solver input file "lspout"
  solver check output on
  solver compress d3plot off
$ ----- Pre-processor -----
prepro lsprepost
prepro command "lspp3"
prepro input file "test01.cfile"
```

#### **test01.cfile:**

```
$# LS-PrePost command file created by LS-PREPOST 3.0(Beta) - 31Mar2010(17:08)
$# Created on Apr-06-2010 (13:42:14)
emptymodel
openc command "para01.cfile"
genselect target node
occfiler clear
genselect clear
genselect target node
```

---

<sup>9</sup>Registered Trademark of XYZ Scientific Applications, Inc.

<sup>10</sup>Registered Trademark of Altair Engineering, Inc.

<sup>11</sup>Registered Trademark of Detroit Engineering Products

```
occfilter clear
genselect clear
meshing boxshell create 0.000000 0.000000 0.000000 &size &size &size &num &num &num
ac
meshing boxshell accept 1 1 1 boxshell
genselect target node
occfilter clear
refcheck modelclean 9
ac
mesh
save keyword "lspout"
exit
```

#### ***para01.cfile***

```
parameter size 1.0
parameter num 2
```

The input allow the execution of LS-PREPOST using the command “`lspp3 c=LsPrepostOpt.inp 2>/dev/null > /dev/null`”. The file `LsPrepostOpt.inp` is created by replacing the parameter values of the variables ‘*size*’ and ‘*num*’ in *para01.cfile* with the relevant values of the design variables.

### **10.4.2. LS-INGRID**

The identifier in the `prepro` section for the use of LS-INGRID is `ingrid`. The file `ingridopt.inp` is created from the LS-INGRID input template file.

#### *Example:*

```
$ the preprocessor software to be used.
prepro ingrid
$ the command to execute the preprocessor
prepro command "ingrid"
$ the input file to be used by the preprocessor
prepro input file "p9i"
```

This will allow the execution of LS-INGRID using the command “`ingrid i=ingridopt.inp -d TTY`”. The file `ingridopt.inp` is created by replacing the `<< name >>` keywords in the `p9i` file with the relevant values of the design variables.

### **10.4.3. TrueGrid**

The identifier in the `prepro` section for the use of TrueGrid is `truegrid`. This will allow the execution of TrueGrid using the command “`prepro program_name i=TruOpt.inp`”. The file `TruOpt.inp` is created by replacing the `<< name >>` keywords in the TrueGrid input template file with the relevant values of the design variables.

#### *Example:*

```
$ the preprocessor software to be used.
prepro truegrid
```



```
$ the command to execute the preprocessor
prepro command "tgx"
$ the input file to be used by the preprocessor
prepro input file "cyl"
```

These lines will execute TrueGrid using the command “`tgx i=cyl`” having replaced all the keyword names `<< name >>` in `cyl` with the relevant values of the design variables.

The TrueGrid input file requires the line:

```
write end
```

at the very end.

#### 10.4.4. ANSA (BETA CAE Systems SA)

The ANSA preprocessor can be interfaced with LS-OPT allowing for shape changes to be specified. The identifier in the `prepro` section for ANSA is `ANSA`. Several files must be specified:

1. *ANSA executable*, typically named *ansa.sh*. Do not use an alias.
2. *ANSA Design parameter file*, typically with the extension *.txt* or *.dat*. This file is generated using ANSA and LS-OPT will read the ANSA design parameter names and values from this file. Parameters defined in the parameter file will become constants with the same name and value in LS-OPT. The user can change them to be design variables instead of constants in the variable panel of the GUI. If LS-OPT already has a design variable with the same name then this variable will be used to drive the value of the ANSA parameter.
3. *ANSA binary database*, typically with the extension *.ansa*.
4. LS-DYNA executable.
5. *LS-DYNA input file*. ANSA automatically produces a LS-DYNA keyword file called *ansaout .* This file will therefore automatically appear as the LS-DYNA input file in the GUI. However this file can also be used as an appended file or include file (specified under `*INCLUDE`). In this case an input file name has to be specified for LS-DYNA.

*Example:*

```
$
$ DEFINITION OF SOLVER "1"
$ Solver "1" uses ANSA
solver dyna '1'
$
prepro ANSA
prepro command "/home/jane/bin/ansa.sh"
prepro input file "model.txt"
propro database file "model.ansa"
$
solver command "lsdyna"
solver input file "ansaout"
$
```

### 10.4.5. AutoDV

The geometric preprocessor AutoDV can be interfaced with LS-OPT which allows shape variables to be specified. The identifier in the `prepro` section for the use of AutoDV is `templex` (the name of an auxiliary product: Templex<sup>12</sup>). The use of AutoDV requires several input files to be available.

1. *Input deck*: At the top, the variables are defined as `DVAR1`, `DVAR2`, etc. along with their current values. The default name is `input.tpl`. This file is specified as the `prepro input file`.
2. *Control nodes file*: This is a nodal template file used by Templex to produce the nodal output file using the current values of the variables. This file is specified using the `prepro controlnodes` command. The default name is `nodes.tpl`.
3. A coefficient file that contains original coordinates and motion vectors specified in two columns must be available. The command used is `prepro coefficient file` and the default file name is `nodes.shp`.
4. Templex produces a nodal output file that is specified under the `solver append file` command. The default name is `nodes.include`.

*Example:*

```
$
$ DEFINITION OF SOLVER "1"
$
solver dyna '1'
  solver command "lsdyna"
  solver append file "nodes.include"
  solver input file "dyna.k"
  prepro templex
  prepro command "/origin_2/user/mytemplex/templex"
  prepro input file "a.tpl"
  prepro coefficient file "a.dynakey.node.tpl"
  prepro controlnodes file "a.shp"
```

In the example, several files can be defaulted.

**Table 10-1: Templex solver and prepro files and defaults**

Command	Description	Default
<code>prepro input file</code>	Templex input file	<code>input.tpl</code>
<code>prepro coefficient file</code>	Coefficient file	<code>nodes.shp</code>
<code>prepro controlnodes file</code>	Control Nodes file	<code>nodes.tpl</code>
<code>solver append file</code>	Append file (same as templex output file)	<code>nodes.include</code>

The `prepro` command will enable LS-OPT to execute the following command in the default case:

<sup>12</sup> Registered Trademark of Altair Engineering, Inc.

```
/origin 2/john/mytemplex/templex input.tpl > nodes.include
```

or if the input file is specified as in the example:

```
/origin 2/user/mytemplex/templex a.tpl > nodes.include
```

*Remarks:*

1. LS-OPT uses the name of the variable on the DVARi line of the input file:0.

```
{DVAR1=23.77}
{DVAR2=49.05}
```

to replace the variables and bounds at the end of each line by the current values. The name DVAR1 (or DVAR2) is recognized by LS-OPT and displayed in the ‘Variables’ panel.

### 10.4.6. HyperMorph

To allow the specification of shape variables, the geometric preprocessor HyperMorph<sup>13</sup> has been interfaced with LS-OPT. The identifier in the `prepro` section for the use of HyperMorph is `hypermorph`.

1. *Input deck:* At the top, the variables are defined as:

```
{parameter(DVAR1, "Radius_1", 1, 0.5, 3.0)}
```

This file is specified as the `prepro` input file.

2. Templex produces a nodal output file that is specified under the `prepro output file` command.

*Example:*

```
$
$ DEFINITION OF SOLVER "1"
$
solver dyna '1'
  solver command "ls970.single"
  solver append file "nodes.include"
  solver input file "dyna.k"
  prepro hypermorph
  prepro command "/origin 2/user/mytemplex/templex"
  prepro input file "a.tpl"
  prepro output file "h.output"
```

**Table 10-2: HyperMorph preprocessor input files and defaults**

Command	Description
---------	-------------

---

<sup>13</sup> Registered Trademark of Altair Engineering, Inc.

prepro input file	Templex input file
prepro output file	Output file produced by Templex (can e.g. be used as an include file in the analysis)

The prepro command will enable LS-OPT to execute the following command in the default case:

```
/origin 2/john/mytemplex/templex input.tpl > nodes.include
```

or if the input file is specified as in the example:

```
/origin 2/user/mytemplex/templex a.tpl > h.output
```

*Remarks:*

1. LS-OPT uses the name of the variable on the DVAR $i$  line of the input file:

```
{parameter(DVAR1, "Radius_1", 1, 0.5, 3.0) }
{parameter(DVAR2, "Radius_2", 1, 0.5, 3.0) }
```

to replace the variables and bounds at the end of each line by the current values. This name, e.g. Radius\_1 is recognized by LS-OPT and automatically displayed in the ‘Variables’ panel. The lower and upper bounds (in this case: [0.5, 3.0]) are also automatically displayed. The DVAR $i$  designation is not changed in any way, so, in general there is no relationship between the number or rank of the variable specified in LS-OPT and the number or rank of the variable as represented by  $i$  in DVAR $i$ .

### 10.4.7. User-defined preprocessor

In its simplest form, the `prepro own` preprocessor can be used in combination with the design point file: `XPoint` to read the design variables from the run directory. Only the `prepro` command statement will therefore be used, and no input file (`prepro input file`) will be specified.

The user-defined `prepro` command will be executed with the standard preprocessor input file `UserPreproOpt.inp` appended to the command. The `UserPreproOpt.inp` file is generated after performing the substitutions in the `prepro input file` specified by the user.

*Example:*

```
prepro own
prepro command "gambit -r1.3 -id ../../casefile -in "
prepro input file "setup.jou"
```

The executed command is:

```
gambit -r1.3 -id ../../casefile -in setup.jou
```

Alternatively, a script can be executed with the `prepro` command to perform any number of command line commands that result in the generation of a file called: `UserOpt.inp` for use by an own solver, or `DynaOpt.inp` for use by LS-DYNA.

## 10.5. Postprocessors

A postprocessor can be scheduled to run immediately after the completion of simulations, but before extracting the data. The postprocessor allows extraction of data from any database it supports, so makes LS-OPT accessible to interface with any such supported solvers. LS-OPT launches the post-processor in each run directory, e.g. *Case\_A/1.1*. This allows the postprocessor to read results from the solver database and place them in a simple text file or files for individual extraction of results. The types of processors supported are (1)  $\mu$ ETA<sup>14</sup>. The post-processor commands are as follows.

### Command file syntax:

---

```
postpro <postprocessor_package>
postpro command "run_command"
postpro database file "database_file_name"
postpro input file "input_file_name"
postpro output file "output_file_name"
```

---

#### Example:

```
postpro metapost
postpro command ".././metap"
postpro input file ".././sessionfile.txt"
postpro output file "./Results.txt"
postpro database file "./"
```

#### Remarks:

1. The run command launches the postprocessor.
2. The input file name contains information about which results to extract. For commercial postprocessors, this is typically a session file which was created interactively.
3. The database file name is the name of the solver database to be parsed or read for results. Because the database information may have been specified in the session file, some post-processors (e.g.  $\mu$ ETA) may only require a path for finding the database.
4. The output file (result file) is the name of a file containing those results requested in the input (session) file. This is usually a text file so it can be easily parsed. For those postprocessors supported by LS-OPT, this file has a predetermined format so that LS-OPT can automatically extract the individual results. The specified path + name is not used during the optimization run, but only during the setup phase while the user is preparing the LS-OPT input data. During this phase, the responses are parsed from a baseline result file and automatically displayed in the "Histories" and "Responses" pages of the GUI.

---

<sup>14</sup> BETA CAE Systems S.A.

5. In the case of user-defined post-processor, the full command needs to be provided. In this case, LS-OPT does not internally construct the command using the input, database and result files.

The supported post-processors are discussed in more detail as follows:

### 10.5.1. $\mu$ ETA (BETA CAE Systems SA)

The full  $\mu$ ETA run command executed by LS-OPT is:

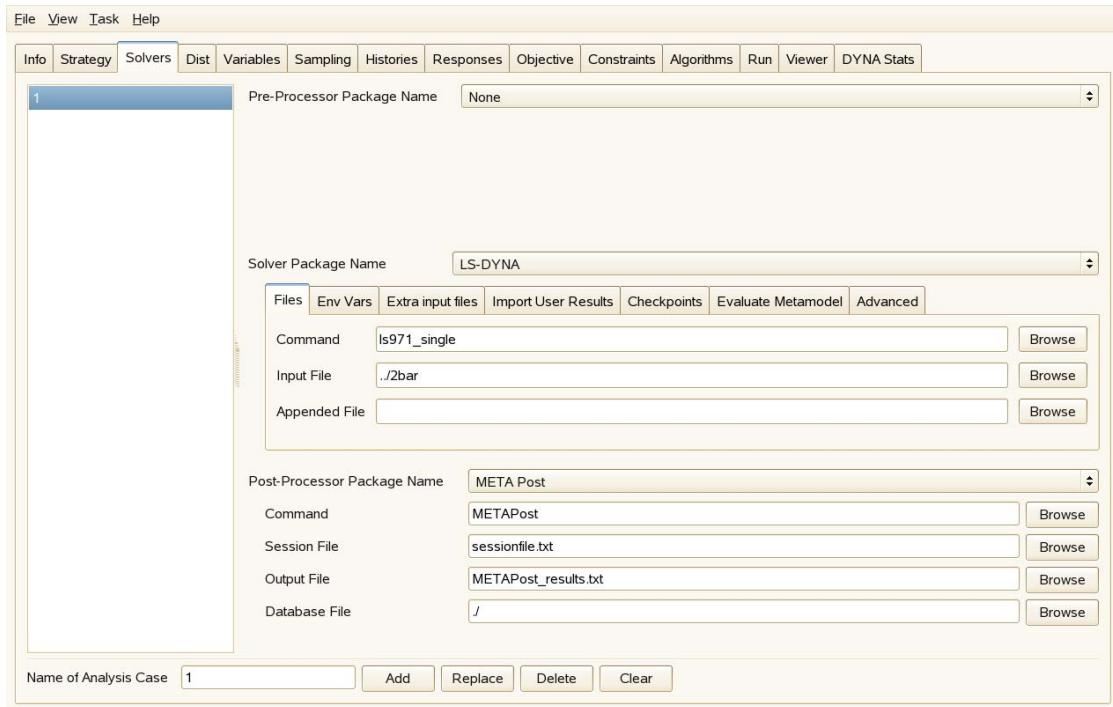
```
<metapost_executable> -b -s -foregr <path/sessionfile> "<database_path>"  
"<path/result_file>"
```

where the arguments to be specified as LS-OPT input have the following meanings:

1. `metapost_executable`. The  $\mu$ ETA executable specified in the postprocessor command.
2. `path/sessionfile`. This is the session file name.
3. `path/result_file`. This specification is only used for parsing the history and response names (to be automatically displayed in the GUI) during the LS-OPT setup phase (see below).
4. `database_path`. This is the path for finding the solver database. The default `"/"` means that  $\mu$ ETA will look for the database locally. This specification has no effect during the optimization run as LS-OPT will always force  $\mu$ ETA to look for the solver database locally, e.g. in the run directory *Case\_A/1.1*.

Setting up an LS-OPT problem:

1. Run  $\mu$ ETA and use the session file thus created to create the result file. This is done manually, separately from the LS-OPT data preparation (an integrated feature might be provided in the future).
2. Open the LS-OPT GUI on the *Solvers* page and select METAPost as the Postprocessor package name.
3. Specify the  $\mu$ ETA settings in the LS-OPT GUI (see Figure 10-2). The user can browse for the  $\mu$ ETA executable, session file and result file. The result file is the one that was created in the manual step (Step 1. above). The database path need not be changed.
4. When exiting the "Solvers" page in the GUI, the result file is parsed for history and response names to display in the relevant GUI pages. These can then be used to complete the optimization problem setup: define composites, objectives and constraints, etc.
5. After completion of the optimization setup, run LS-OPT.



*Figure 10-2: Solvers panel showing Post-processor feature*

## 10.5.2. User-defined post-processor

This feature enables one to execute any type of post-processor by providing the full post-processor command. The output file needs to be written in the same format as for the  $\mu$ ETA package. The format is as follows:

```
#
RESPONSES
0, Weight, 0.591949043101576
1, StressL, 3.74281176328897
2, StressR, 1.99975762786926
END
#
HISTORY 99 : his1
0,0
0.0795849328001081,0.23516125192977
0.159169865600216,0.274354793918065
0.238754798400324,0.31354833590636
0.318339731200433,0.352741877894655
0.397924664000541,0.39193541988295
#
END
#
RESPONSES
END
#
HISTORY 100 : his2
0,0
0.0795849328001081,0.627096671812721
```

```
0.159169865600216,0.666290213801015
0.238754798400324,0.705483755789311
0.318339731200433,0.744677297777606
0.397924664000541,0.783870839765901
#
END
```

Setting up an LS-OPT problem is similar to  $\mu$ ETA, except that **User-defined** is selected as the post-processor package on the “Solvers” page, and the session file and database path need not be provided as the related information is available in the command file.

*Example :*

```
postpro userpost
postpro command ".././fullcommandscript"
postpro output file "./Results.txt"
```

It is also possible to run  $\mu$ ETA as a user-defined post-processor. In this case, the command provided in “fullcommandscript” is:

```
<metapost_executable> -b -s -foregr <path/sessionfile> "<database_path>"
"<path/result_file>"
```

Unlike in the case of  $\mu$ ETA, the full command is not constructed internally by LS-OPT. Therefore, `metapost_executable`, `path/sessionfile`, `database_path`, and `path/result_file` need to be provided in `fullcommandscript`. Because all the information is available in the command, it is not necessary to provide the input and database files separately in this case.

The output file name must however be specified for the following reason. When exiting the "Solvers" page in the GUI, the output file is parsed for history and response names to import and display in the relevant GUI pages. These can then be used to complete the optimization problem setup: define composites, objectives and constraints, etc.

## 10.6. Extra input files

A list of extra input files can be provided for the preprocessor or solver. A different set can be specified for each analysis case. The files can be placed in any directory and are copied to the run directories before the start of the preprocessing. Parameters can be specified in the extra files using the native format (e.g. \*PARAMETER for LS-DYNA) or the generic LS-OPT format (<<parameter>>) (see Section 10.2.1).

Note that LS-DYNA include files do not have to be specified as extra files, since these are automatically processed. However, if the user has parameters in include files with a relative (e.g. MyFiles/geometry.inc) or absolute path (\home\jo\LSOPT\MyFiles\Material59.inc), these include files must be specified as extra input files in order to force copying to the run directory.

The \*INCLUDE specification pertaining to extra files should not include the path specification since the files have been copied to the run directory where the main file is residing. Files copied to the run directory are also processed by the wrapper for running on a remote machine.

LS-OPT will automatically parse the extra input files for variable names and list them on the **Variables** page as constants. The user can then change them to variables.



The files are specified in the GUI under the “Solvers” tab (“Extra files” sub-tab).

**Command file syntax:**

---

```
Solver extra file "extra_file_name"
```

---

**Example:**

```
solver extra file "inputfile1.txt"  
solver extra file "inputfile2.txt"  
solver extra file "inputfile3.txt"
```

# 11. Design Variables, Constants, and Dependents

This chapter describes the definition of the input variables, constants and dependents, design space and the initial subregion.

All the items in this chapter are specified in the Variables panel in LS-OPT<sub>ui</sub> (Figure 11-1). Shown is a multidisciplinary design optimization (MDO) case where not all the variables are shared, e.g., `shotgun_outer` in Figure 11-1 is only associated with the solver CRASH.

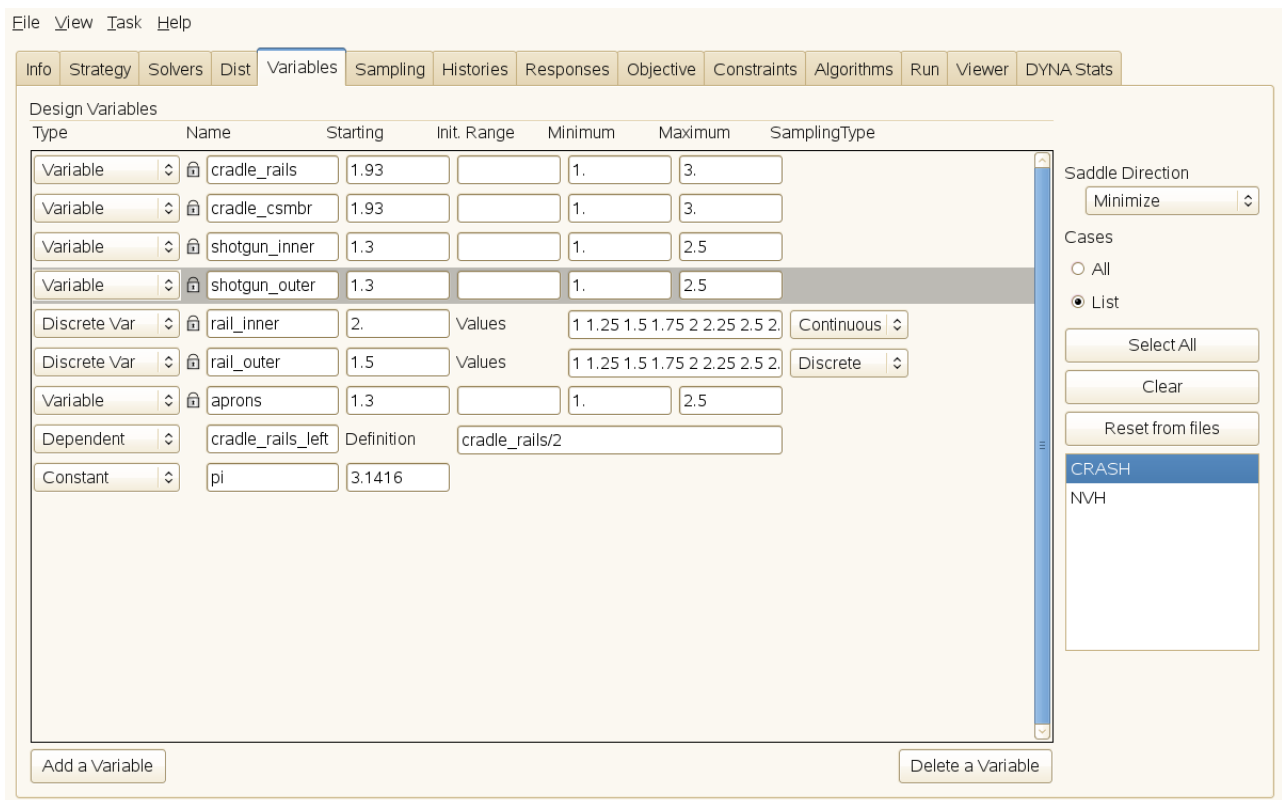


Figure 11-1: Variables panel in LS-OPT<sub>ui</sub>

## 11.1. Selection of design variables

The `variable` command is the identification command for each variable.

### Command file syntax:

---

```
variable variable_name value
```

---

#### Example:

```
$ DEFINE THE VARIABLE: 'Area'  
Variable 'Area' 0.8
```

The value assigned is the initial value of the variable.

## 11.2. Definition of upper and lower bounds of the design space

### Command file syntax:

---

```
Lower bound variable variable_name value <-10+30>  
Upper bound variable variable_name value <+10+30>
```

---

#### Example:

```
Lower bound variable 'Area' 0.1  
Upper bound variable 'Area' 2.0
```

Both the lower and upper bounds must be specified, as they are used for scaling.

## 11.3. Size and location of region of interest (range)

### Command file syntax:

---

```
range variable_name subregion_size
```

---

#### Example:

```
$ RANGE OF 'Area'  
range 'Area' 0.4
```

This will allow 'Area' to vary from 0.6 to 1.0.

#### Remarks:

1. A value of 25-50% of the design space can be chosen if the user is unsure of a suitable value.
2. The full design space is used if the range is omitted.

3. The region of interest is centered on a given design and is used as a sub-space of the design space to define the experimental design. If the region of interest protrudes beyond the design space, it is moved without contraction to a location flush with the design space boundary.

## 11.4. Local variables

For multidisciplinary design optimization (MDO) certain variables are assigned to some but not all solvers (disciplines). In the command file the following syntax defines the variable as local:

### Command file syntax:

---

```
local variable_name
```

---

See Section 22.6 for an example.

## 11.5. Discrete variables

Discrete variables are defined using (i) a name, (ii) a starting value, (iii) a list of allowable values, and (iv) the choice to sample the variable as discrete or continuous. Specifying an initial range for the construction of a response surface is optional; the allowable values will be used to compute a default range. By default, the discrete variables are treated as continuous variables for generating experimental designs. The following commands are therefore required to define a discrete variable:

### Command file syntax:

---

```
variable variable_name value  
variable variable_name discrete {discrete_value_1 ...  
discrete_value_n}
```

---

#### *Example:*

```
variable 'Area' 3.1  
variable 'Area' discrete {2.0 3.1 4.0 5}
```

The following command is used to sample the variable as discrete:

```
variable 'Area' use discrete
```

## 11.6. Assigning variable to solver

If a variable has been flagged as local, it needs to be assigned to a solver. The command file syntax is:

**Command file syntax:**

---

```
Solver variable variable_name
```

---

See Section 22.6 for an example.

## 11.7. Constants

Each variable above can be modified to be a constant. See Figure 11-1 where a user defined value of the constant `pi` is provided.

Constants are used:

1. to define constant values in the input file such as  $\pi$ ,  $e$  or any other constant that may relate to the optimization problem, e.g. initial velocity, event time, integration limits, etc.
2. to convert a variable to a constant. This requires only changing the designation variable to constant in the command file without having to modify the input template. The number of optimization variables is thus reduced without interfering with the template files.

**Command file syntax:**

---

```
constant constant_name value
```

---

*Example:*

```
constant 'Youngs_modulus' 2.07e8  
constant 'Poisson_ratio' 0.3  
dependent 'Shear_modulus' {Youngs_modulus/(2*(1 + Poisson_ratio))}
```

In this case, the dependent is of course not a variable, but a constant as well.

## 11.8. Dependent variables

Dependent variables (see Figure 11-1 for example of definition in Variables panel) are functions of the basic variables and are required to define quantities that have to be replaced in the input template files, but which are dependent on the optimization variables. They do therefore not contribute to the size of the optimization problem. Dependents can be functions of dependents.

Dependent variables are specified using mathematical expressions (see Appendix D).

**Command file syntax:**

---

```
dependent variable_name expression
```

---

The string must conform to the rules for expressions and be placed in curly brackets. The dependent variables can be specified in an input template and will therefore be replaced by their actual values.

*Example:*

```
variable 'Youngs_modulus' 2.0e08
variable 'Poisson_ratio' 0.3
dependent 'Shear_modulus' {Youngs_modulus/(2*(1 + Poisson_ratio))}
```

## 11.9. System variables

System variables are internal LS-OPT variables. There are two system variables, namely `iterid` and `runid`. `iterid` represents the iteration number while `runid` represents the run number within an iteration. Hence the name of a run directory can be represented by: `iterid.runid`. System variables are useful for using files such as postprocessing files that were already created in an earlier case, but which are re-used in the current case. An LS-DYNA example of using system variables is as follows:

```
*INCLUDE
../../../../Case1/⟨⟨iterid:i0⟩⟩.⟨⟨runid:i0⟩⟩/frontrail.k
```

After substitution the second line might become:

```
../../../../Case1/1.13/frontrail.k
```

so that the current case will always include the file in the corresponding directory in Case1.

The `i0` format forces an integer specification (see Section 10.2.1 for a more detailed description). Unfortunately the feature cannot be used with LS-DYNA `*PARAMETER` parameters.

## 11.10. Worst-case design

Worst-case or saddle-point design is where the objective function is minimized (or maximized) with respect to *some* variables, while it is maximized (or minimized) with respect to the *remaining* variables in the variable set. The maximization variables are set using the Maximize option in the Saddle Direction field of the Variables panel. The default selection is Minimize.

**Command file syntax:**

---

```
Variable variable_name max
```

---

*Example:*

```
variable 'head_orientation' max
```

# 12. Probabilistic Modeling and Monte Carlo Simulation

Probabilistic evaluations investigate the effects of variations of the system parameters on the system responses.

The variation of the system parameters is described using variables and probabilistic distributions describing their variation. Accordingly, the variation of the system responses, including information such as the nominal value of the response, reliability, and extreme values, can be computed. The source of the variation can be the variation of the design variables (control variables) as well as the variation of noise variables, whose value is not under the control of the analyst such as the variation in a load.

More background on the probabilistic methods is given in Chapter 6 (the theoretical manual), while example problems can be found in Chapter 22.

## 12.1. Probabilistic problem modeling

Introducing the probabilistic effects into analysis requires the specification of:

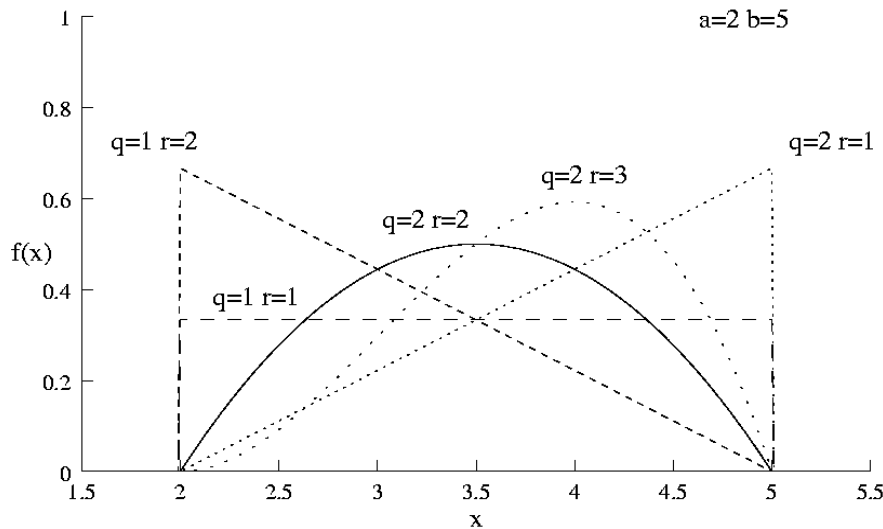
1. Statistical distributions
2. Assigning the statistical distributions to design variables
3. Specification of the experimental design. For a Monte Carlo analysis, a suitable strategy for selecting the experimental points must be specified; for example, a Latin Hypercube experimental design can be used to minimize the number of runs required to approximate the mean and standard deviation. However, if the Monte Carlo analysis is done using a metamodel, then the experimental design pertains to the construction of the metamodel
4. The probabilistic analysis to be executed; for example, a Monte Carlo reliability analysis.

## 12.2. Probabilistic distributions

The probabilistic component of a design variable is described using a probabilistic distribution. The distributions are created without referring to a variable. Many design variables can refer to a single distribution.

### 12.2.1. Beta distribution

The beta distribution is quite versatile as well as bounded by two limits:  $a$  and  $b$ . The shape of the distribution is described by two parameters:  $q$  and  $r$ . Swapping the values of  $q$  and  $r$  produces a mirror image of the distribution.



*Figure 12-1 Beta distribution*

#### Command file syntax:

---

```
distribution 'name' BETA a b q r
```

---

Item	Description
<i>name</i>	<b>Distribution name</b>
<i>a</i>	Lower Bound
<i>b</i>	Upper Bound
<i>q</i>	Shape parameter q
<i>r</i>	Shape parameter r

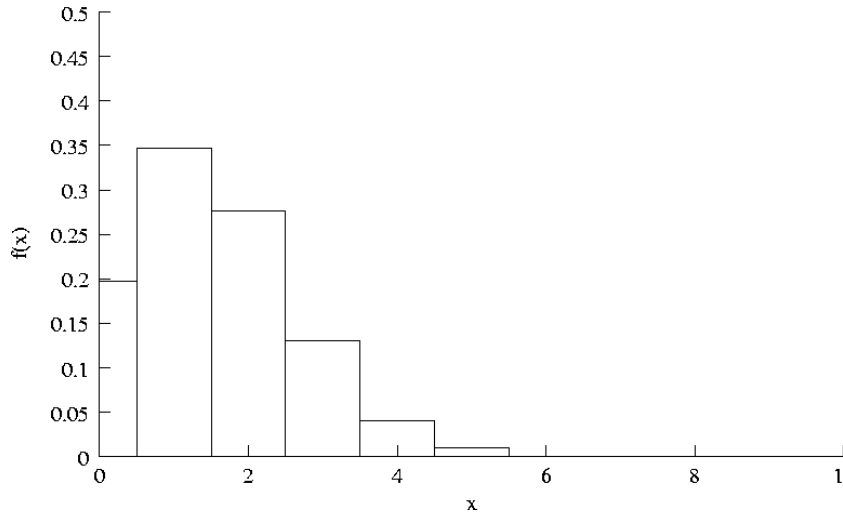
#### Example:

```
distribution 'distBeta' BETA 2.0 5.0 1.0 1.0
```



### 12.2.2. Binomial distribution

The binomial distribution is a discrete distribution describing the expected number of events for an event with probability  $p$  evaluated over  $n$  trials. For  $n=1$ , it is the Bernoulli distribution (experiments with two possible outcomes — success or failure) with probability of success  $p$ .



*Figure 12-2 Binomial distribution*

#### Command file syntax:

---

```
distribution 'name' BINOMIAL p n
```

---

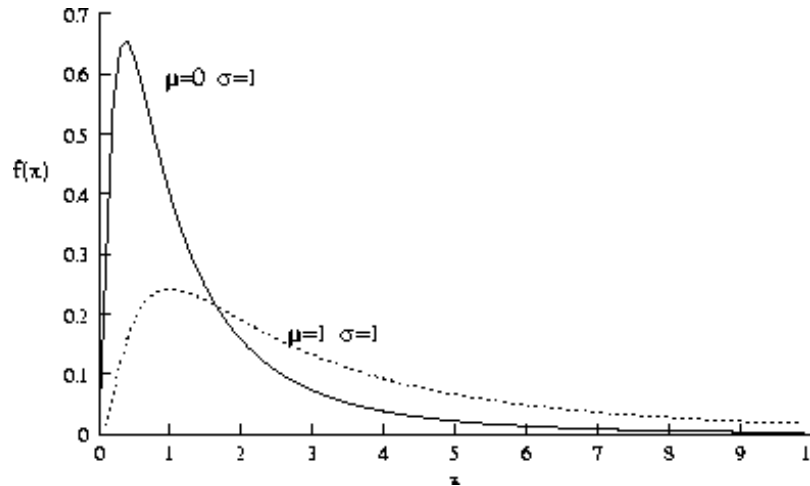
Item	Description
<i>name</i>	<b>Distribution name</b>
<i>p</i>	Probability of event (Success)
<i>n</i>	Number of trials

*Example:*

```
distribution 'distBin' BINOMIAL 0.1 3
```

### 12.2.3. Lognormal distribution

If  $X$  is a lognormal random variable with parameters  $\mu$  and  $\sigma$ , the random variable  $Y = \ln X$  has a normal distribution with mean  $\mu$  and variance  $\sigma^2$ .



*Figure 12-3 Lognormal distribution*

**Command file syntax:**

---

```
distribution 'name' LOGNORMAL mu sigma
```

---

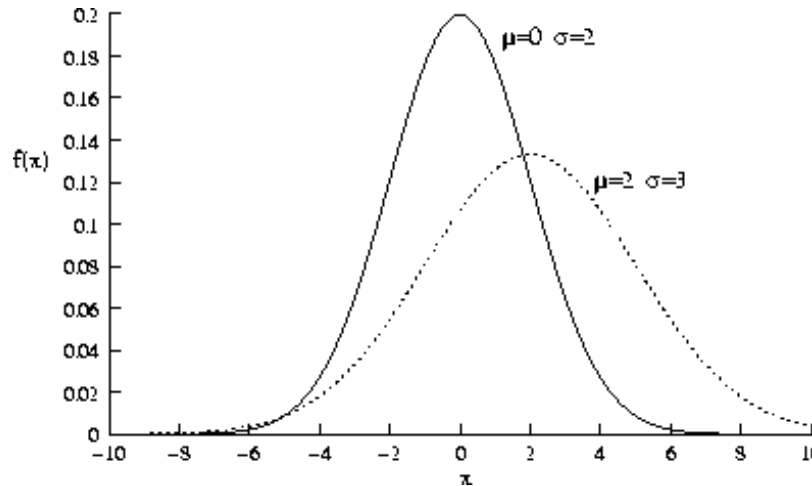
Item	Description
<i>name</i>	<b>Distribution name</b>
<i>mu</i>	Mean value in logarithmic domain
<i>sigma</i>	Standard deviation in logarithmic domain

*Example:*

```
distribution 'logDist' LOGNORMAL 12.3 1.1
```

### 12.2.4. Normal distribution

The normal distribution is symmetric and centered about the mean  $\mu$  with a standard deviation of  $\sigma$ .



*Figure 12-4 Normal Distribution*

**Command file syntax:**

---

```
distribution 'name' NORMAL mu sigma
```

---

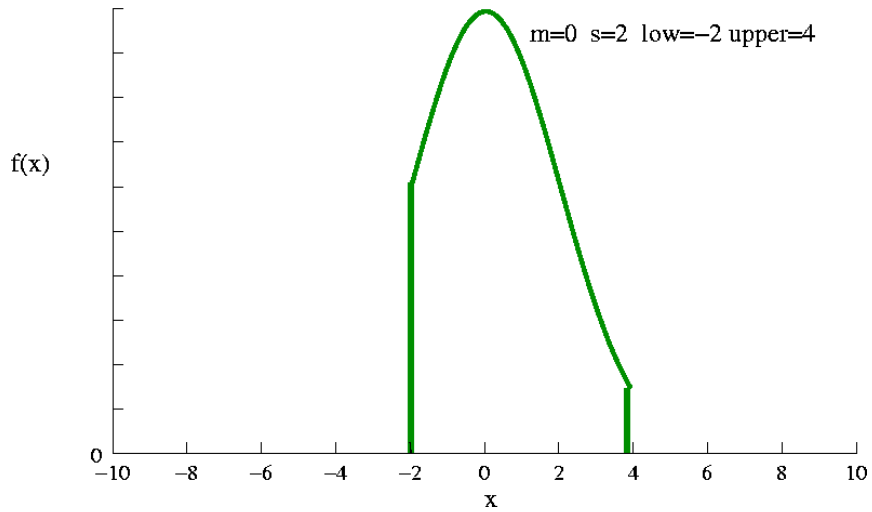
Item	Description
<i>name</i>	<b>Distribution name</b>
<i>mu</i>	<b>Mean value</b>
<i>sigma</i>	Standard deviation

*Example:*

```
distribution 'normalDist' NORMAL 12.2 1.1
```

### 12.2.5. Truncated normal distribution

The truncated normal distribution is a normal distribution with the values constrained to be within a lower and an upper bound. This distribution occurs when the tails of the distribution are censored through, for example, quality control.



*Figure 12-5 Truncated Normal Distribution*

**Command file syntax:**

---

```
distribution 'name' TRUNCATED_NORMAL mu sigma low upper
```

---

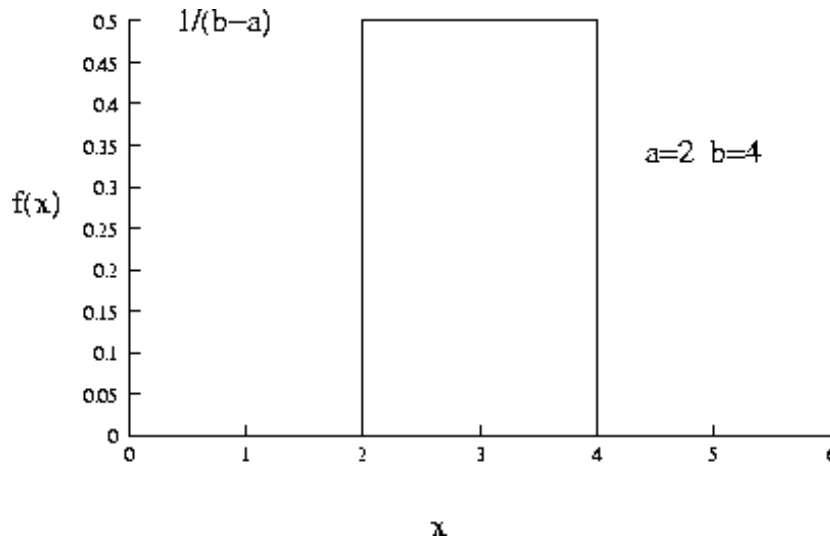
Item	Description
<i>name</i>	<b>Distribution name</b>
<i>mu</i>	<b>Mean value</b>
<i>sigma</i>	Standard deviation
<i>low</i>	Lower bound on values
<i>upper</i>	Upper bound on values

*Example:*

```
distribution 'truncNormalDist' TRUNCATED_NORMAL 12.2 1.1 10.0 12.0
```

### 12.2.6. Uniform distribution

The uniform distribution has a constant value over a given range.



**Figure 12-6 Uniform Distribution**

**Command file syntax:**

---

```
distribution 'name' UNIFORM lower upper
```

---

Item	Description
<i>name</i>	Distribution name
<i>lower</i>	Lower bound
<i>upper</i>	Upper bound

*Example:*

```
distribution 'rangeX' UNIFORM 1.2 3.4
```

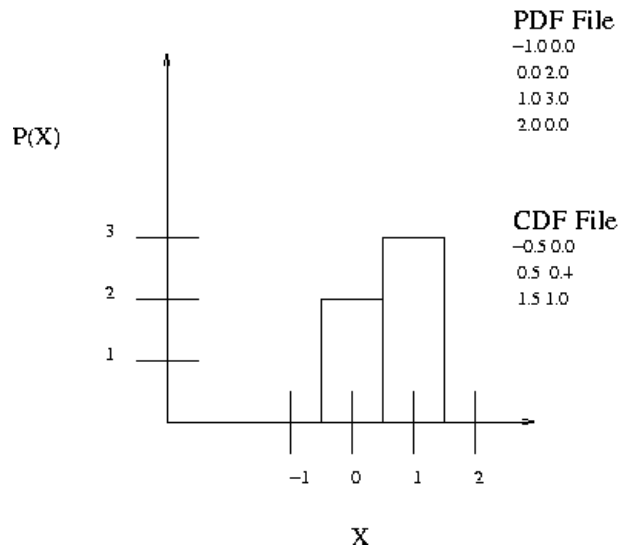
### 12.2.7. User defined distribution

A user-defined distribution is specified by referring to the file containing the distribution data.

The probability density is to be assumed piecewise uniform and the cumulative distribution to be piecewise linear. Either the PDF or the CDF data can be given:

- **PDF distribution:** The value of the distribution and the probability at this value must be provided for a given number of points along the distribution. The probability density is assumed to be piecewise uniform at this value to halfway to the next value; both the first and last probability must be zero.

- **CDF distribution:** The value of the distribution and the cumulative probability at this value must be provided for a given number of points along the distribution. It is assumed to vary piecewise linearly. The first and last value in the file must be 0.0 and 1.0 respectively.



**Figure 12-7 User defined distribution**

Lines in the data file starting with the character ‘\$’ will be ignored.

**Command file syntax:**

---

```
distribution 'name' USER_DEFINED_PDF "fileName"
distribution 'name' USER_DEFINED_CDF "fileName"
```

---

Item	Description
<i>name</i>	<b>Distribution name</b>
<i>filename</i>	<b>Name of file containing the distribution data</b>

*Example:*

```
distribution 'bendDist' USER_DEFINED_PDF "bendingTest.pdf"
distribution 'testDat' USER_DEFINED_CDF "threePointTest.dat"
```

The file “bendingTest.pdf” contains:

```
$ Demonstration of user defined distribution with
$ piecewise uniform PDF values
$ x PDF
$ First PDF value must be 0
-5          0.00000
-2.5       0.11594
```

```

0          0.14493
2.5       0.11594
$ Last PDF value must be 0
5         0.00000
    
```

The file “threePointTest.dat” contains:

```

$ Demonstration of user defined distribution with
$ piecewise linear CDF values
$ x CDF
$ First CDF value must be 0
-5         0.00000
-4.5      0.02174
-3.5      0.09420
-2.5      0.20290
-1.5      0.32609
-0.5      0.46377
0.5       0.60870
1.5       0.73913
2.5       0.85507
3.5       0.94928
$ Last CDF value must be 1
4.5       1.00000
    
```

### 12.2.8. Weibull distribution

The Weibull distribution is quite versatile – it has the ability to take on various shapes. The probability density function is skewed to the right, especially for low values of the shape parameter.

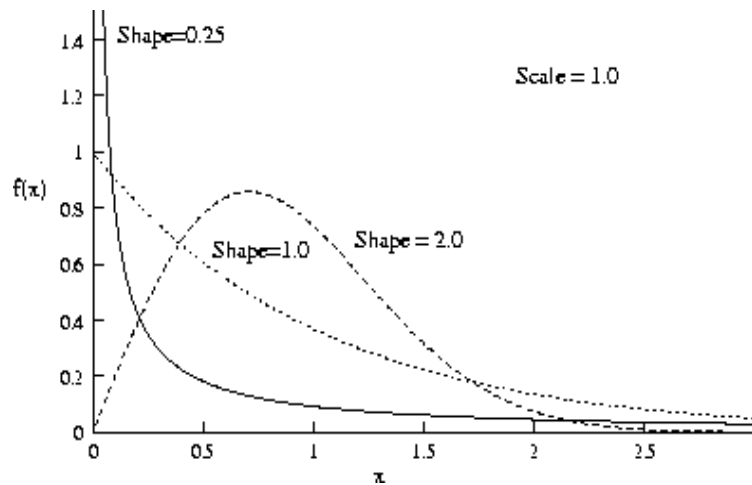


Figure 12-8 Weibull distribution

#### Command file syntax:

---

```
distribution 'name' WEIBULL scale shape
```

---

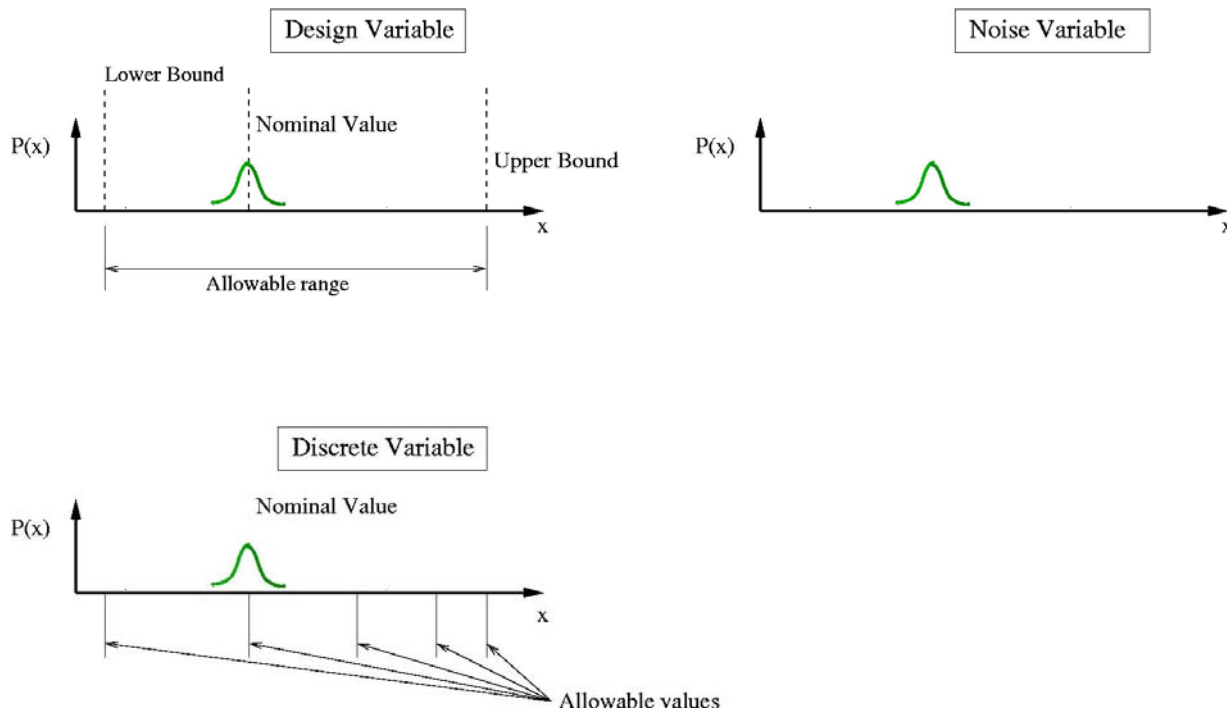
Item	Description
<i>name</i>	<b>Distribution name</b>
<i>scale</i>	Scale parameter
<i>shape</i>	Shape parameter

Example:

```
distribution 'wDist' WEIBULL 2.3 3.1
```

### 12.3. Probabilistic variables

A probabilistic variable is completely described using a statistical distribution. The statistical distribution defines the mean or nominal value as well as the variation around this nominal value. Note that some special rules apply to control variables, the mean of which can be adjusted by the optimization algorithm.



**Figure 12-9 Probabilistic variables.** The nominal value of a control variable can be adjusted by the optimization algorithm between the lower and upper bound; the probabilistic variation of a design variable is around this nominal value. A noise variable is described completely by the statistical distribution. A discrete variable, like design variable has a nominal value selected by the optimization algorithm; the probabilistic variation of the discrete variable is around this nominal value.

A distinction is made between control and noise variables:

- **Control variables:** Variables that can be controlled in the design, analysis, and production level; for example: a shell thickness. It can therefore be assigned a nominal value and will have a variation



around this nominal value. The nominal value can be adjusted during the design phase in order to have a more suitable design. A discrete variable is a special case of a control variable.

- **Noise variables:** Variables that are difficult or impossible to control at the design and production level, but can be controlled at the analysis level; for example: loads and material variation. A noise variable will have the nominal value as specified by the distribution, that is follow the distribution exactly.

A variable is declared probabilistic by:

1. Creating it as a noise variable or
2. Assigning a distribution to a control variable or
3. Creating it as linked to an existing probabilistic variable.

Three associations between probabilistic variables are possible:

1. Their nominal values are the same but their distributions differ
2. Their nominal values and distributions are the same
3. Their nominal values differ, but they refer to the same distribution.

**Command file syntax:**

---

```
noise variable 'variableName' distribution 'distributionName'
variable 'variableName' distribution 'distributionName'
variable 'variableName' link variable 'variableName'
```

---

Item	Description
<i>variableName</i>	Variable identifier
<i>distributionName</i>	Distribution identifier

*Example:*

```
$ Create a noise variable
Noise Variable 'windLoadScatter' distribution 'windLoadData'
$ Assigning a distribution to an existing control variable
Variable 'Var-D-1' Distribution 'dist-1'
$ Creating a variable by linking it to another.
Variable 'Var-D-2' Link variable 'Var-D-1'
```

**12.3.1. Setting the nominal value of a probabilistic variable**

If no nominal value is specified for a control variable, then the nominal value of the distribution is used.

If the nominal value of a control variable is specified, then this value is used; the associated distribution will be used to describe the variation around this nominal value. For example: a variable with a nominal value of 7 is assigned a normal distribution with  $\mu=0$  and  $\sigma=2$ ; the results values of the variable will be normally distributed around a nominal value of 7 with a standard deviation of 2.

This behavior is only applicable to control variables; noise variables will always follow the specified distribution exactly.

### 12.3.2. Bounds on probabilistic variable values

Assigning a distribution to a control value may result in designs exceeding the bounds on the control variables. The default is not to enforce the bounds. The user can control this behavior.

A noise variable is bounded by the distribution specified and does not have upper and lower bounds similar to control variables. However, bounds are required for the construction of the approximating functions and are chosen as described in the next subsection.

#### Command file syntax:

---

```
set variable distribution bound state
```

---

Item	Description
<i>state</i>	Whether the bounds must be enforced for the probabilistic component of the variable.

#### Example:

```
$ ignore bounds on control variables  
set variable distribution bound 0  
$ Respect bounds on control variables  
set variable distribution bound 1
```

### 12.3.3. Noise variable subregion size

Bounds are required for noise variables to construct the metamodels. The bounds are taken to a number of standard deviations away from the mean; the default being two standard deviations of the distribution. The number of standard deviations can be set by the user. In general, a noise variable is bounded by the distribution specified and does not have upper and lower bounds similar to control variables.

#### Command file syntax:

---

```
set noise variable range standardDeviations
```

---

Item	Description
<i>standardDeviations</i>	The subregion size in standard deviations for the noise variable.

*Example:*

```
$ Set noise var bounds to 1.5 standard deviations
$ for defining subregion for creating approximation
set noise variable range 1.5
```

### 12.3.4. Correlated variables

The correlation between variables can be specified. This correlation will be considered in Monte Carlo simulation (including metamodel based simulations) as well as in reliability based design optimization. Only correlation between normally distributed variables is allowed.

**Command file syntax:**

---

```
variable 'vname1' correlated variable 'vname2' corr_value
```

---

Item	Description
<i>corr_value</i>	Value of the correlation between the variables.

*Example:*

```
$ Set the correlation between x1 and x2 as -0.5
Variable 'x1' correlation 'x2' -0.5
```

## 12.4. Probabilistic simulation

The following simulation methods are provided:

- Monte Carlo
- Monte Carlo using metamodels.

The upper and lower bounds on constraints will be used as failure values for the reliability computations.

### 12.4.1. Monte Carlo analysis

The Monte Carlo evaluation will:

- Select the random sample points according to a user specified strategy and the statistical distributions assigned to the variables.
- Evaluate the structural behavior at each point.
- Collect the statistics of the responses.

The user must specify the experimental design strategy (sampling strategy) to be used in the Monte Carlo evaluation. The Monte Carlo, Latin Hypercube and space-filling experimental designs are available. The experimental design will first be computed in a normalized, uniformly distributed design space and then transformed to the distributions specified for the design variables.

Only variables with a statistical distribution will be perturbed; all other variables will be considered at their nominal value.

The following will be computed for all responses:

- Statistics such as the mean and standard deviation for all responses and constraints
- Reliability information regarding all constraints:
- The number of times a specific constraint was violated during the simulation
- The probability of violating the bounds and the confidence region of the probability
- A reliability analysis for each constraint assuming a normal distribution of the response.

The exact value at each point will be used. Sampling schemes must be duplicated across disciplines if composite functions must be computed for each point, because if the experimental designs differ across disciplines, then composite functions referring to responses in more than one discipline can not be computed.

**Command file syntax:**

---

```
analyze Monte Carlo
```

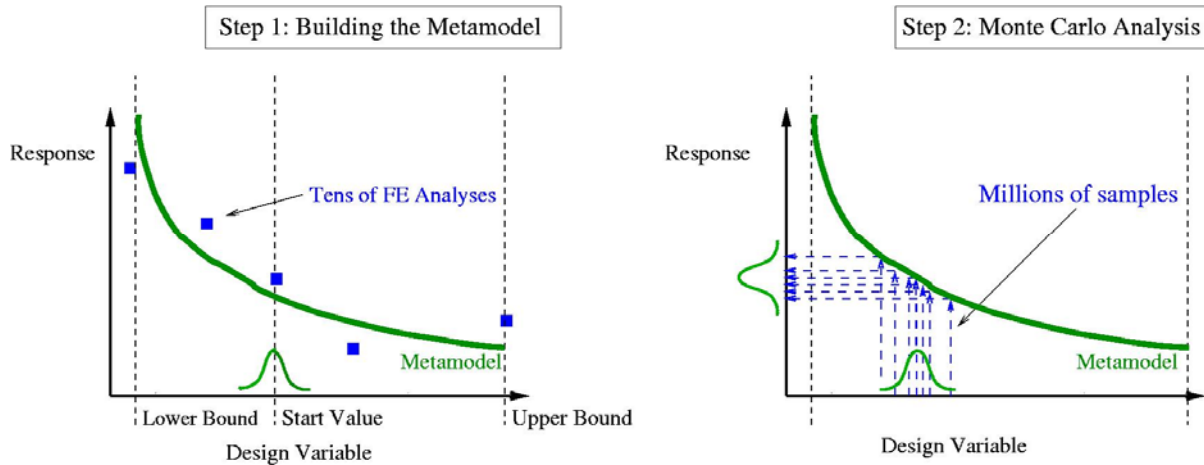
---

*Example:*

```
analyze Monte Carlo
```

### **12.4.2. Monte Carlo analysis using a metamodel**

The Monte Carlo analysis will be done using the metamodels – response surfaces, neural networks, or Kriging – as prescribed by the user.



**Figure 12-10 Metamodel-based Monte Carlo analysis.** The method proceed in two steps: firstly a metamodel is created, and then the Monte Carlo simulation is done using the metamodel and the statistical distribution of the variable. Note that the metamodel for a design/control variable is constructed considering the upper and lower bound on the variable and not considering the statistical distribution. For a noise variable the upper and lower bounds for the creation of the metamodel are selected considering the statistical distribution.

The number of function evaluations can be set by the user. The default value is  $10^6$ . The function evaluations are done using designs chosen randomly respecting the distributions of the design variables and are evaluated using the metamodels.

The following data will be collected:

- Statistics such as the mean and standard deviation for all responses, constraints, and variables
- The reliability information for each constraint:
- The number of times a specific constraint was violated during the simulation
- The probability of violating the bounds and the confidence region of the probability.

#### Command file syntax:

---

```
analyze metamodel monte carlo
```

---

*Example:*

```
analyze metamodel monte carlo
```

#### 12.4.3. Accuracy of metamodel based Monte Carlo

The number of function evaluations to be analyzed can be set by the user. The default value is  $10^6$ .

**Command file syntax:**


---

```
set reliability resolution m
```

---

Item	Description
<i>m</i>	Number of sample values

*Example:*

```
set reliability resolution 1000
```

**12.4.4. Adding the noise component to metamodel Monte Carlo computations**

If noise was found when the metamodel was created, then this noise may be reproduced whenever the metamodel is used for reliability computations. This is possible only for the response surfaces and neural nets. The noise is normally distributed with a zero mean and a standard deviation computed from the residuals of the least square fit. The default is not to add the noise to the computations.

**Command file syntax:**


---

```
set metamodel noise true false
```

---

Item	Description
<i>true false</i>	0 for not adding noise; 1 otherwise

*Example:*

```
set metamodel noise 0 $ default: noise not added in computation
set metamodel noise 1 $ noise included in computation
```

**12.4.5. FORM (First Order Reliability Method) analysis**

A FORM evaluation will:

- Construct the metamodels – response surfaces, neural networks, or Kriging – as prescribed by the user. If the metamodels already exists, then they won't be recreated.
- Conduct a FORM analysis for every constraint using the metamodels.

The following are computed in a FORM analysis:

- The most probable point (see Section 6.4.6)
- The probabilities of exceeding the bounds on the constraint

- The derivatives of the probability of exceeding the bound on the constraint with respect to the design variables

The method requires very little information additionally to what is required for deterministic optimization. Specify the following:

1. Statistical distributions associated with the design variables
2. Probabilistic bounds on the constraints.

Theoretical concerns are discussed in Section 6.4.7. See also Section 19.3 for more information about Reliability Based Design Optimization (RBDO).

**Command file syntax:**

---

```
analyze metamodel FORM
```

---

*Example:*

```
analyze metamodel FORM
```

## 12.5. Stochastic contribution analysis (DSA)

It can be useful to know how the variation of each design variable contributes to the variation of a response. These computations are also known as Stochastic Sensitivity Analysis or Sobol's analysis.

The stochastic contribution will be printed for all the responses in a metamodel-based procedure. If no metamodel is available the covariance of the responses with the variables can be investigated. The stochastic contributions of the variables can also be examined in the Viewer component of the GUI.

The amount of variation due to noise or the residuals from the fitting procedure will be indicated. This term is taken as zero for composite functions.

The stochastic contribution is computed analytically for response surfaces. For neural networks, Kriging models, and composite functions, two options are available:

1. Approximate using second order response surface. The response surface is built using three times the number of terms in the response surface using a central point Latin hypercube experimental design over a range of plus/minus two standard deviations around the mean.
2. Use Monte Carlo. The number of points used will be the same as used for a metamodel based Monte Carlo analysis. A large number of points (10,000 or more) is required. The default of 10,000 points should give the 1 digit of accuracy needed to compare the effects of variables. This option, using 10,000 points, is the default method.

Theoretical concerns are discussed in Section 6.7.

Note that negative values of the variance can occur if computed using the Monte Carlo approach, especially if a small number of Monte Carlo Points is used. In general the analysis should compare the effects of the variables and not the variance. The default of 10,000 points should give the 1 digit of accuracy which means that if the maximum variance is  $3e12$  then negative values of  $-3e10$  can be ignored as zero being two orders of magnitudes smaller. Inspecting the values printed for the effects of the variables should clarify the situation, because the effects are scaled values.

### Command file syntax:

---

```
set dsa method monte carlo
set dsa method meta model
set dsa resolution m
```

---

Item	Description
$M$	Number of sample values

### Example:

```
set dsa method meta model
$ Use Monte Carlo simulation
set dsa method monte carlo
$ use 1000 points in the Monte Carlo simulation
set dsa resolution 1000
```

## 12.6. Covariance

The covariance and coefficient of correlation of the responses will be printed for a Monte Carlo analysis and can also be examined in the Viewer part of the GUI. Theoretical concerns are discussed in Section 6.3.2.

## 12.7. Robust design

The implementation of robust design in LS-OPT only required that the variation of a response be available as a composite. The standard deviation of a response is therefore available for use in a constraint or objective, or in another composite.

The LS-OPT command defining the standard deviation of another response or composite to be a composite is:

```
composite 'var x11' noise 'x11'
```



The variation of response approximated using response surfaces is computed analytically as documented for the LS-OPT stochastic contribution analysis. For neural nets and composites a quadratic response surface approximation is created locally around the design, and this response surface is used to compute the robustness. Note that the recursion of composites (the standard deviation of a composite of a composite) may result in long computational times especially when combined with the use of neural networks. *If the computational times are excessive, then the problem formulation must be changed to consider the standard deviations of response surfaces.*

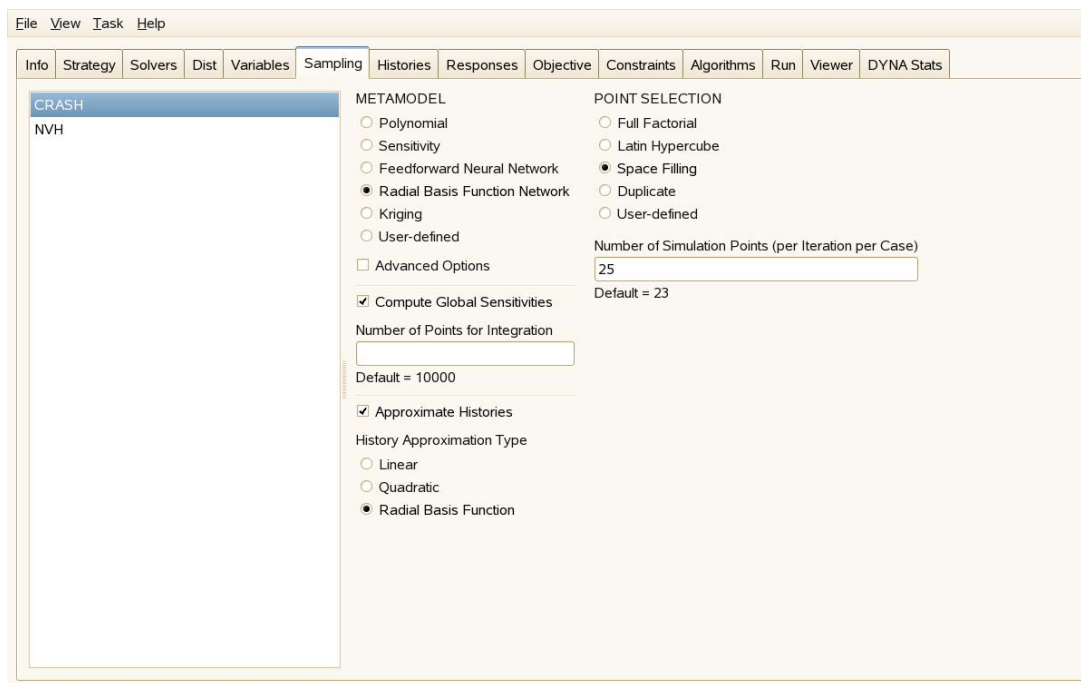
One extra consideration is required to select an experimental design for robust analysis: provision must be made to study the interaction between the noise and control variables. Finding a more robust design requires that the experimental design considers the  $x_i z_j$  cross-terms, while the  $x_i^2$  and  $z_i^2$  terms can be included for a more accurate computation of the variance.

# 13. Metamodels and Point Selection

This chapter describes the specification of the metamodel types and point selection schemes (design of experiments or DOE). The terms *point selection* and *experimental design*, are used interchangeably.

## 13.1. Metamodel definition

The user can select one of the metamodel types shown in Figure 13-1.



**Figure 13-1: Sampling panel in LS-OPT**

The default selection depends on the choice of optimization strategy. For the sequential response surface method (SRSM) strategy, the default choice is the polynomial response surface method (RSM) where response surfaces are fitted to results at data points using polynomials. For global approximations fitted in the single-stage and sequential strategies, the radial basis function networks are set as the default approximation models. For all strategies, the feed-forward neural network, Kriging, and user-defined

approximation models are also available. Sensitivity data (analytical or numerical) can also be used for optimization. This method is more suitable for linear analysis solvers.

**Command file syntax:**

---

```
Solver order [linear| interaction| elliptic| quadratic| FF|  
RBF| kriging| user]
```

---

The linear, interaction (linear with interaction effects), elliptic and quadratic options are for polynomials. FF represents the Feedforward Neural network and RBF represents the radial basis function network.

### 13.1.1. Response surface methodology

When polynomial response surfaces are constructed, the user can select from different approximation orders. The available options are linear, linear with interaction, elliptic and quadratic. Increasing the order of the polynomial results in more terms in the polynomial, and therefore more coefficients. In LSOPT*ui*, the approximation order is set in the Order field. See Figure 13-2.

The polynomial terms can be used during the variable screening process (see Section 2.4) to determine the significance of certain variables (main effects) and the cross-influence (interaction effects) between variables when determining responses. These results can be viewed graphically (Section 18.3.4).

The recommended point selection scheme for polynomial response surfaces is the *D*-optimal scheme (Section 13.3.2).

### 13.1.2. Neural networks and radial basis function networks

To apply neural network or radial basis functions approximations, select the appropriate option in the Metamodel field in LS-OPT*ui*. See Figure 13-3. The recommended Point Selection Scheme for neural networks and radial basis functions is the space filling method. The user can select either a sub-region (local) approach, or update the set of points for each iteration to form a global approximation. An updated network is fitted to *all* the points. See Section 13.9 for more detail on updating.

### 13.1.3. Variability of neural networks\*

Because of the natural variability of neural networks (see Section 3.1.2), the user is allowed to select the number of members in a neural net committee and the centering (averaging) procedure to be used. To ensure distinct members, the regression procedure uses new randomly selected starting weights for generating each committee member. The syntax is shown below.

**Command file syntax:**

---

```
solver FF_committee size [number of members]
```

---

---

```

solver FF_committee discard [number_of_members]
solver FF_committee use [MEAN|MEDIAN]
solver FF_committee seed [integer value]

```

---

The selected attributes apply to the current solver. A seed can be provided to the random number generator (see Section 2.2.7) to ensure a repeatable (but different) committee.

The discard option allows the user to discard *number\_of\_members* committee members with the lowest mean squared fitting error and the *number\_of\_members* committee members with the highest MSE. This option is intended to exclude neural nets which are either under- or over-fitted. The total number of nets excluded in the MEAN or MEDIAN calculation is therefore  $2 * \text{number\_of\_members}$ .

The discard feature is activated during the regression procedure whereas the averaging function (mean/median) is only used during the evaluation procedure. The use of the MEDIAN option simply finds the median value of all the member values obtained at a point, *so different points in the parameter space may not be represented by the same member and the neural net surface plot may be discontinuous*. If a single median neural net is desired, the user must generate an uneven committee size  $n$  and then discard the truncated integer value of  $n/2$  members, e.g. size=5 and discarded=2, 9 and 4, 17 and 8, etc. Size=1 and discarded=0 is the least expensive.

The seed feature allows the generation of a unique set of neural networks. This feature can be used for sensitivity studies. In this case the user must provide a different seed for each new set of networks for the specific solver.

The default attributes of committees are given in Table 13-1. This selection creates a committee of 5 nets and finds the mean value during evaluation. The data for all 5 nets appears in the database file for each specific net, e.g. Net.<variable\_name>.<iteration\_number> in the solver subdirectory.

The variance of the predicted result is reported.

**Table 13-1: Default values for Neural Net committees**

Option	Default
Size	9
Discard	(int) (Size + 3/2)/4
Averaging type	MEAN
Seed	0

Please refer to Sections 3.3 and 4.5 for recommendations on how to use metamodels.

### 13.1.4. Basis functions and optimization criterion for RBF

The performance of the RBFs can significantly vary with the choice of basis function and the optimization criterion. Two basis functions available for selection are Hardy's multi-quadrics, and Gaussian RBF. The user is also allowed to select the optimization criterion to be generalized cross-validation error or the pointwise ratio of the generalized cross validation error. The syntax is shown below.

**Command file syntax:**

---

```
solver RBF transfer [HMQ|GAUSS]
solver RBF optimize [GCV|GCV Ratio|RMSError]
```

---

### 13.1.5. Efficiency of neural networks\*

Neural Network construction calculation may be time-consuming because of the following reasons:

1. The committee size is large
2. The ensemble size is large.

*Committee size.* The default committee size as specified above is largely required because the default number of points when conducting an iterative optimization process is quite small. Because of the tendency of NN's to have larger variability when supplied with fewer points, committees are relied on to stabilize the approximation. When a large number of points have been simulated however, the committee size can be reduced to a single neural net using

```
solver FF_committee size 1
```

*Ensemble size.* The ensemble size can be reduced in two ways: (i) by exactly specifying the architecture of the ensemble and (ii) by providing a threshold to the RMS training error. The architecture is specified as follows:

**Command file syntax:**

---

```
Solver FF_committee ensemble add number_of_hidden_nodes
```

---

*Example*

```
Solver FF_committee ensemble add 0
Solver FF_committee ensemble add 1
Solver FF_committee ensemble add 2
```

represents an ensemble of 0 (linear), 1 and 2 hidden nodes or 0-1-2 from which one will be selected according to the minimum Generalized Cross Validation (GCV) value across the ensemble. The default is Lin-1-2-3-4-5. Higher order neural nets are more expensive to compute.

The threshold for the RMS error is specified as:

**Command file syntax:**

---

```
Solver FF_committee rmerror threshold
```

---

The sorting algorithm will pick the first neural net which falls below the specified threshold starting with 0 hidden nodes (linear). That means that, for a truly linear function, the sorting process will be terminated after 0, resulting in a dramatic saving of computational effort.

*Example:*

```
Solver FF_committee rmerror 0.1
```

for a 10% threshold. See Figure 13-3 for how to specify efficiency options in the GUI.

**13.1.6. Kriging parameters**

The kriging fit depends on the choice of appropriate correlation function and the trend model. Two correlation functions available for selection are Gaussian and exponential. The user can also select either a constant, linear, or quadratic trend model. The syntax is shown below.

**Command file syntax:**

---

```
solver kriging correlation [GAUSS|EXPONENTIAL]  
solver kriging use [constant|linear|quadratic]
```

---

*Remark:*

1. The linear trend model requires atleast  $(N+2)$  design points, and quadratic trend model requires atleast  $0.5(N+1)(N+2) + 1$  design points, where  $N$  is the number of variables.
2. By default, a single set of theta values is fit to all responses, however the user can also fit individual set of correlation function parameters (theta) for each response by using the following command.

---

```
solver kriging select one
```

---

All selections can also be made through the GUI using the ‘Advanced Options’.

**13.1.7. User-defined metamodel**

The user-defined metamodel distribution is available at <http://ftp.lstc.com/user/ls-opt>.

## Building the example

Under Linux, issue the command "make" while in this directory. Your resulting metamodel is called `umm_avgdistance_linux_i386.so` (or `umm_avgdistance_linux_x86_64.so` if running under 64-bit OS).

Under Windows, open `usermetamodel.sln` in Visual Studio. Open the Build menu, select "Build solution". Your resulting metamodel is called `umm_avgdistance_win32.dll`

Along with the metamodel binary you also get an executable called "testmodel". This program can be used for simple verification of your metamodel. Just give the name of your metamodel as a parameter, i.e.:

```
testmodel avgdistance
```

Note that you are not supposed to supply the full `.dll/.so` filename as a parameter.

## Using the example as a template

If you wish to use the example as a template for your own metamodel, do the following steps (in this example, your metamodel is called `mymetamodel`):

Copy `avgdistance.*` to `mymetamodel.*`

Replace any occurrence of the string "avgdistance" with "mymetamodel" in the following files: `Makefile`, `mymetamodel.def`, `mymetamodel.vcproj`, `Makefile`, `usermetamodel.sln`

## Distributable metamodel

When compiled, your metamodel binary will be called something like:

```
umm_mymetamodel_win32.dll
```

or

```
umm_mymetamodel_linux_i386.dll
```

This is the only file that is needed in order to use the metamodel from LS-OPT. It can be placed either in a central repository (which needs to be pointed out by the "solver user metamodel path" command (see below), or in the same directory as the command file that refers to it.

## Referring to user-defined metamodels in LS-OPT command files

In order to use a user-defined metamodel for a certain solver, add the command "solver order user" to the command file, under the appropriate solver.

The following commands apply for user defined metamodels:

**Command file syntax:**

---

```
Solver order user
```

---

The command enables the use of a user-defined metamodel for the current solver.

---

```
Solver user metamodel 'name'
```

---

**Example:**

```
Solver user metamodel 'mymetamodel'
```

Gives the name of the user-defined metamodel (e.g. `umm_mymetamodel_linux_i386.so`). Note this should not include the "umm\_" prefix or the platform dependent suffix. LS-OPT will look for the correct file based upon the current platform. This allows for cross platform operation.

---

```
Solver user metamodel path "path"
```

---

**Example:**

```
  solver user metamodel path "/home/joe/metamodels"
```

specifies where the user defined metamodel may be found. If it is not found in the given directory (or that directory does not exist), LS-OPT will look in the same directory as the current command file. This parameter is optional.

---

```
Solver user metamodel command "string"
```

---

**Example:**

```
  Solver user metamodel command "do it right"
```

Allows the user to send one string parameter to the user-defined metamodel, that may be used in any way by the metamodel. This parameter is optional.

---

```
Solver user metamodel param value
```

---

**Example:**

```
  solver user metamodel param 1.3
```



Allows the user to send a numeric parameter to the user defined metamodel. This statement may be given multiple times for one solver in order to pass many parameters to the metamodel. It is up to the metamodel to specify which, if any, parameters it requires for operation.

## 13.2. Global sensitivity analysis

While the ANOVA is a very popular method to assess the contribution of different regression terms, Sobol's method (based on ANOVA) is widely used to study the importance of different variables for higher order models. In this method, a function is decomposed in the sub-functions of different variables such that the mean of each sub-function is zero and each variable combination appears only once. Then, the variance of each sub-function represents the variance of the function with respect of that variable combination. The theory of the Sobol's method is described in Section 6.7.2. The global sensitivity analysis is carried by selecting the appropriate flag (Compute global sensitivities) in the sampling panel as shown in Figure 13-1. The selection requires the user to specify the number of Monte-Carlo integration points required to compute sensitivities as suggested by Sobol. The sensitivity indices are stored in the Sobol\_GSA.\* XML database file in the *work* directory.

### Command file syntax:

---

```
Use GSA
Set GSA resolution integer
```

---

### Example

```
Use GSA
Set GSA resolution 15000
```

### Remarks:

1. The analytical equations are used to compute sensitivities for polynomials and Gaussian radial basis function metamodels.
2. The composite expressions are always evaluated using the Monte-Carlo integration.
3. The default number of sampling points for Monte-Carlo integration is 10000. This number should be increased for better accuracy of sensitivity coefficients.
4. The sensitivity analysis flag is global i.e., it does not depend on the choice of the solver.

## 13.3. Point selection schemes

### 13.3.1. Overview

Table 13-2 shows the available point selection schemes (experimental design methods).

**Table 13-2: Point selection schemes**

Experiment Description	Identifier	Remark
------------------------	------------	--------

Linear Koshal	lin_koshal	For polynomials
Quadratic Koshal	quad_koshal	
Central Composite	composite	

<i>D</i> -optimal designs		
<i>D</i> -optimal	dopt	Polynomials
Factorial Designs		
$2^n$	2toK	
$3^n$	3toK	
$\vdots$	$\vdots$	
$11^n$	11toK	

Random designs		
Latin Hypercube	latin_hypercube	For probabilistic analysis
Monte Carlo	monte_carlo	
Space Filling designs		
Space Filling 5 (recommended)	space_filling	Algorithm 5 (Section 2.2.6)
Space Filling 0	monte_carlo	-
Space Filling 1	lhd_centralpoint	-
Space Filling 2	lhd_generalized	-
Space Filling 3	maximin_permute	-
Space Filling 4	maximin_subinterval	-

User defined designs		
User-defined	user	
Plan	plan	

**Command file syntax:**

---

```
Solver order [linear| interaction| elliptic| quadratic| FF|
RBF| kriging| user]
Solver experimental design point_selection_scheme
```

---

---

```
Solver basis experiment basis_experiment
Solver number experiment number_experimental_points
Solver number basis experiments
number_basis_experimental_points
```

---

*Example 1:*

```
Solver order quadratic
Solver experimental design dopt
Solver basis experiment 5toK
```

*Example 2:*

```
Solver order linear
Solver experimental design dopt
Solver number experiments 40
Solver basis experiment latin_hypercube
Solver number basis experiments 1000
```

In Example 1, the default number of experiments will be selected depending on the number of design variables. In Example 2, 40 points are selected from a total number of 1000.

In LS-OPT<sub>ui</sub>, the point selection scheme is selected using the Point Selection panel (Figure 13-2).

The default options are preset and are based on the number of variables, e.g., the *D*-optimal point selection scheme (basis type: Full Factorial, 11 points per variable (for  $n = 2$ )) is the default for linear polynomials (Figure 13-2), and the space-filling scheme is the default for the Neural Net and Kriging methods (Figure 13-3).

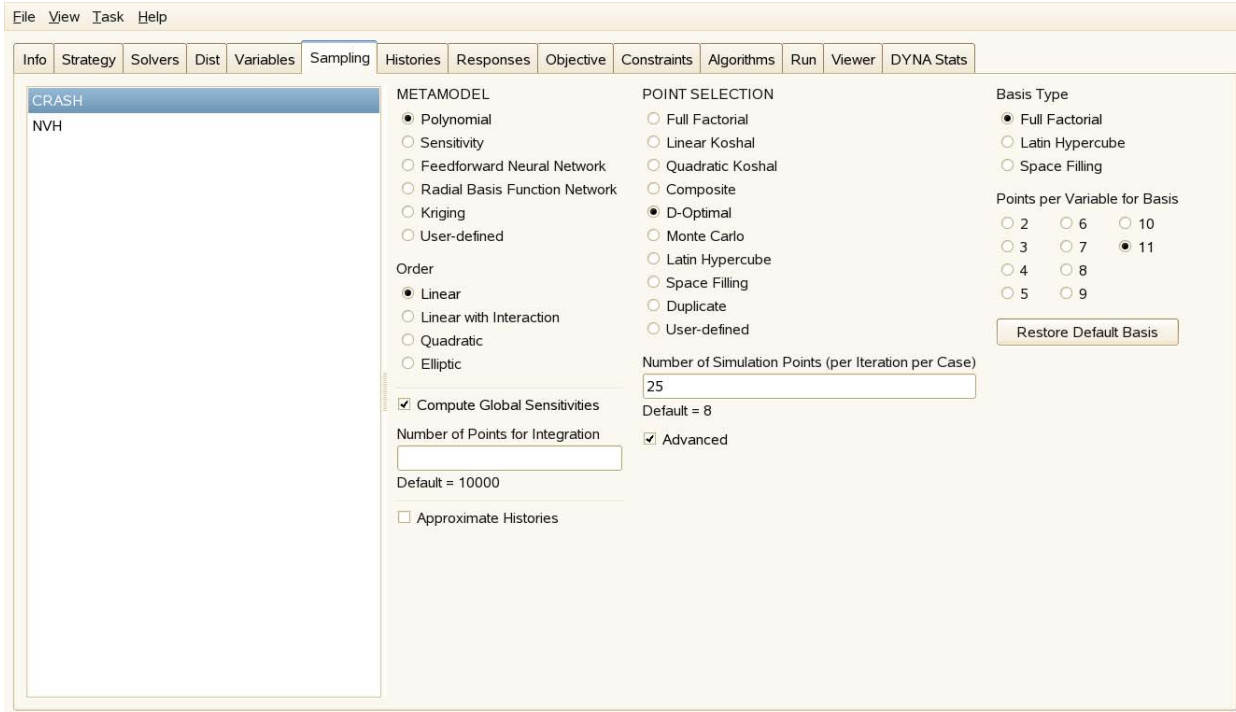


Figure 13-2: Metamodel and Point Selection panel in LS-OPTui (Advanced options (basis experimental design) displayed)

### 13.3.2. D-Optimal point selection

The *D*-optimal design criterion can be used to select the best (optimal) set of points for a response surface from a given set of points. The basis set can be determined using any of the other point selection schemes and is referred to here as the *basis experiment*. The *order* of the functions used has an influence on the distribution of the optimal experimental design.

The following must be defined to select *D*-optimal points.

Order	The order of the functions that will be used. Linear, linear with interaction, elliptic or quadratic.
Number experiments	The number of experimental points that must be selected.
Basis experiment	The set of points from which the <i>D</i> -optimal design points must be chosen, e.g. 3tok
Number basis experiments	The number of basis experimental points (only random, latin hypercube and space filling).

The default number of points selected for the *D*-optimal design is  $\text{int}(1.5(n+1))+1$  for linear,  $\text{int}(1.5(2n+1))+1$  for elliptic,  $\text{int}(0.75(n^2+n+2))+1$  for interaction, and  $\text{int}(0.75(n+1)(n+2))+1$  for quadratic. As a result, about 50% more points than the minimum required are generated. If the user wants to override this number of experiments, the command “solver number experiments” is required.

The default basis experiment for the  $D$ -optimal design is based on the number of variables. For small values of  $n$ , the full factorial design is used, whereas larger  $n$  employs a space filling method for the basis experiment. The basis experiment attributes can be overridden using the commands: `solver basis experiment` and `solver number basis experiments`.

### 13.3.3. Latin Hypercube Sampling

The Latin Hypercube point selection scheme is typically used for probabilistic analysis.

The Latin Hypercube design is also useful to construct a basis experimental design for the  $D$ -optimal design for a large number of variables where the cost of using a full factorial design is excessive. E.g. for 15 design variables, the number of basis points for a  $3^n$  design is more than 14 million.

The Monte Carlo, Latin Hypercube and Space-Filling point selection schemes require a user-specified number of experiments.

Even if the Latin Hypercube design has enough points to fit a response surface, there is a likelihood of obtaining poor predictive qualities or near singularity (when fitting polynomials) during the regression procedure. It is therefore better to use the  $D$ -optimal experimental design for RSM.

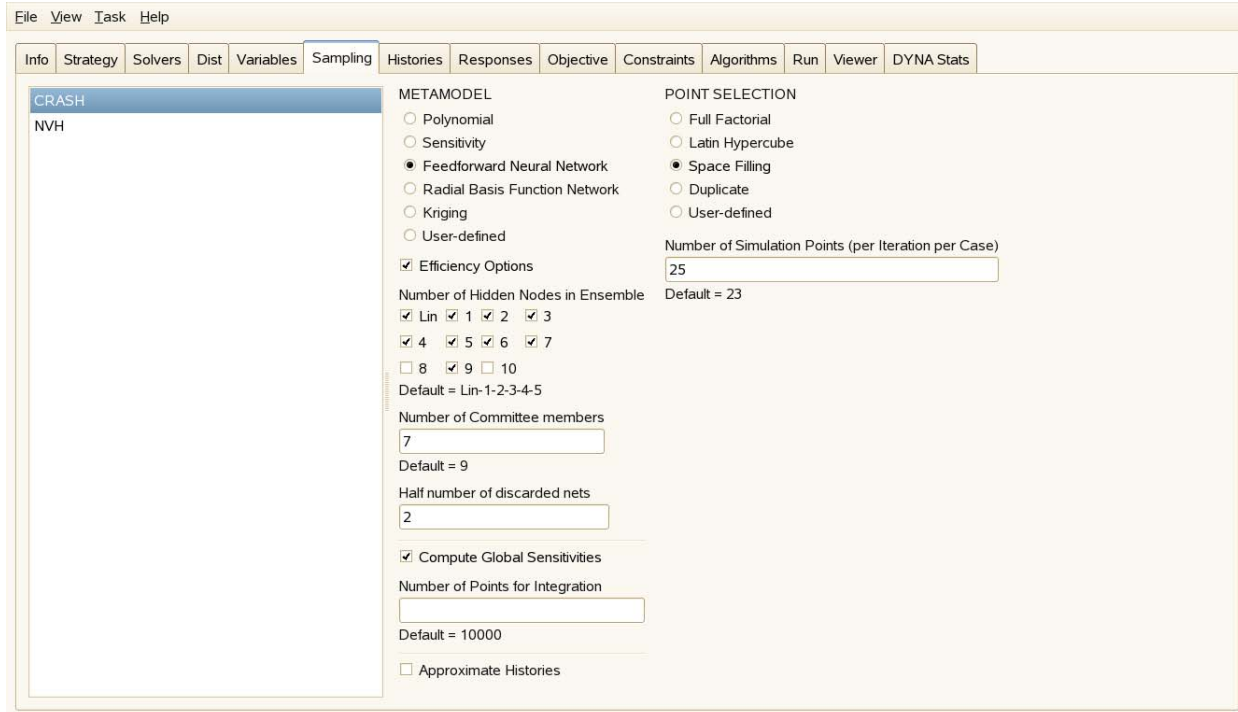
Latin Hypercube sampling uses the Space Filling 2 algorithm default.

*Example:*

```
Solver order linear
Solver experimental design lhd_generalized
Solver number experiment 20
```

### 13.3.4. Space Filling

When selecting Space Filling in LS-OPTui, Algorithm 5 (see Section 2.2.6) will be used by default. This algorithm maximizes the minimum distance between experimental design points. The only data required is the number of sampling points. Space Filling is suitable for the Radial Basis Function and Neural Networks, as well as Kriging methods (see Section 13.1.2).



**Figure 13-3:** Selecting the Feedforward neural network approximation method in the Point Selection panel (Efficiency options displayed).

### 13.3.5. Space Filling of Pareto Optimal Frontier

By selecting to create the Pareto Optimal Frontier (POF) as a strategy, a Space Filling algorithm which applies discrete Space Filling sampling of the POF is available. This sampling method uses the POF created in the previous iteration as a basis design point set. The distance between the points is maximized and can also be maximized with respect to previous simulation points by selecting to augment the design points. The user can specify the number of points required.

#### *How to use the Pareto Optimal Frontier as a basis set for sampling*

The following procedure can be followed to conduct simulations based on the POF. It is assumed that the user has conducted one or more metamodel-based iterations and that the POF has been created based on the metamodel.

1. Strategy:
  - a. If not selected already, select any Sequential strategy.
  - b. As an *Advanced* setting, choose to restart and set the iteration number at which you want to restart. For example, if one iteration is already available, set the starting iteration to 2. This setting is only required if the number of simulations required differs from the current setting.

## 2. Sampling:

*For each case:*

- a. Choose to conduct *Space Filling of Pareto Frontier* as a Sampling option.
  - b. Choose whether previous simulation points are to be considered in the Space Filling algorithm (check the box “Include pts of Previous Iterations”).
  - c. Choose the number of simulation points required. The simulation will stop automatically if the POF basis set is too small.
3. *Constraints:* The constraint values can be adjusted to filter POF points. Set the “Move” option for those constraints which are to be applied as sampling filters.
- The constraints can be added or changed immediately before the final run, so do not have to be precise from the very beginning.
4. *Run:* Increase the iteration limit by 1 assuming only 1 more iteration is to be done.
- To delete any existing runs which may exist in Iteration 2 (such as a previous verification run), choose “Clean Start” from Iteration 2.

### 13.3.6. User-defined point selection

#### *Comma separated variables*

A user-defined experimental design can be specified in a text file using the *.csv (comma separated variables)* format. The `user` option (“User *.csv*” in the GUI) allows the user to import a table from a text file with the following keyword-based format:

```
"Point", "tbumper", "thood",
"sk", "dv", "dv",
1, 3.0000000000000000e+00, 1.0000000000000000e+00,
2, 5.0000000000000000e+00, 1.0000000000000000e+00,
3, 1.0000000000000000e+00, 1.0000000000000000e+00,
4, 1.0000000000000000e+00, 5.0000000000000000e+00,
5, 5.0000000000000000e+00, 5.0000000000000000e+00,
```

The two header lines are required. The variable types are design variables (`dv`) or noise variables (`nv`) respectively. The variable names assure that each column is tied to a specific name and will be displayed as variables in the “Variables” panel. The variable types defined in the user file will take precedence over other type definitions of the same variable (e.g. from the input files) if the user switches to the “Variables” panel only after firstly selecting the file to be imported in the “Sampling” panel.

The `sk` variable type can be used to screen out variables. Therefore variables of the `sk` type will not appear on the **Variables** page when importing the file.

This format is convenient for use with Microsoft Excel which allows the export of a *.csv* text file. The browser for specifying an input file has a filter for *.csv* files. This feature is also ideal for setting up an LS-OPT run with using an exported file of Pareto Optimal points. Such as file can be produced using the Viewer.

### Free format

A user-defined experimental design can also be specified in a text file using a free format. The `user` option (“User-defined” in the GUI) allows the user to import a table from a text file with the following keyword-based format:

```
lso_numvar 2
lso_numpoints 3
lso_varname          t_bumper    t_hood
lso_vartype          dv           nv
This is a comment    lso_point    1.0      2.0
                    lso_point    2.0      1.0
                    lso_point    1.0      1.0
```

The keywords (e.g. `lso_numvar`) except `lso_vartype` are required but can be preceded or followed by any other text or comments. The variable types are design variables (`dv`) or noise variables (`nv`) respectively. The variable names assure that each column is tied to a specific name and will be displayed as variables in the “Variables” panel. The variable types defined in the user file will take precedence over other type definitions of the same variable (e.g. from the input files) if the user switches to the “Variables” panel only after firstly selecting the file to be imported in the “Sampling” panel.

This format is convenient for use with Microsoft Excel which allows the export of a `.txt` text file. The browser for specifying an input file has a filter for `.txt` files.

## 13.4. Sampling at discrete points

A flag is provided to select the sampling points at specified discrete values of the variables. Discrete sampling will also handle discrete-continuous problems correctly. In the GUI, a check box is located as a *D*-Optimal advanced option for each case (See Figure 13-2). Discrete sampling is based on selecting a discrete basis set for *D*-Optimality and is therefore not available for other point selection schemes. Discrete sampling is only available if discrete variables are specified.

See Section 11.5 for how to specify a discrete variable.

### Command file syntax:

---

```
Solver basis experiment discrete
```

---

## 13.5. Duplicating an experimental design

When executing a search method (see e.g. Section 4.6) for a multi-case or multidisciplinary optimization problem, the design points of the various disciplines must be duplicated so that all the responses and composites can be evaluated for any particular design point. The command must appear in the environment of the solver requiring the duplicate points. An experimental design can therefore be duplicated as follows:



**Command file syntax:**

---

```
solver experiment duplicate string
```

---

where *string* is the name of the master solver in single quotes, e.g.

```
Solver experiment duplicate 'CRASH'
```

'CRASH' is the master experimental design that must be copied exactly.

Multi-case composites not accompanied by case duplication cannot be visualized in 2-D or 3-D point plots. This is a mandatory step for using 'Direct GA' solver with multiple cases. See also the example in Section 22.5.

## 13.6. Replicate experimental points

When using stochastic fields, any particular design point can be (re-)analyzed using different stochastic fields. These are then replicate evaluations of the same design. The stochastic field is controlled using the LS-DYNA® \*PERTURBATION and \*PARAMETER cards. Note that the RND (random number seed) field of the card can be set to 0 to allow the field to vary freely, or set to a positive number to get a specific stochastic field.

**Command file syntax:**

---

```
solver number replicate experiment number
```

---

Example:

```
Solver number replicate experiment 5
```

So, in the above, if the original experimental design had 9 point, then 45 FEA evaluations will be done. See also the example in Section 22.5.

## 13.7. Augmentation of an existing design

To retain existing (expensive) simulation data in the optimization process, it is advantageous to be able to augment an existing metamodel with additional sampling points and simulations. In this manner, can new simulations be added to old simulations to obtain a more accurate metamodel. This is performed by

increasing the number of sampling points in the **Sampling** tab of the GUI and restarting the metamodel-based optimization.

When running the optimization, the experimental design table will be augmented, the additional simulations will be executed, a new metamodel will be constructed and a new predicted optimum will be computed. *Note* that if a verification run was previously calculated (Simulation 2.1), the restart should be a clean start for *Iteration 2* in order to replace the verification run in 2.1. It is no longer required to use the Repair function to conduct metamodel augmentation.

## 13.8. Specifying an irregular design space

An irregular (reasonable) design space refers to a region of interest that, in addition to having specified bounds on the variables, is also bounded by arbitrary constraints. This may result in an irregular shape of the design space. This region of interest is thus defined by constraint bounds and by variable bounds. The purpose of an irregular design space is to avoid designs which may prove to be impossible to analyze.

The `move/stay` commands can be used to define an environment in which the constraint bound commands (Section 16.4) can be used to double as bounds for the reasonable design space.

Only explicit constraints, i.e. constraints that do not require simulations, can be specified for the reasonable design space. A typical explicit constraint could be a simple inequality relationship between the design variables.

### Command file syntax:

---

```
move
stay
move start
```

---

#### *Example 1:*

```
Variable 'Radius_1' 20.0
Variable 'Radius_2' 20.0
.
.
Composite 'TotalR' {Radius_1 + Radius_2}
move
Constraint 'TotalR'
Upper bound constraint 'TotalR' 50
```

This specification of the `move` command ensures that the points are selected such that the sum of the two variables does not exceed 50.

#### *Remarks:*

1. A reasonable design space can be created using the *D*-optimal experimental design as well as the Space Filling experimental design. These are the most commonly used options that accompany the choice of polynomials, Radial Basis Function Networks, Neural Networks or Kriging as metamodels.

## 13.9. Automatic updating of an experimental design

Updating the experimental design involves augmenting an existing design with new points. Updating only makes sense if the response surface can be successfully adapted to the augmented points such as for neural nets, Radial Basis Function networks or Kriging surfaces in combination with a space filling scheme. The choice of any of these metamodels always implies automatic updating.

### Command file syntax:

---

```
solver update doe
```

---

The new points have the following properties:

- They are located within the current region of interest.
- The minimum distance between the new points and between the new and existing points, is maximized (space filling only).

## 13.10. Using design sensitivities for optimization

Both analytical and numerical sensitivities can be used for optimization. The syntax for the `solver experimental design` command is as follows:

Experiment Description	Identifier
Numerical Sensitivity	<code>numerical_DSA</code>
Analytical Sensitivity	<code>analytical_DSA</code>

### 13.10.1. Analytical sensitivities

If analytical sensitivities are available, they must be provided for each response in its own file named `Gradient`. The values (one value for each variable) in `Gradient` should be placed on a single line, separated by spaces.

In `LS-OPTui`, the Metamodel (Point Selection panel) must be set to Sensitivity Type → Analytical. See Figure 13-4.

#### *Example:*

```
Solver experimental design analytical_DSA
```

A complete example is given in Section 22.8.

### 13.10.2. Numerical sensitivities

To use numerical sensitivities, select Numerical Sensitivities in the Metamodel field in LS-OPT<sub>ui</sub> and assign the perturbation as a fraction of the design space.

Numerical sensitivities are computed by perturbing  $n$  points relative to the current design point  $\mathbf{x}_0$ , where the  $j$ -th perturbed point is:

$$x_i^j = x_i^0 + \delta_{ij} \varepsilon (x_{iU} - x_{iL})$$

$\delta_{ij} = 0$  if  $i \neq j$  and 1.0 if  $i = j$ . The perturbation constant  $\varepsilon$  is relative to the design space size. The same value applies to all the variables and is specified as:

#### Command file syntax:

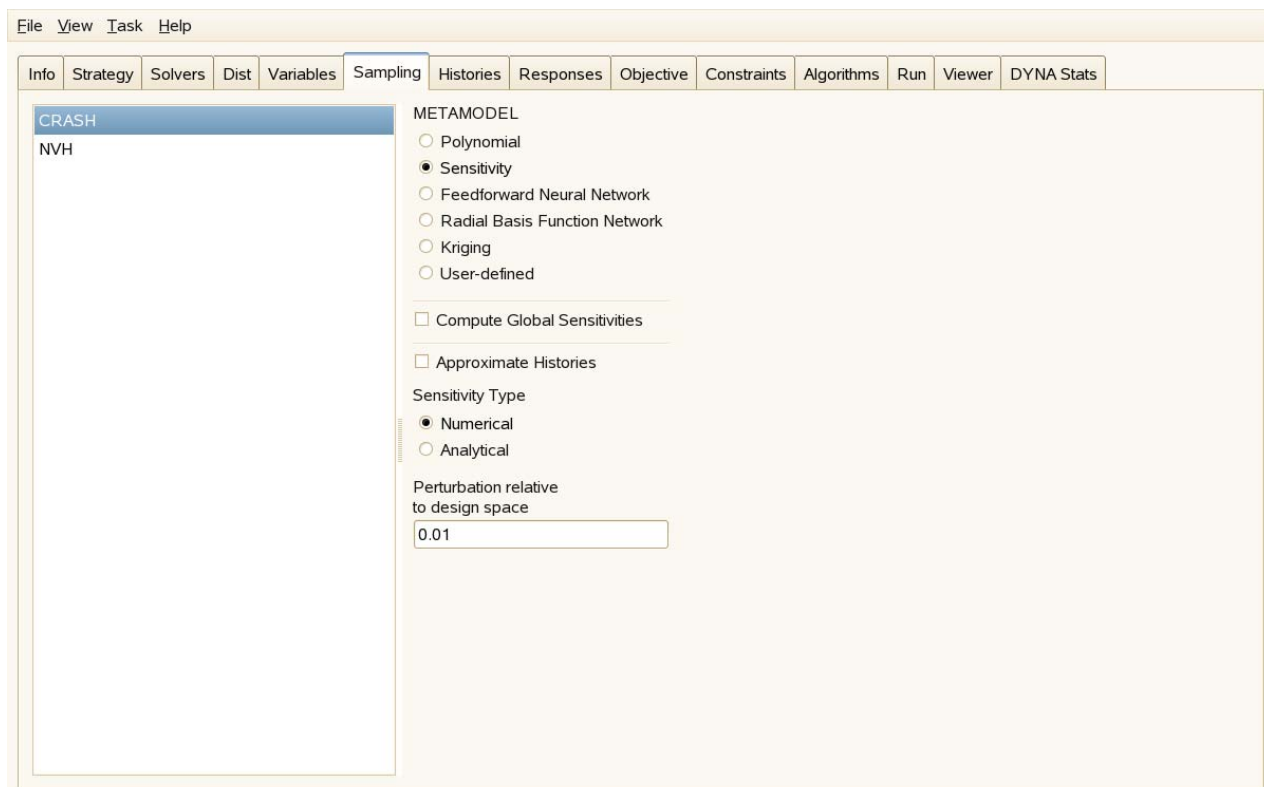
---

```
Solver perturb perturbation_value
```

---

#### Example:

```
Solver experimental design numerical_DSA
Solver perturb 0.01
```



*Figure 13-4: Selecting Sensitivities in the Point Selection panel*

## 13.11. Checkpoints

The error measures of any number of designs (checkpoints) can be evaluated using an existing metamodel. There are two simple steps to obtaining a table with error data.

1. Browse for the file with the checkpoint information using the **Checkpoints** tab in the **Solvers** panel. The file must be in `.csv` format although spaces, commas or tabs are allowed as delimiters. The file must contain two header lines. The first header line contains the variable and response names. The second header line contains the variable and response types; in this case "dv" and "rs". The variable coordinates are then specified as one row for each design point. See example below.
2. Use the **Evaluate Metamodels** option in the **Repair** task menu and run the task (see Section 17.10).

Cases without checkpoint files will be ignored.

**Command file syntax:**

---

```
solver check file file_name
```

---

*Example:*

```
solver check file "checkpoints2"
solver check file "/user/bob/lsopt/checkpoints2•
```

checkpoints2 file:

```
x1, x2, x3, Disp, Acc
dv, dv, dv, rs, rs
1.0, 1.3, 1.2, 123.6, 1278654.7
2.1, 2.2, 639.2, 2444588.1
```

## 13.12. Metamodel Evaluation using a set of design points

The response values of any number of points can be computed using an existing metamodel and written to a `.csv` file (file with comma-separated variables that can be read with most spreadsheet programs). The input data is case independent.

There are two simple steps to obtain a table with response data.

1. Browse for the file with the sampling point information using the **Evaluate Metamodel** tab on the **Solvers** page and **Replace**. The file must be in `.csv` format although spaces, commas or tabs are allowed as delimiters. The file must contain two header lines. The first header line contains the variable names. The second header line contains the variable types; in this case "dv" (design variable) suffices. The variable coordinates are specified as one row for each design point. See example below.
2. Use the **Analyze Metamodels** option in the Repair task menu and run the task (Section 17.7). This is the same repair option as for the "checkpoints" in Section 13.11 above.

- *Input:* Each sampling point file must represent all the variables. LS-OPT checks whether all the variables defined in the file are represented in the LS-OPT input. Variable order is not important.
- *Output:* The `ExtendedResults` output can be found as a `META` file in the main working directory, e.g. `ExtendedResultsMETAMaster_3.csv`. The `ExtendedResults` file has variable, dependent, response, composite, objective, constraint, multi-objective and constraint violation values.
- If sampling points are defined before the start of an optimization run, the `META` file will be automatically computed for each iteration.

**Command file syntax:**

---

```
solver evaluate file file_name
```

---

As the input file is case independent, only one command is specified for the first case.

*Example:*

```
solver evaluate file •UserPoints•  
solver evaluate file "/user/bob/lsopt/UserPoints2"  
solver evaluate file "C:\lsopt\UserPoints2"  
solver evaluate file "my_user_files/UserPoints3•
```

UserPoints file:

```
x1 x2 x3  
dv dv dv  
1.0 2.0 3.0  
2.0 3.0 4.0  
4.1 6.2 3.3
```

### 13.13. Alternative point selection

Alternative point selection schemes can be specified to replace the main scheme in the first iteration. The main purpose is to provide an option to use linear D-optimality in the first iteration because:

1. D-optimality minimizes the size of the confidence intervals to ensure the most accurate variable screening, usually done in the first iteration.
2. It addresses the variability encountered with neural networks due to possible sparsity (or poor placement) of points early in the iterative process, especially in iteration 1, which has the lowest point density.

**Command file syntax:**

---

```
solver alternate experiment 1
```

---

---

```

solver alternate order linear
solver alternate experimental design point_selection_scheme
solver alternate number experiment number_experimental_points
solver alternate basis experiment basis_experiment
solver alternate number basis experiments
                        number_basis_experimental_points

```

---

The defaults are as follows:

<i>Attribute</i>	<i>Default</i>
Order	Linear (only option available)
Experimental design	D-Optimal
Number of experiments	Number of experiments of main experimental design
Basis experimental design	type depends on number of variables (only D-optimal)
Number of basis experiments	depends on basis experiment type and number of experiments (only D-optimal)

*Example:*

```

Solver order FF
Solver experimental design space filling
Solver number experiments 5
Solver update doe
Solver alternate experiment 1

```

In the above example a linear surface based on D-optimal point selection will be used in the first iteration instead of a neural network based on Space Filling. The number of points is 5, the same as for the main experimental design. In the second iteration all the points created in the first and second iterations will be used to fit a neural network (because of update doe). The single additional line is typically all that is needed when using neural networks.

*Example:*

```

Solver order FF
Solver experimental design space filling
Solver number experiments 5
Solver alternate experiment 1
  Solver alternate experimental design dopt
  Solver alternate order linear
  Solver alternate basis experiments space_filling
  Solver alternate number basis experiments 100

```

### 13.14. Changing the number of points on restart\*

The number of points to be analyzed can be changed starting with any iteration. This feature is useful when the user wants to restart the process with a different (often larger) number of points. This option avoids adding points in iterations prior to the specified iteration. The feature is case-specific, so must be added to all the case definitions.

**Command file syntax:**

---

```
Solver experiment augment iteration iteration_number
```

---

*Example 1:*

In the first analysis, the following sampling scheme was specified:

```
Solver experiment design dopt
Solver number experiment 5
Solver basis experiment 3toK
.
.
.
Iterate 1
```

By default, a single verification run is done in iteration 2.

After the first analysis, the user wants to restart, using a larger number of points

```
Solver experiment design dopt
Solver number experiment 10
Solver basis experiment 5toK
Solver experiment augment iteration 2
.
.
.
Iterate 3
```

Iterations 2 and 3 will then be conducted with 10 points each while iteration one will be left intact.

*Example 2:*

Starting with:

```
Solver experiment design dopt
Solver number experiment 5
.
.
.
Iterate 1
```

and restarting with:

```
Solver experiment design dopt
Solver number experiment 10
Solver experiment augment iteration 1
.
.
.
Iterate 3
```



iteration 1 of the restart will be augmented with 5 points (to make a total of 10), before continuing with 10 points in further iterations.

*Note:* The user will have to delete the single verification point generated in the first analysis before restarting the run. For this example, this can be done by entering “2” in the box for “Specifying Starting Iteration” in the Run panel. The restart will then generate a *new* starting point for iteration 2 and conduct 10 simulations altogether.

### 13.15. Repeatability of point selection

All point selection schemes are repeatable, but a seed can be provided to create different sets of random points. The feature is particularly useful for Monte Carlo or Latin Hypercube point selections which both directly use random numbers. Because D-Optimal and Space Filling designs also use random numbers, albeit less directly, they may only show small differences due to the occurrence of local minima in the respective optimization procedures. The seed is of the type “unsigned long”, so the value typically has to be between 0 and 4,294,967,295 (depending on the machine architecture). The syntax is as follows:

Command file syntax:

---

```
Solver experiment seed integer_value
```

---

The default value is 0 (zero).

```
Solver experimental design lhd_generalized
Solver number experiments 30
Solver experiment seed 349177
```

### 13.16. Remarks: Point selection

1. The files Experiments and AnalysisResults are synchronous, i.e. they will always have the same experiments after extraction of results. Both these files also mirror the result directories for a specific iteration.
2. Design points that replicate the starting point are omitted during the sampling phase.

# 14. History and Response Results

This chapter describes the specification of the history or response results to be extracted from the solver database. The chapter focuses on the standard response interfaces for LS-DYNA.

## 14.1. Defining a response history (vector)

A response history can be defined by using the `history` command with an extraction, a mathematical expression or file import. The extraction of the result can be done using a standard LS-DYNA interface (see Section 14.4) or with a user-defined program.

### Command file syntax:

---

```
history history_name string
history history_name case-id string
history history_name expression math_expression
history history_name file string
```

---

The *string* is an interface definition (in double quotes), while the *math\_expression* is a mathematical expression (in curly brackets). The *case-id* field is the integer CASE ID associated with the \*CASE parameter in LS-DYNA. This field is mandatory for disciplines that use \*CASE parameter in LS-DYNA input files but is not required for other cases.

### Example 1:

```
history 'displacement_1' "BinoutHistory -res_type nodout -cmp x_displacement -
id 12789 -filter SAE -filter_freq 60"
history 'displacement_2' "BinoutHistory -res_type nodout -cmp x_displacement -
id 26993 -filter SAE -filter_freq 60"
history 'v_y_150' 30 "BinoutHistory -res_type nodout -cmp y_velocity -id 250"
history 'deformation' expression {displacement_2 - displacement_1}
response 'final_deform' expression {deformation(200)}
```

### Example 2:

```
constant 'v0' 15.65
```

```

history 'bumper_velocity' "BinoutHistory -res_type nodout -cmp x_velocity -id
73579 -filter SAE -filter_freq 30"
history 'Apillar_velocity_1' "BinoutHistory -res_type nodout -cmp
x_velocity -id 41195 -filter SAE -filter_freq 30"
history 'Apillar_velocity_2' "BinoutHistory -res_type nodout -cmp
x_velocity -id 17251 -filter SAE -filter_freq 30"
history 'global_velocity' "BinoutHistory -res_type glstat -cmp X_VEL "
history 'Apillar_velocity_average' expression {
                                (Apillar_velocity_1 + Apillar_velocity_2)/2}
$
response 'time_to_bumper_zero' expression {Lookup("bumper_velocity(t)",0)}
response 'vel_A_bumper_zero' expression {Apillar_velocity_average
(time_to_bumper_zero)}
response 'PULSE_1' expression {Integral
                                ("Apillar_velocity_average(t)",
                                0,
                                time_to_bumper_zero)
                                /time_to_bumper_zero}
response 'time_to_zero_velocity' expression {Lookup("global_velocity(t)",0)}
response 'velocity_final' expression
{Apillar_velocity_average(time_to_zero_velocity)}
response 'PULSE_2' expression {Integral
                                ("Apillar_velocity_average(t)"
                                time_to_bumper_zero,
                                time_to_zero_velocity)
                                /(time_to_zero_velocity - time_to_bumper_zero)}

```

*Example 3:*

```

constant 'Event_time' 200
$ Results from a physical experiment
history 'experiment_vel' file "expdata"
$ LS-DYNA results
history 'velocity' "BinoutHistory -res_type nodout -cmp x_velocity -id 12667"
response 'RMS_error' expression {Integral("(experiment_vel-
velocity)**2",0,Event_time)}

```

*Example 4:*

In this example a user-defined program (the post-processor LS-PREPOST) is used to produce a history file from the LS-DYNA database. The LS-PREPOST command file `get_force`:

```

open d3plot d3plot
ascii rforc open rforc 0
ascii rforc plot 4 Ma-1
xyplot 1 savefile xypair LsoptHistory 1
deletewin 1
quit

```

produces the `LsoptHistory` file.

```

history 'Force' "lsprepost c=../../get_force"
response 'Force1' expression {Force(.002)}

```

```

response 'Force2' expression {Force(.004)}
response 'Force3' expression {Force(.006)}
response 'Force4' expression {Force(.008)}

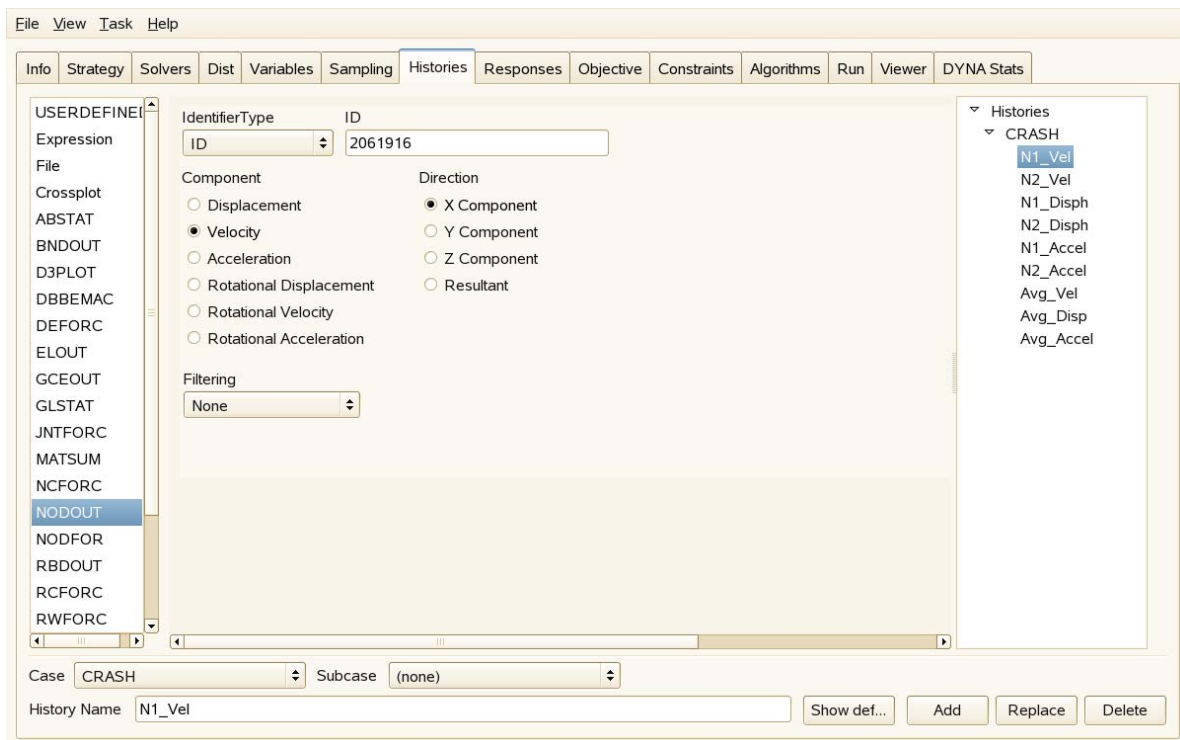
```

*Note* : The *reforc* history in Example 4 can be obtained more easily by direct extraction (see Section 14.5.1 and **Appendix B**)

*Remarks*:

1. Histories are used by response definitions (see Section 14.1.1) to define a response surface. They are therefore intermediate entities and cannot be used directly to define a response surface. Only `response` can define a response surface.
2. For LS-DYNA history definition and syntax, please refer to Section 14.4.

In LS-OPT*ui*, histories are defined in the Histories panel (Figure 14-1):



**Figure 14-1: Histories panel in LS-OPT*ui***

### 14.1.1. Crossplot history

A special history function `Crossplot` is provided to construct a curve  $g(f)$  given  $f(t)$  and  $g(t)$ .

**Expression syntax:**


---

History 'curvename' {Crossplot (*abscissa history*,  
*ordinate history*, [numpoints, begin, end])}

---

**Table 14-1: Description of Crossplot arguments**

Argument name	Description	Symbol	LS-OPT Type	Default
<i>abscissa history</i>	History of abscissa	$f(t)$	Expression	-
<i>ordinate history</i>	History of ordinate	$g(t)$	Expression	-
<i>numpoints</i>	Number of points created in crossplot	$P$	Int	Smallest of the numbers of points defining $f$ and $g$
<i>begin</i>	Begin $t$ -value	$t_l$	Float	Largest $t_0$ -value of $f$ and $g$
<i>end</i>	End $t$ -value	$t_p$	Float	Smallest $t_p$ -value of $f$ and $g$

Examples:

```

$ ----- CROSSPLOT CURVES -----
history 'Force_Disp_Dflt' expression {Crossplot("-Disp2", "Force2") }
history 'Force_Disp_to_Num' expression {Crossplot("-Disp2", "Force2", 2) }
history 'Force_Disp_to_Beg' expression {Crossplot("-Disp2", "Force2", 4, 0.002) }
history 'Force_Disp_to_End' expression {Crossplot("-Disp2", "Force2", 4, 0.002, End) }

```

**14.1.2. Derivative history**

A special history function DerivativeHistory is provided to construct a curve  $\frac{df(t)}{dt}$  given  $f(t)$ .

**Expression syntax:**


---

History 'curvename' {DerivativeHistory (*history*, [order])}

---

**Table 14-2: Description of DerivativeHistory arguments**

Argument name	Description	Symbol	LS-OPT Type	Default
<i>history</i>	Pre-defined history	$f(t)$	History	-
<i>order</i>	Number of points in the numerical derivative stencil		Integer	5

Remarks:

1. The derivatives assume a linear, positive abscissa with equal intervals (typically time history).
2. Only orders 3 and 5 are available. The default is 5.
3. Since the derivative approximation is based on a multipoint scheme, it is recommended to avoid having too few points.
4. For the 5-point scheme, the derivatives of the first three and last three points are the same as the third and third last points respectively. For the 3-point scheme, the same is valid for the first and last two points.

$$\frac{df(t)}{dt} \Big|_{O=3} \approx \frac{f(x+h) - f(x-h)}{2h}$$

$$\frac{df(t)}{dt} \Big|_{O=5} \approx \frac{-f(x+2h) + 8f(x+h) - 8f(x-h) + f(x-2h)}{12h}$$

Examples:

```
$ ----- DERIVATIVE CURVES -----
history 'Deriv1' expression {DerivativeHistory("Disp", 3) }
history 'Deriv2' expression {DerivativeHistory("Disp") }
```

### 14.1.3. Filtered history

A special history function `FilterHistory` is provided to construct a filtered curve.

#### Expression syntax:

---

```
History 'curvename' {FilterHistory (history, [filter_type,
filter_frequency, timeunits, num_average_points])}
```

---

Table 14-3: Description of `FilterHistory` arguments

Argument name	Description	Symbol	LS-OPT Type	Default
<i>history</i>	Pre-defined history	<i>f(t)</i>	History	-
<i>filter_type</i>	Filtering type (FILTER_SAE, FILTER_BUTTERWORTH, FILTER_AVERAGE)		Integer	FILTER_SAE
<i>filter_frequency</i>	Filtering frequency in Hz		Float	60 Hz
<i>time_units</i>	Units of time (TIME_S or TIME_MS)		Integer	TIME_S
<i>num_average_points</i>	Number of averaging points		Integer	5

Examples:

```
history 'a' "BinoutHistory -res_type nodout -cmp x_acceleration -id 167"
```

```

history 'a_FILTER_SAE_60' "BinoutHistory -res_type nodout -cmp x_acceleration -id 167 -filter
SAE -filter_freq 60.0000"
$
$----- FILTERED HISTORIES -----
$
history 'h_FILTER_SAE_60_time_s' expression {FilterHistory( "a(t)", FILTER_SAE, 60.0, TIME_S ) }
history 'h_FILTER_SAE_60_time_ms' expression {FilterHistory("a(t)",FILTER_SAE,60.0, TIME_MS ) }
history 'h_FILTER_SAE_60_time_ms_2' expression {FilterHistory ( "a", FILTER_SAE, 60.0,TIME_MS) }
history 'h_FILTER_SAE_60' expression {FilterHistory ( "a(t)", FILTER_SAE, 60.0 ) }
history 'h_FILTER_SAE' expression {FilterHistory ( "a(t)", FILTER_SAE ) }
history 'h_FILTER' expression {FilterHistory ( "a(t)" ) }
history 'h_FILTER_BUTTERWORTH_60_time_s' expression {FilterHistory ( "a(t)", FILTER_BUTTERWORTH,
60.0, TIME_S ) }
history 'h_FILTER_BUTTERWORTH_60' expression {FilterHistory ( "a(t)",FILTER_BUTTERWORTH,60.0 ) }
history 'h_FILTER_BUTTERWORTH' expression {FilterHistory ( "a(t)", FILTER_BUTTERWORTH ) }
history 'h_FILTER_AVERAGE_5' expression {FilterHistory ( "a(t)", FILTER_AVERAGE, _, _, 5 ) }
history 'h_FILTER_AVERAGE' expression {FilterHistory ( "a(t)", FILTER_AVERAGE ) }
history 'h_FILTER_SAE_10' expression {FilterHistory ( "a(t)", FILTER_SAE, 10 ) }
history 'h_FILTER_SAE_100' expression {FilterHistory ( "a(t)", FILTER_SAE, 100 ) }
history 'h_FILTER_SAE_150' expression {FilterHistory ( "a(t)", FILTER_SAE, 150 ) }
history 'h_FILTER_SAE_200' expression {FilterHistory ( "a(t)", FILTER_SAE, 200 ) }
history 'h_FILTER_AVERAGE_50' expression {FilterHistory ( "a(t)", FILTER_AVERAGE, _, _, 50 ) }
history 'DerivativeHistory_a' expression {DerivativeHistory ( "a(t)" )}
history 'Filter_DerivativeHistory_a' expression {FilterHistory ( "DerivativeHistory_a(t)" ) }
history 'DerivativeHistory_a_FILTER_SAE_60' expression {DerivativeHistory("a_FILTER_SAE_60(t)"
)}

```

#### 14.1.4. History files

A history can be provided in a text file with arbitrary format. Coordinate pairs are found by assuming that any pair of numbers in a row is a legitimate coordinate pair. History files are typically used to import test data for parameter identification problems.

#### Command file syntax:

---

```
history name file filename
```

---

#### Example:

History •Test1' file •Test1.txt•

where Test1.txt contains:

```

Time    Displacement
1.2,    143.97
1.4,    156.1
1.7,    923.77

```

## 14.2. Defining a response (scalar)

The extraction of responses consists of a definition for each response and a single extraction command or mathematical expression. A response is often the result of a mathematical operation of a response history,

but can be extracted directly using the standard LS-DYNA interface (see Section 14.4) or a user-defined interface.

Each extracted response is identified by a name and the command line for the program that extracts the results. The command line must be enclosed in double quotes. If scaling and/or offsetting of the response is required, the final response is computed as (the extracted response  $\times$  *scale factor*) + *offset*. This operation can also be achieved with a simple mathematical expression. A mathematical expression for a response is defined in curly brackets after the response name. If a discipline generates multiple cases (using LSDYNA \*CASE parameter), the user must also specify the corresponding CASE ID.

#### Command file syntax:

---

```
response response_name {scale_factor offset} string
response response_name {scale_factor offset case-id} string
response response_name expression math_expression
```

---

#### Example:

```
response 'Displacement_x' 25.4 0.0 "DynaASCII nodout 'r disp' 63 Timestep 0.1"
response 'Displacement_y' 1 0 30 "BinoutResponse -res_type Nodout -cmp
y_displacement -id 150 -select TIME "
response 'Force' "$HOME/ownbin/calculate force"
response 'Displacement_y' "calc constraint2"
response 'Disp' expression {Displacement_x + Displacement_y}
```

#### Remarks:

1. The first command will use a standard interface for the specified solver package. The standard interfaces for LS-DYNA are described in Section 14.4.
2. The middle two commands are used for a user-supplied interface program (see Section 14.11). The interface name must either be in the path or the full path name must be specified. Aliases are not allowed.
3. The case-id field is mandatory for disciplines with input files that use \*CASE parameter. For all other cases, first/last commands should be used.
4. For the last command, the second argument `expression` is a reserved name.

### 14.3. Specifying the metamodel type

The metamodel type can be specified for an individual response.

#### Command file syntax:

---

```
response response_name
[linear | interaction | elliptic | quadratic | FF | kriging]
```

---

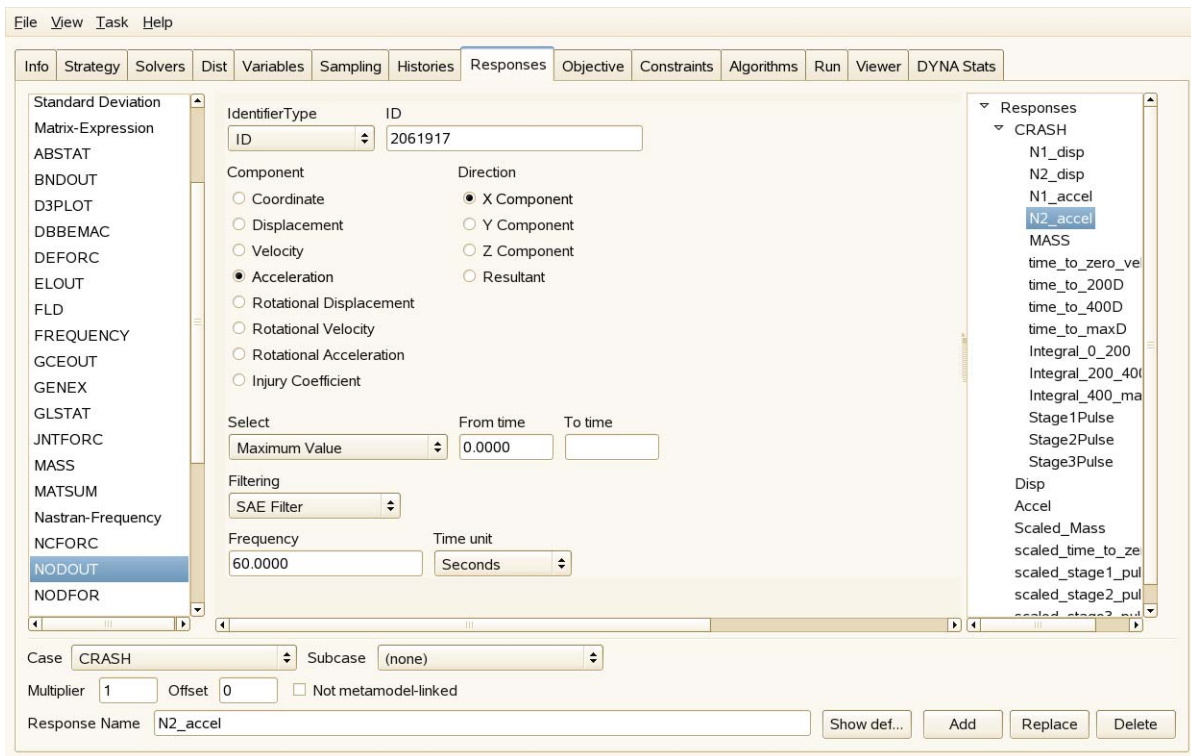


The default is the metamodel specified in Section 13.1. FF refers to the feedforward neural network approximation method (see Section 3.1).

*Example:*

```
response 'Displacement' kriging
```

In LS-OPT<sub>ui</sub>, responses are defined in the Responses panel (Figure 14-2):



**Figure 14-2: Responses panel in LS-OPT<sub>ui</sub>**

## 14.4. Extracting history and response quantities: LS-DYNA

In LS-OPT the general functionality for reading histories and responses from the simulation output is achieved through the `history` and `response` definitions (see Section 14.1 and Section 14.1.1 respectively). The syntax for the extraction commands for LS-DYNA responses and histories is identical, except for the selection attribute. The history function is included so that operations (such as subtracting two histories) can first be performed, after which a scalar (such as maximum over time) can be extracted from the resulting history.

There are two types of interfaces:

1. Standard LS-DYNA result interfaces. This interface provides access to the LS-DYNA binary databases (`d3plot` or `Binout`). The interface is an integral part of LS-OPT.

2. User specified interface programs. These can reside anywhere. The user specifies the full path.

Aside of the standard interfaces that are used to extract any particular data item from the database, specialized responses for metal-forming are also available. The computation and extraction of these secondary responses are discussed in Section 14.9.

The user must ensure that the LS-DYNA program will provide the output files required by LS-OPT.

As multiple result output sets are generated during a parallel run, the user must be careful not to generate unnecessary output. The following rules should be considered:

- To save space, only those output files that are absolutely necessary should be requested.
- A significant amount of disk space can be saved by judiciously specifying the time interval between outputs (DT) e.g., in many cases, only the output at the final event time may be required. In this case the value of DT can be set slightly smaller than the termination time.
- The result extraction is done immediately after completion of each simulation run. Database files can be deleted immediately after extraction if requested by the user (`clean` file (see also Section 9.9)).
- If the simulation runs are executed on remote nodes, the responses of each simulation are extracted on the remote node and transferred to the local run directory.

For more specialized responses the Perl programs provided can be used as templates for the development of own routines.

All the utilities can be specified through the command:

```
response response_name {scale_factor offset } command_line.
```

or

```
history history_name command_line.
```

## 14.5. LS-DYNA Binout results

From Version 970 of LS-DYNA the ASCII output can be written to a binary file: the `Binout` file.

The LS-PREPOST Binout capability can be used for the graphical exploration and troubleshooting of the data.

The response options are an extension of the history options – a history will be extracted as part of the response extraction.

### 14.5.1. Binout histories

Results can be extracted for the whole model or a finite element entity such as a node or element. For shell and beam elements the through-thickness position can be specified as well.

#### Command file syntax:

```
BinoutHistory -res_type res_type {-sub sub} -cmp component {-
invariant invariant -frame frame -id id (-name name) (-idi id)
(-namei name) -localid id1 id2 id3 (-localname name1 name2
name3) -pos position -side side}
```

Item	Description	Default	Remarks
<i>res_type</i>	Result type name	-	1
<i>sub</i>	Result subdirectory	-	1
<i>cmp</i>	Component of result	-	2
<i>invariant</i>	Invariant of results. Only MAGNITUDE is currently available.	-	3
<i>id</i>	ID number of entity	-	
<i>name</i>	Description (heading) of entity used as label	-	4
<i>pos</i>	Through thickness shell position at which results are computed.	1	5
<i>side</i>	Interface side for RCFORC data. MASTER or SLAVE.	SLAVE	
<i>frame</i>	GLOBAL GLOBAL_IN_REF LOCAL	GLOBAL	6
<i>localid</i>	3 Nodal ID's to define local coordinate axes	-	7
<i>localname</i>	3 Nodal names (headings) to define local coordinate axes	-	7
<i>id i</i>	Multiple ID's $i = 1,2,3, \dots n$	-	8
<i>name i</i>	Multiple headings as labels $i = 1,2,3, \dots n$	-	8

#### Example:

```
history 'ELOUT1' "BinoutHistory -res_type Elout -sub shell -cmp sig_xx
-id 1 -pos 1"
history 'invarHis' "BinoutHistory -res_type nodout -cmp displacement
-invariant MAGNITUDE -name RAIL15"
```

#### Remarks:

1. The result types and subdirectories are as documented for the \*DATABASE\_OPTION LS-DYNA keyword.
2. The component names are as listed in **Appendix A: LS-DYNA Binout Result Components**.
3. The individual components required to compute the invariant will be extracted automatically; for example, “-cmp displacement -invariant MAGNITUDE” will result in the automatic extraction of the  $x$ ,  $y$  and  $z$  components of the displacement.

4. The option “*-name*” that allows using the description/heading/name of the entity is valid only with *nodout* and *Elout* result types.
5. For the *shell* and *thickshell* strain results the upper and lower surface results are written to the database using the component names such as *lower\_eps\_xx* and *upper\_eps\_xx*.
6. Distances and deformations can be computed in global coordinates, local coordinates or global coordinates in reference frame ( $t = 0$ ), e.g. *-frame GLOBAL\_IN\_REF*. See Section 14.10.
7. The definition of a local coordinate system requires three reference nodes to define the system. These can be defined as integer ID’s or as names labels (headings) for example *-localid 231 556 722* or *-localname Thirdnode xBegin xEnd*. The second and third nodes define the direction of the local *x*-axis.
8. Some entities such as deformations or distances require multiple node definitions (two in the case of deformation or distance), e.g. *-id1 529 -id2 718* or *-name1 Measured\_node -name2 Reference\_node*.

### Averaging, filtering, and slicing Binout histories

These operations will be applied in the following order: averaging, filtering, and slicing.

#### Command file syntax:

---

```
BinoutHistory {history_options} {-filter filter_type
-filter_freq filter_freq -units units -ave_points ave_points
-start time start_time -end time end_time }
```

---

Item	Description	Default
<i>history_options</i>	All available history options	-
<i>filter_type</i>	Type of filter to use: SAE or BUTT	-
<i>filter_freq</i>	Filter frequency	60 cycles / time unit
<i>units</i>	S=seconds MS=milliseconds	S
<i>ave_points</i>	Number of points to average	-
<i>start_time</i>	Start time of history interval to extract using slicing	0
<i>end_time</i>	End time of history interval to extract using slicing	$t_{max}$

#### Example:

```
history 'ELOUT12' "BinoutHistory -res_type Elout -sub shell -cmp sig_xx
-name RAIL15 -pos 2 -filter SAE -start_time 0.02 -end_time 0.04"
history 'nodHist432acc_AVE' "BinoutHistory -res_type nodout
-cmp x_acceleration -id 432 -ave_points 5"
```

### 14.5.2. Binout responses

A response is extracted from a history – all the history options are therefore applicable and options required for histories are required for responses as well.

**Command file syntax:**


---

```
BinoutResponse {history_options} -select selection
```

---

Item	Description	Default	Remarks
<i>history_options</i>	All available history options including averaging, filtering, and slicing.	-	
<i>selection</i>	MAX   MIN   AVE   TIME	TIME	1

**Example:**

```
response 'eTime' "BinoutResponse -res_type glstat -cmp kinetic_energy
-select TIME -end_time 0.015"
$
response 'nodeMax' "BinoutResponse -res_type nodout -cmp x_acceleration -id 432
-select MAX -filter SAE -filter_freq 10"
```

*Remarks:*

1. The maximum, minimum, average, or value at a specific time must be selected. If selection is TIME, the *end\_time* history value will be used. If *end\_time* is not specified, the last value (end of analysis) will be used.

**Binout injury criteria**

Injury criteria such as HIC can be specified as the result component. The acceleration components will be extracted, the magnitude computed, and the injury criteria computed from the acceleration magnitude history.

**Command file syntax:**


---

```
BinoutResponse {history_options} -cmp cmp { -units units
-lengthunits lengthunits}
```

---

Item	Description	Default
<i>history_options</i>	All available history options including filtering and slicing.	-
<i>cmp</i>	HIC15, HIC36, or CSI	-
<i>lengthunits</i>	METER=meter MM=millimeter	METER
<i>units</i>	S=seconds MS=milliseconds	S

*Note:*

1. The length and time units are used to compute the gravity value based on  $9.81 \text{ m/s}^2$

**Example:**

```
response 'HIC_ms' 1 0 "BinoutResponse -res_type Nodout -cmp HIC15 -lengthunits
MM -units MS -name RAIL15"
```

## 14.6. LS-DYNA D3Plot results

The D3Plot interface is related to the Binout interface. The D3Plot commands differ from the Binout commands in that a response or history can be collected over a whole part. For example, the maximum stress in a part or over the whole model.

The available results types and components are listed in **Appendix A**.

The LS-PREPOST fringe plot capability can be used for the graphical exploration and troubleshooting of the data.

The response options are an extension of the history options – a history will be extracted as part of the response extraction.

### 14.6.1. D3Plot histories

Results can be extracted for the whole model or a finite element entity such as a node or element. For shell and beam elements the through-thickness position can be specified as well.

#### Command file syntax:

```
D3PlotHistory -res_type res_type {-sub sub} -cmp component {-
id id -pos position -pids part_ids -loc ELEMENT|NODE -
select_in_region selection -coord x y z -setid setid -tref
ref_state}
```

Item	Description	Default	Remarks
<i>res_type</i>	Result type name	-	1
<i>cmp</i>	Component of result	-	1
<i>id</i>	ID number of entity	-	2
<i>pos</i>	Through thickness shell position	1	
<i>pids</i>	One or more part ids.	-	3
<i>loc</i>	Locations in model. ELEMENT or NODE.	-	4
<i>select_in_region</i>	MAX MIN AVE	-select	5
<i>coord</i>	Coordinate of a point for finding nearest element	-	6
<i>tref</i>	Time of reference state for finding nearest element	0.0	6
<i>setid</i>	ID of *SET SOLID GENERAL in LS-DYNA keyword file	-	6

#### Example:

```
history 'ELOUT1' "D3PlotHistory -res_type Elout -sub shell -cmp sig_xx
-id 1 -pos 1"
history 'invarHis' "D3PlotHistory -res_type nodout -cmp displacement
-invariant MAGNITUDE -id 432"
history 'd3ploth4' "D3PlotHistory -res_type ndv -cmp x_displacement -pids 2 3 -
select_in_region MAX"
```

**Remarks:**

1. The result types and components are similar to what is used in LS-PREPOST. The result types and component names are listed in **Appendix A:LS-DYNA D3Plot Result Components**.
2. For histories, the *-id* option is mutually exclusive with the *-select\_in\_region* option.
3. If part ids are specified, the extraction will be done over these parts only. If no part ids and no element or node id are specified, then the extraction will be done considering the whole model.
4. Element results such as stresses will be averaged in order to create the NODE results. Nodal results such as displacements cannot be requested as ELEMENT results.
5. The maximum, minimum, or average over a part can be selected. The *-select\_in\_region* option is mutually exclusive with the *-id* option. The default value is that of the d3plot response *-select* argument which in turn defaults to MAX.
6. An *x,y,z* coordinate can be selected. The quantity will be extracted from the element nearest to *x,y,z* at time *tref*. Only elements included in the \*SET\_SOLID\_GENERAL element set are considered (only the PART and ELEMENT options).

**Slicing D3Plot histories**

Slicing of D3Plot histories is possible. Averaging and filtering are not available for D3Plot results.

**Command file syntax:**


---

```
D3PlotHistory {history_options} {-start_time start_time -
end_time end_time }
```

---

Item	Description	Default
<i>history_options</i>	All available history options	-
<i>start_time</i>	Start time of history interval to extract using slicing	0
<i>end_time</i>	End time of history interval to extract using slicing	$t_{max}$

**Example:**

```
history 'ELOUT12' "D3PlotHistory -res_type stress -cmp xx_stress
-id 1 -pos 2 -start_time 0.02 -end_time 0.04"
```

**D3Plot FLD results**

If FLD results are requested then the FLD curve can be specified using (i) the *t* and *n* coefficients or (ii) a curve in the LS-DYNA input deck. The interpretation of the *t* and *n* coefficients is the same as in LS-PREPOST.

**Command file syntax:**


---

```
D3PlotHistory {history_options} {-fld_t fld_t -fld_n fld_n -  
fld_curve fld_curve}
```

---

Item	Description	Default
<i>history_options</i>	All available history options	-
<i>fld t</i>	Fld curve t coefficient	-
<i>fld n</i>	Fld curve t coefficient	-
<i>fld_curve</i>	ID of curve in the LS-DYNA input deck	-

**Example:**

```
history 'ELOUT12' "D3PlotHistory -res_type stress -cmp xx_stress  
-id 1 -pos 2 -start_time 0.02 -end_time 0.04"
```

**14.6.2. D3Plot responses**

A response is extracted from a history – all the history options are therefore applicable and options required for histories are required for responses as well.

**Command file syntax:**


---

```
D3PlotResponse {history_options} -select selection
```

---

Item	Description	Default	Remarks
<i>history_options</i>	All available history options	-	
<i>select</i>	MAX MIN AVE TIME	TIME	1

**Example:**

```
Response •nodeMax• "D3PlotResponse -res_type ndv -cmp x_displacement -id 432 -  
select MAX"
```

*Remarks:*

- The maximum, minimum, average, or value at a specific time must be selected. If *select* is TIME then the *end\_time* history value will be used. If *end\_time* is not specified, the last value (end of analysis) will be used. If the selection must be done over parts as well, then this option is used together with the *-select\_in\_region* argument as documented for d3plot histories; firstly the maximum, minimum, or average value will be selected for the part as specified by the *-select\_in\_region* argument, followed by the selection of the maximum, minimum, or average over time as specified by the *-select* argument.



## 14.7. Mass

Command file syntax:

---

```
DynaMass p1 p2 p3 ... pn mass_attribute
```

---

*Table 14-4: Mass item description*

Item	Description
<i>p1 ... pn</i>	Part numbers of the model. Omission implies the entire model.
<i>Mass attribute</i>	Type of mass quantity (see table below).

*Table 14-5: Mass attribute description*

Attribute	Description
MASS	Mass
I11	Principal inertias
I22	
I33	
IXX	Components of inertia tensor
IXY	
IXZ	
IYX	
IYY	
IYZ	
IZX	
IZY	
IZZ	
X_COORD	<i>x</i> -coordinate of mass center
Y_COORD	<i>y</i> -coordinate of mass center
Z_COORD	<i>z</i> -coordinate of mass center

*Example:*

```
$ Specify the mass of material number 13, 14 and 16 as
$ the response 'Component_mass'.
response 'Component_mass' "DynaMass 3 13 14 16 Mass"
$ Specify the total principal inertial moment about the x-axis.
response 'Inertia' "DynaMass Ixx"
```

*Remarks:*

1. The output file d3hsp must be produced by LS-DYNA.

- Values are summed if more than one part is specified (so only the mass value will be correct). However for the full model (part specification omitted) the correct values are given for all the quantities.

## 14.8. Frequency and mode tracking

**Command file syntax:**

---

DynaFreq mode\_original modal\_attribute tracking\_option

---

**Table 14-6: Frequency item description**

Item	Description
<i>mode_original</i>	The number (sequence) of the baseline modal shape to be tracked.
<i>modal_attribute</i>	Type of modal quantity. (See table below).
<i>tracking_option</i>	Disable mode tracking using <code>-notrack</code> , otherwise leave blank

**Table 14-7: Frequency attribute description**

Attribute	Description
FREQ	Frequency of current mode corresponding in modal shape to baseline mode specified.
NUMBER	Number of current mode corresponding in modal shape to baseline mode specified.
GENMASS	Modal assurance criterion. $\max_j \frac{\{\varphi_0\}^H \{\varphi_j\} \{\varphi_j\}^H \{\varphi_0\}}{\{\varphi_0\}^H \{\varphi_0\} \{\varphi_j\}^H \{\varphi_j\}} = \max_j MAC_j$

**Theory:** Mode tracking is required during optimization using modal analyses as mode switching (a change in the sequence of modes) can occur as the optimizer modifies the design variables. In order to extract the frequency of a specified mode, LS-OPT calculates the modal assurance criterion (*MAC*). The scalar *MAC* value provides the degree of consistency between baseline modal shape and each mode shape of the current design. The maximum *MAC* value indicates the mode most similar in shape to the original mode selected. LS-OPT reads the eigenvectors from the `d3eigv` files, for calculating the *MAC* values. The *MAC* value for the reference modal vector  $\varphi_0$  and the  $j^{th}$  modal vector of the current design  $\varphi_j$  is calculated as:

$$MAC_j = \frac{\{\varphi_0\}^H \{\varphi_j\} \{\varphi_j\}^H \{\varphi_0\}}{\{\varphi_0\}^H \{\varphi_0\} \{\varphi_j\}^H \{\varphi_j\}} \tag{14-9}$$

where *H* is the Hermitian operator. The *MAC* value corresponding to the most similar mode can be extracted with the GENMASS attribute (see Table 14-7).

*Example:*

```
$ Obtain the frequency of the current mode corresponding to the
$ baseline mode shape number 15 as the response 'Frequency'.
response 'Frequency' "DynaFreq 15 FREQ"
$ Obtain the number (sequence) of the current mode corresponding to
$ the baseline mode shape number 15 as the response 'Number of mode'.
response 'Modal number' "DynaFreq 15 NUMBER"
```

In certain cases, the user may be interested in the frequency corresponding to a specific mode number. To enable this option, the ability to turn mode tracking off is provided in the “Responses” panel of the GUI. By default this feature is on, but turning it off enables one to extract the responses corresponding to a specific mode number, irrespective of the mode shape.

*Example:*

```
$ Obtain the frequency of the mode number 15 as the response 'Frequency'.
response 'Frequency' "DynaFreq 15 FREQ -notrack"
```

*Remarks:*

1. All LS-DYNA versions are supported.
2. The user must identify which baseline mode is of interest by viewing the baseline `d3eigv` file in LS-PrePost. The baseline mode number should be noted.
3. The optimization run can now be started with the correct `DynaFreq` command (or select the Baseline Mode Number in the GUI).
4. `mode_original` cannot exceed 999.

## 14.9. Extracting metal forming response quantities: LS-DYNA

Responses directly related to sheet-metal forming can be extracted, namely the final sheet thickness (or thickness reduction), Forming Limit criterion and principal stress. All the quantities can be specified on a part basis as defined in the input deck for LS-DYNA. Mesh adaptivity can be incorporated into the simulation run.

The user must ensure that the `d3plot` files are produced by the LS-DYNA simulation. Note that the `D3plotResponse` commands are an alternative.

### 14.9.1. Thickness and thickness reduction

Either thickness or thickness reduction can be specified as follows.

**Command file syntax:**


---

```
DynaThick [THICKNESS|REDUCTION] p1 p2 ... pm [MIN|MAX|AVE]
```

---

*Table 14-8: DynaThick item description*

Item	Description
THICKNESS	Final thickness of part
REDUCTION	A percentage thickness reduction of the part
$p1...pn$	The parts as defined in LS-DYNA. If they are omitted, all the parts are used.
MIN   MAX   AVE	Minimum, maximum or average computed over all the elements of the selected parts

Example:

Response 'Thickness 1' "DynaThick THICK 1 2 MAXIMUM"

Response 'Thickness 1' "DynaThick REDU 1 2 MINIMUM"

### 14.9.2. FLD constraint

The FLD constraint is shown in Figure 14-3. Two cases are distinguished for the FLD constraint.

- The values of some strain points are located above the FLD curve. In this case the constraint is computed as:

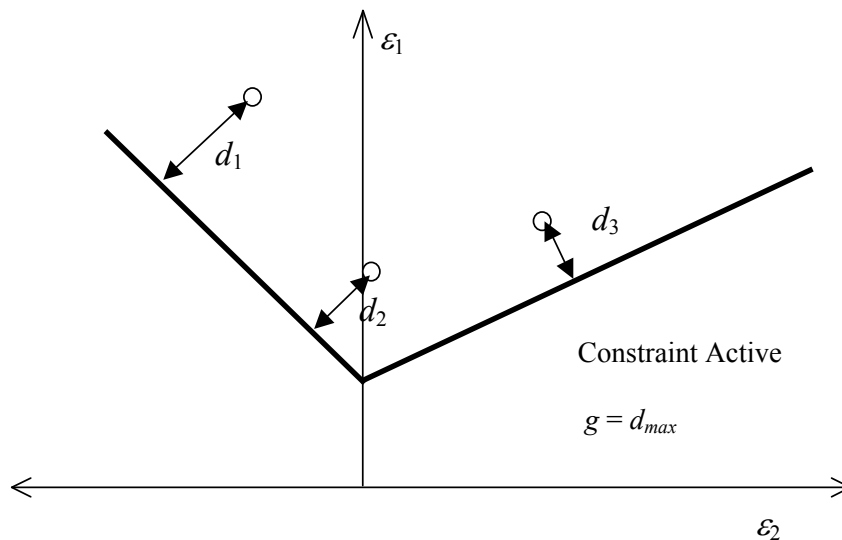
$$g = d_{max}$$

with  $d_{max}$  the maximum smallest distance of any strain point above the FLD curve to the FLD curve.

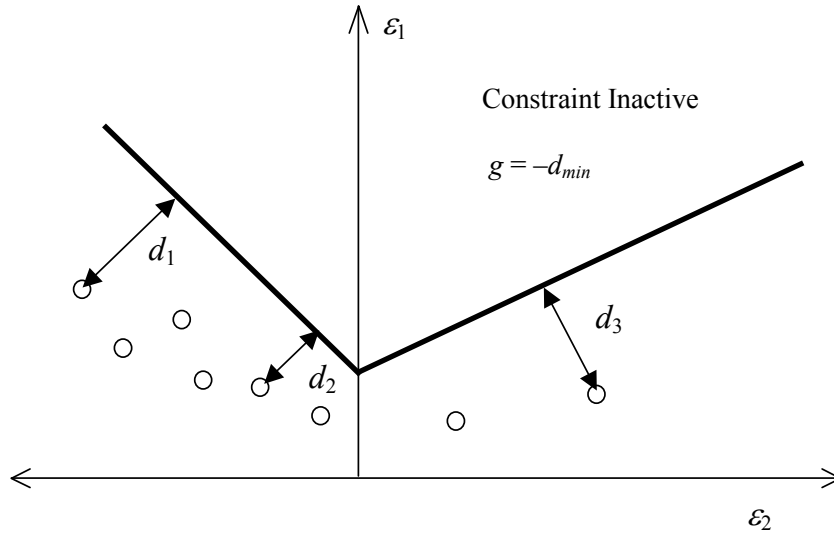
- All the values of the strain points are located below the FLD curve. In this case the constraint is computed as:

$$g = -d_{min}$$

with  $d_{min}$  the minimum smallest distance of any strain value to the FLD curve (Figure 14-3).



a) FLD Constraint active



**b) FLD Constraint inactive**

**Figure 14-3: FLD curve – constraint definition**

It follows that for a feasible design the constraint should be set so that  $g(\mathbf{x}) < 0$ .

**Bilinear FLD constraint**

The values of both the principle upper and lower surface in-plane strains are used for the FLD constraint.

**Command file syntax:**

---

DynaFLD p1 p2 ... pn intercept negative\_slope positive\_slope

---

The following must be defined for the model and FLD curve:

**Table 14-9: DynaFLD item description**

Item	Description
<i>p1...pn</i>	Part numbers of the model. Omission implies the entire model.
<i>intercept</i>	The FLD curve value at $\epsilon_2 = 0$
<i>negative_slope</i>	The absolute value of the slope of the FLD curve value at $\epsilon_2 < 0$
<i>positive_slope</i>	The absolute value of the slope of the FLD curve value at $\epsilon_2 > 0$

*Example:*

```
$ Specify the FLD Constraint to be used
Response 'FLD' "DynaFLD 1 2 3 0.25 1.833 0.5"
```

## General FLD constraint

A more general FLD criterion is available if the forming limit is represented by a general curve. Any of the upper, lower or middle shell surfaces can be considered.

*Remarks:*

1. A piece-wise linear curve is defined by specifying a list of interconnected points. The abscissae ( $\square 2$ ) of consecutive points must increase (or an error termination will occur). Duplicated points are therefore not allowed.
2. The curve is extrapolated infinitely in both the negative and positive directions of  $\square 2$ . The first and last segments are used for this purpose.
3. The computation of the constraint value is the same as shown in (Figure 14-3).

### Command file syntax:

---

```
DynaFLDg [LOWER | CENTER | UPPER] p1 p2 ... pn load_curve_id
```

---

The following must be defined for the model and FLD curve:

**Table 14-10: DynaFLDg item description**

Item	Description
LOWER	Lower surface of the sheet
UPPER	Upper surface of the sheet
CENTER	Middle surface of the sheet
<i>p1...pn</i>	Part numbers of the model. Omission implies the entire model.
<i>load_curve_id</i>	Identification number of a load curve in the LS-DYNA input file. The *DEFINE_CURVE keyword must be used. Refer to the LS-DYNA User's Manual for an explanation of this keyword.

*Example:*

```
$ Specify the general FLD Constraint to be used
Response 'FLDL' "DynaFLDg LOWER 1 2 3 23"
Response 'FLDU' "DynaFLDg UPPER 1 2 3 23"
Response 'FLDC' "DynaFLDg CENTER 23"
```

For all three specifications load curve 23 is used. In the first two specifications, only parts 1, 2 and 3 are considered.

*Remarks:*

1. The interface program produces an output file `FLD_curve` which contains the  $\varepsilon_1$  and  $\varepsilon_2$  values in the first and second columns respectively. Since the program first looks for this file, it can be specified in lieu of the keyword specification. *The user should take care to remove an old version of the `FLD_curve` if the curve specification is changed in the keyword input file.* If a structured input file is used for LS-DYNA input data, `FLD_curve` *must* be created by the user.
2. The scale factor and offset values feature of the `*DEFINE_CURVE` keyword are not utilized.

**14.9.3. Principal stress**

Any of the principal stresses or the mean can be computed. The values are nodal stresses.

**Command file syntax:**


---

```
DynaPStress [S1 | S2 | S3 | MEAN] p1 p2 . . . pn [MIN | MAX | AVE]
```

---

**Table 14-11: DynaPStress item description**

Item	Description
S1, S2, S3	$\sigma_1, \sigma_2, \sigma_3$
MEAN	$(\sigma_1 + \sigma_2 + \sigma_3)/3$
p1 ... pn	Part numbers of the model. Omission implies the entire model.
MIN   MAX   AVE	Minimum, maximum or average computed over all the elements of the selected parts

*Example:*

```
Response 'Stress 1' "DynaPStress MEAN 14 17 MAX"
```

**14.10. Kinematics**

Additional kinematics such as *distances* and *deformations* can be computed directly using NODOUT results by defining two nodes on the finite element mesh. Kinematics consist of two main quantities:

1. The distance vector  $\mathbf{q}$  computed using the differences between the coordinates of the two nodes.
2. The deformation derived using the difference between the distance vector computed at time  $t$  and the original distance vector ( $t = 0$ ).

These quantities can be computed in

1. the global coordinate system,
2. a local coordinate system or
3. local coordinates referred to the global reference frame ( $t = 0$ ).

1. The local axes are computed using the convention defined in Section 14.14.2 to define the rotation matrix  $\mathbf{A}$  where  $\mathbf{A}$  is a function of time. The quantities are therefore defined as follows.

**Table 14-12: Definitions of the kinematics of a displaced rigid body**

Frame	Distance	Deformation
Global	$\mathbf{d} = \mathbf{q}$	$\mathbf{u} = \mathbf{q} - \mathbf{q}(0)$
Local	$\mathbf{d}' = \mathbf{A}(t)\mathbf{q}(t)$	$\mathbf{u}' = \mathbf{A}(t)\mathbf{q}(t) - \mathbf{A}(0)\mathbf{q}(0)$
Local in reference	$\mathbf{d}'' = \mathbf{A}^T(0)\mathbf{A}(t)\mathbf{q}(t)$	$\mathbf{u}'' = \mathbf{A}^T(0)\mathbf{A}(t)\mathbf{q}(t) - \mathbf{q}(0)$

The orthogonal matrix  $\mathbf{A}(t)$  is defined by a local coordinate system ( $x'y'z'$  in Figure 14-4) which in turn is defined by three nodes on the finite element mesh as it displaces over time. Nodes **2** and **3** represent the local  $x$ -axis direction (see Figure 14-4) while Node **1** represents the third node. This is the same convention as defined in Section 14.14.2.

The second and third kinematic categories are both denoted “local” since deformation should be totally absent for pure rigid body systems.

If the triangles 1-2-3 and 1'-2'-3' are congruent (i.e. they represent a rigid body), the quantity defined as *Local in reference frame* is invariant with respect to the node numbering. E.g. the triplets (1, 2, 3), (2, 3, 1) or (1, 3, 2) should yield the same value.

To monitor congruence, A *Congruence ratio* for each history or response is displayed in the lognnnn (run directory) or Isopt\_output files. The ratio for a node is defined as the ratio of the side length opposite the node  $i$  at time  $t_{final}$  divided by the same quantity applied to the undeformed structure (see equation below). Three values are therefore printed. The ideal ratio is unity, signifying a perfectly rigid body.

$$r_i = \frac{|\mathbf{x}_{i-1}(t) - \mathbf{x}_{i-2}(t)|}{|\mathbf{x}_{i-1}(0) - \mathbf{x}_{i-2}(0)|}, i = 1,2,3$$

Kinematic quantities are available as both histories and responses.



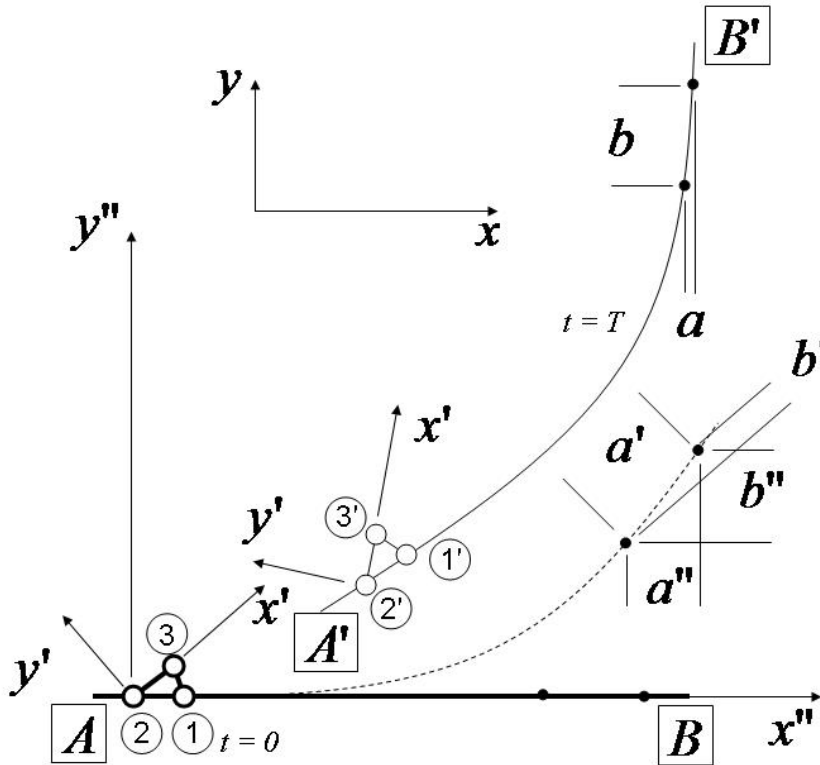


Figure 14-4: Local and global coordinate systems

Example:

```

response 'def_X' "BinoutResponse -res_type Nodout -cmp x_deformation -frame global
-id1 432 -id2 167 -select TIME "
response 'def_x' "BinoutResponse -res_type Nodout -cmp x_deformation -frame local
-id1 432 -id2 167 -localid 330 329 500 -select TIME"
response 'def_Xx' "BinoutResponse -res_type Nodout -cmp x_deformation -frame
global_in_ref -id1 432 -id2 167 -localid 330 329 500 -select TIME -end_time 0.0300"

history 'dist_X' "BinoutHistory -res_type nodout -cmp x_distance -frame global
-id1 432 -id2 167"
history 'dist_x' "BinoutHistory -res_type nodout -cmp x_distance -frame local
-id1 432 -id2 167 -localid 330 329 500"
history 'dist_Xx' "BinoutHistory -res_type nodout -cmp x_distance -frame
global_in_ref -id1 432 -id2 167 -localid 330 329 500"

history 'dist_resultant' "BinoutHistory -res_type nodout -cmp distance -invariant
MAGNITUDE -frame global -id1 432 -id2 167"
history 'def_resultant' "BinoutHistory -res_type nodout -cmp deformation -invariant
MAGNITUDE -frame global -id1 432 -id2 167"
history 'distance_globalref_x4' "BinoutHistory -res_type nodout -cmp x_distance
-frame global_in_ref -id1 432 -id2 167 -localid 500 329 330"

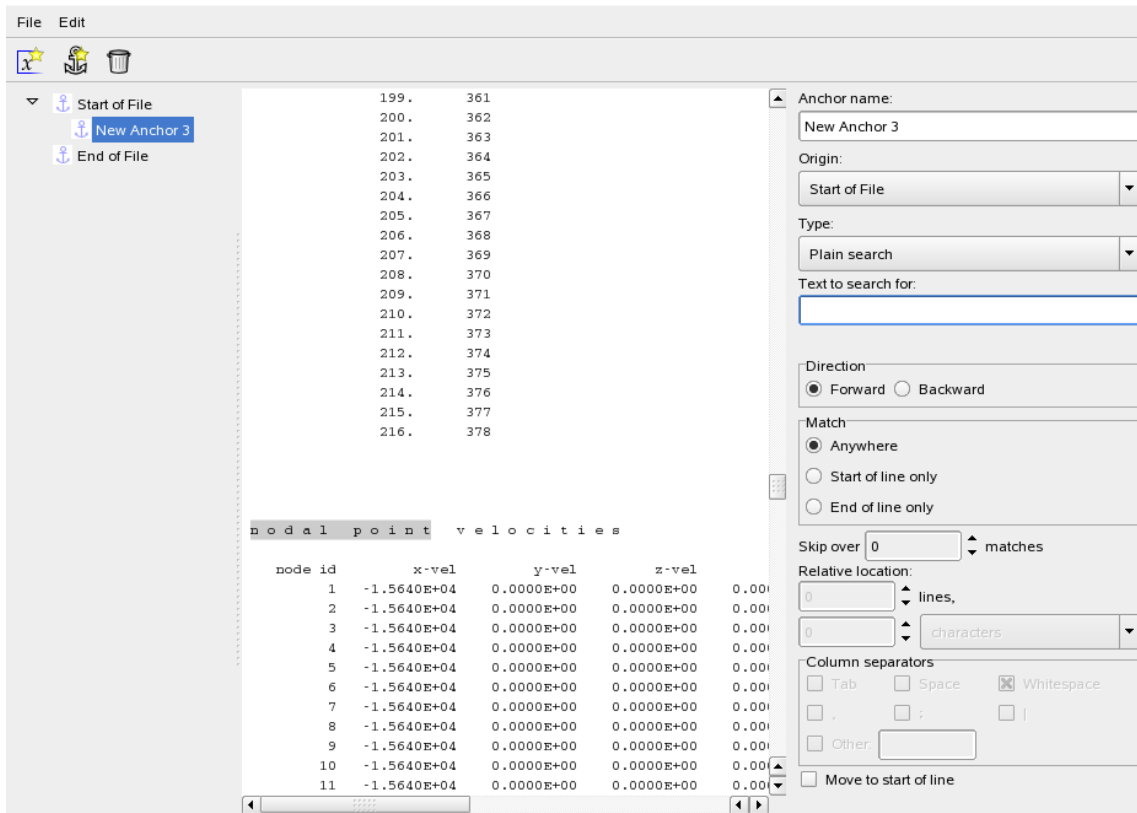
```

## 14.11. The GenEx application for extracting entities from a text file

*GenEx* (Generic Extractor) is a tool to create the .g6 file used by LS-OPT to extract responses and histories. It is included in the LS-OPT distribution as the executable file `genex`.

### 14.11.1. The main window

GenEx can be started from the command line by typing `genex <filename>` or by selecting the *Create/Edit* button after selecting GenEx on the **Responses** or **Histories** page.



When first starting GenEx, there will be two predefined anchors in the tree on the left, **Start of File** and **End of File**. It is not possible to change or remove these two anchors.

The middle part of the window displays the data file, with symbols for anchors and entities. The current entity/anchor will be highlighted or have a thin black border around it.

On the right is the dialog box for specifying/selecting options for the currently selected anchor/entity.

### Anchors

Anchors describe how to find a certain position in the data file. This can be done with searching for keywords or with an absolute position.

## Entities

An entity is a quantity we want to extract from LS-OPT. Entities describe both what the number should look like as well as where, relative to the parent, to find it. There are three types of entities, scalar, column and repeated anchor vectors (see “Options specific for entities” for the difference between them).

## Options

When an anchor or an entity is selected, it is possible to change the options shown in the dialog box. A new search will be performed whenever an option is changed that requires it. The only exception is the **Text to search for**, this requires the user to hit **Enter** (on the keyboard) to start the new search.

Origin

This is the parent anchor of the anchor/entity.

Column separator

If columns are selected in **Relative positions** it is possible to change what separates the columns in the input file.

## Options specific for anchors

*Type*

There are four types of searches. Three of them are keyword-based (search-phrase based).

1. **Plain text:** This is the most basic search. It looks for the given text in the file and positions the anchor in front of the match.
2. **Glob search:** The glob search main goal is to be able to match strings with the aid of the wild cards, '\*' and '?'. The asterisk matches any character any number of times and the question mark matches any character one time.

Example:

\*abc

will match any word ending with abc (xxxabc, yyyabc, etc.) and the anchor will be placed where the match begins ((A)xxxabc, (A)yyyabc).

a?c

will match all three letter words starting with 'a' and ending with 'c' (axc, a5c, etc.) and the anchor will be placed before the match begins ((A)axc, (A)a5c).

3. **Regular expression search:** The asterisk \* matches the preceding element zero or more times and the dot . matches any character one time. If letters are put inside brackets this matches any single character inside the brackets. If a '^' is put inside the brackets this means that we should match any character not inside the brackets.

Examples:

ab\*c

matches "ac", "abc", "abbbc", etc.

a.c

matches all three letter strings starting with 'a' and ending with 'c' (ahc, a8c, aHc, etc.)

[csad]bc

matches all strings starting with c, s, a or d followed by 'bc' (cbc, sbc, abc, and dbc).

[^csad]bc

matches all strings not starting with c, s, a or d followed by 'bc' (xbc, 5bc, kbc, etc.).

These can all be combined into a larger regular expression, "[skjfrdzh]\*esp[ohjd]n.e" will match "response" (but also "espdn1e" for example).

4. **Absolute search:** In this search the user positions the anchor simply by telling on which row and in which column the anchor is located in the file.

*Plain text*, *glob* and *regular expression* search searches for a specific text string. The absolute search positions the anchor relative to the parent. The *glob* and *regular expression* searches are very similar to the search capabilities in the Perl language or the Unix/Linux scripting language.

#### ***Text to search for***

This is the text/regular expression/glob to search for.

#### ***Direction***

Starting from the origin, this is the direction to search in.

#### ***Match***

This is where on the line the search text will have to match.

#### ***Relative Location***

When **Absolute search** is selected, this section will be enabled. Here it is possible to enter the absolute position of the anchor if known.

#### ***Skip over***

Since the input file can contain several instances of the search term it is possible to skip some of them to find the desired position.

#### ***Move to start of line***

When this is checked the anchor will be positioned at the start of the line, even if it is found somewhere else.

### **Options specific for entities**

#### ***Relative Location***

This is the position of the entity, relative to the parent anchor.

#### ***Type of entity***

Here there are three options, scalar, column vector and repeated anchor vector.

### *Scalar*

The scalar entity is used for extracting responses and it extracts one result.

### *Column vector*

A column vector extracts a column of data.

### *Repeated anchor vector*

A repeated anchor vector repeats the search of the selected anchor to extract several entities found in different places in the input file.

### *Number format*

Here it is possible to specify what a number looks like.

### *Maximum length*

The default behavior is that an entity starts at the specified position and ends with a white space. Here it is possible to specify the length of the entity if this is not the case.

### *Maximum number of components*

When using GenEx to extract histories the default behavior is to keep extracting until a match is not found, this option limits the number of extracted results.

### *Anchor to repeat*

If the entity type is “repeated anchor vector” this will show a menu with valid anchors. Start of file and End of file will not be available since they can’t be repeated.

## **14.11.2. Creating a .g6 file for LS-OPT**

First we have to select the input file in which to search. This is done from the **File** menu: **Select input file**. The file will be displayed in the middle window of the application.

### **Creating an anchor or entity**

There are three ways to create anchors or entities. The first is to select the anchor used as parent and then click on the anchor or entity button in the menu depending on what is needed. This will create a new uninitiated child. By selecting the new anchor or entity in the tree view on the left side, the options will be visible on the right side panel.

The second way is to simply make a selection in the text file, right click and select **Create Anchor Here** or **Create Entity Here**. This will create a new child at that position with the currently selected anchor as the parent anchor. It’s possible to select a column of numbers to create a column vector.

The third option is to make a selection in the text and drag that selection to the anchor we want to use as parent in the tree.

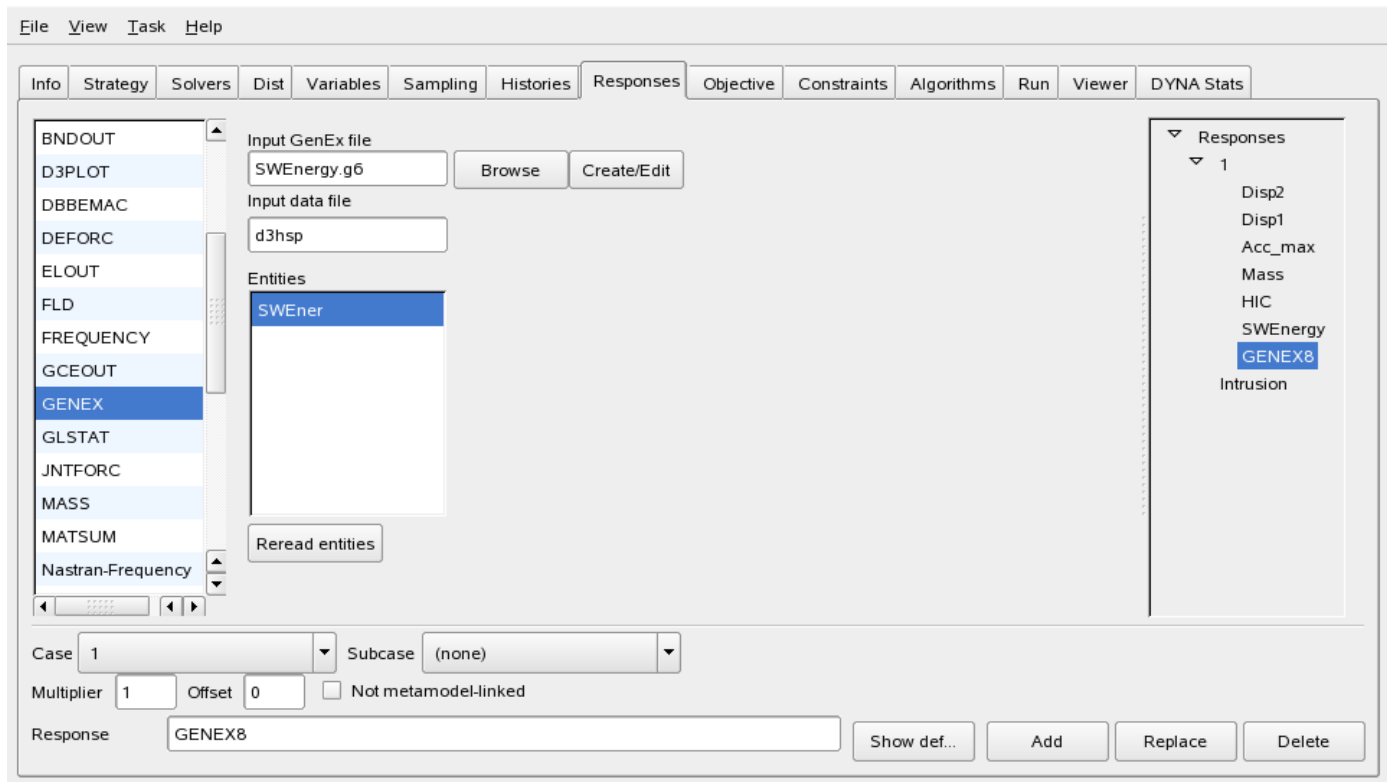
## Creating an .g6 file without an input file

It is possible to create a .g6 file without access to the input file we want to extract from. However, this requires some knowledge of the file format and syntax.

## Editing a .g6 file

From the “File” menu, select “Open GenEx file”.

### 14.11.3. How to use GenEx from LS-OPT for extracting responses



From the Responses panel select GENEX as a response. This will show a few options related to GenEx .

The first selection to be made is which .g6 file to use. The full path has to be specified. This option provides a list of available entities to choose from. The entities need to be of the “Scalar” type. It is also possible to edit a file by clicking the **Create/Edit** button. If no file name is given the default action is to create a new .g6 file.

Secondly, enter the name of the input data file. LS-OPT looks for the file in the run directory.

### 14.11.4. An example using GenEx to extract responses

This example explains how to extract a number of responses from the LS-DYNA d3hsp file. Different search options are employed to demonstrate the various options.

1. Open the GenEx GUI by selecting **Create/Edit**. Then select d3hsp as the input file by using **File**→**Select input file**. The d3hsp file is displayed in the middle. We are interested in 3 responses at various cycles and a fourth response to be the last one in the file.

Defining an anchor:

2. Define an anchor with the name `Cycle4800_Plain` by clicking on the anchor icon or using the **Edit** option.
3. Use a plain search to search for the string "dt of cycle 4800". If you want to change the string in the text box, remember to hit the "Enter" key on the keyboard. The anchor is displayed as a small anchor icon in the leftmost column of the line that matches the search string. The next step would be to find the desired field relative to this anchor.

The screenshot shows the GenEx GUI interface. On the left, a tree view shows the file structure with 'Cycle4800\_Plain' selected. The main window displays a log file with various energy and time metrics. A search box on the right is configured with the following settings:

- Anchor name: `Cycle4800_Plain`
- Origin: `Start of File`
- Type: `Plain search`
- Text to search for: `dt of cycle 4800`
- Direction: `Forward`
- Match: `Anywhere`
- Skip over: `0` matches
- Relative location: `0` lines, `0` characters
- Column separators: `Tab`, `Space`, `Whitespace`, `,`, `:`, `|`, `Other`

The search results in the log file show the following highlighted values:

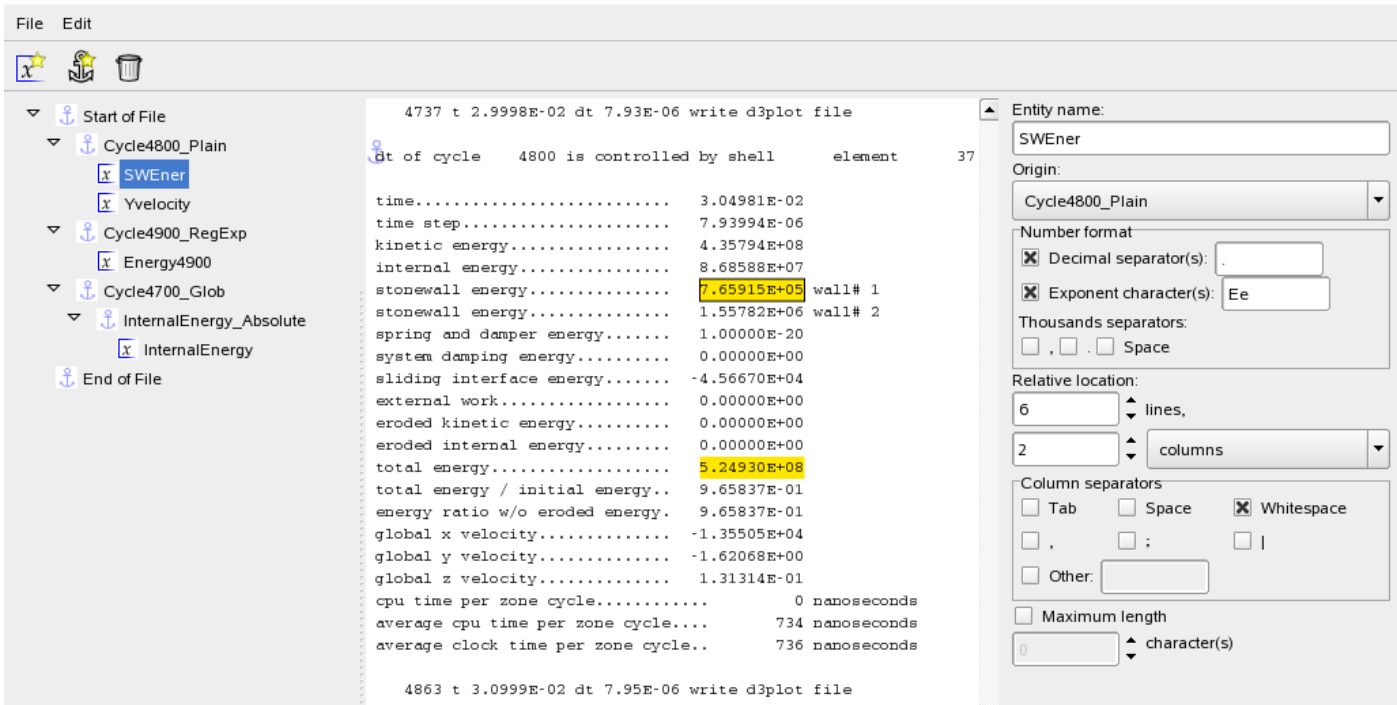
```

7.65915E+05 wall# 1
5.24930E+08

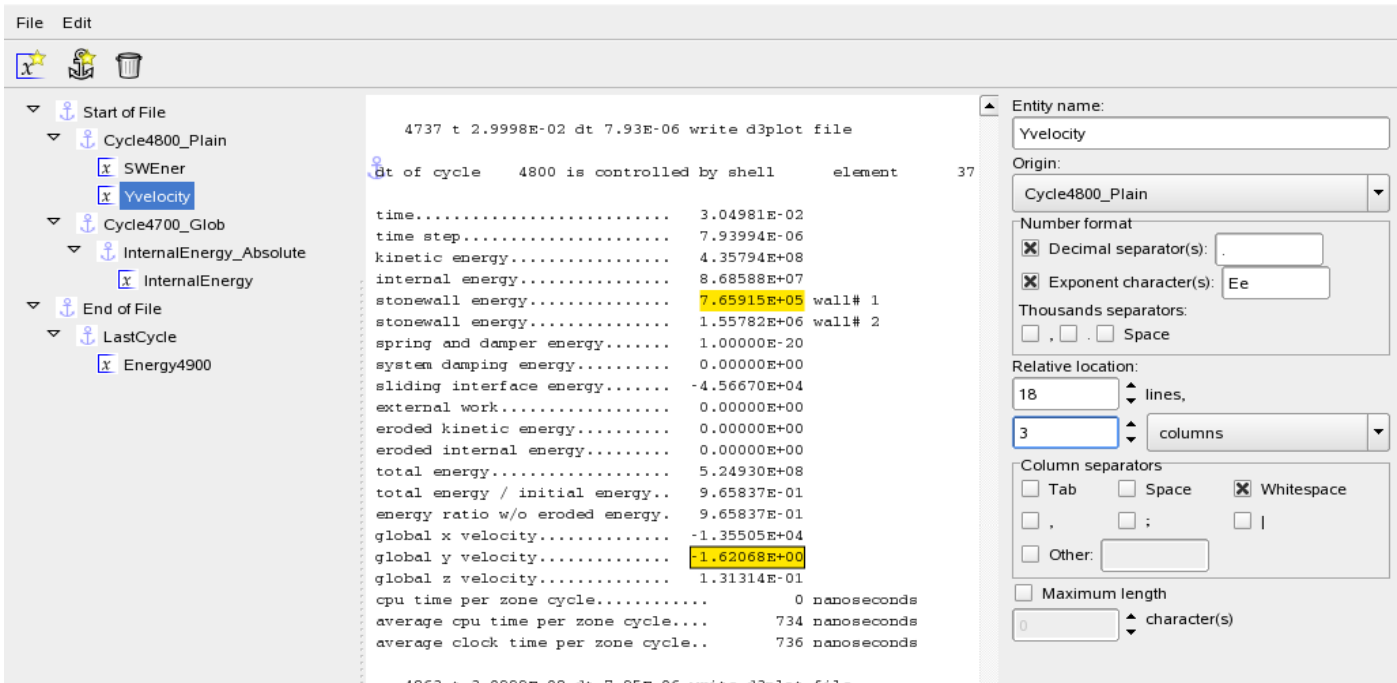
```

Defining an entity:

4. Define a new entity `SWEner` by using the leftmost **x**-icon or the **Edit** option.
5. Choose the previously defined anchor as the Origin.
6. Find the desired field by searching 6 lines below the anchor, 2 columns across. The desired field is displayed as highlighted in yellow with a black border. See figure below.

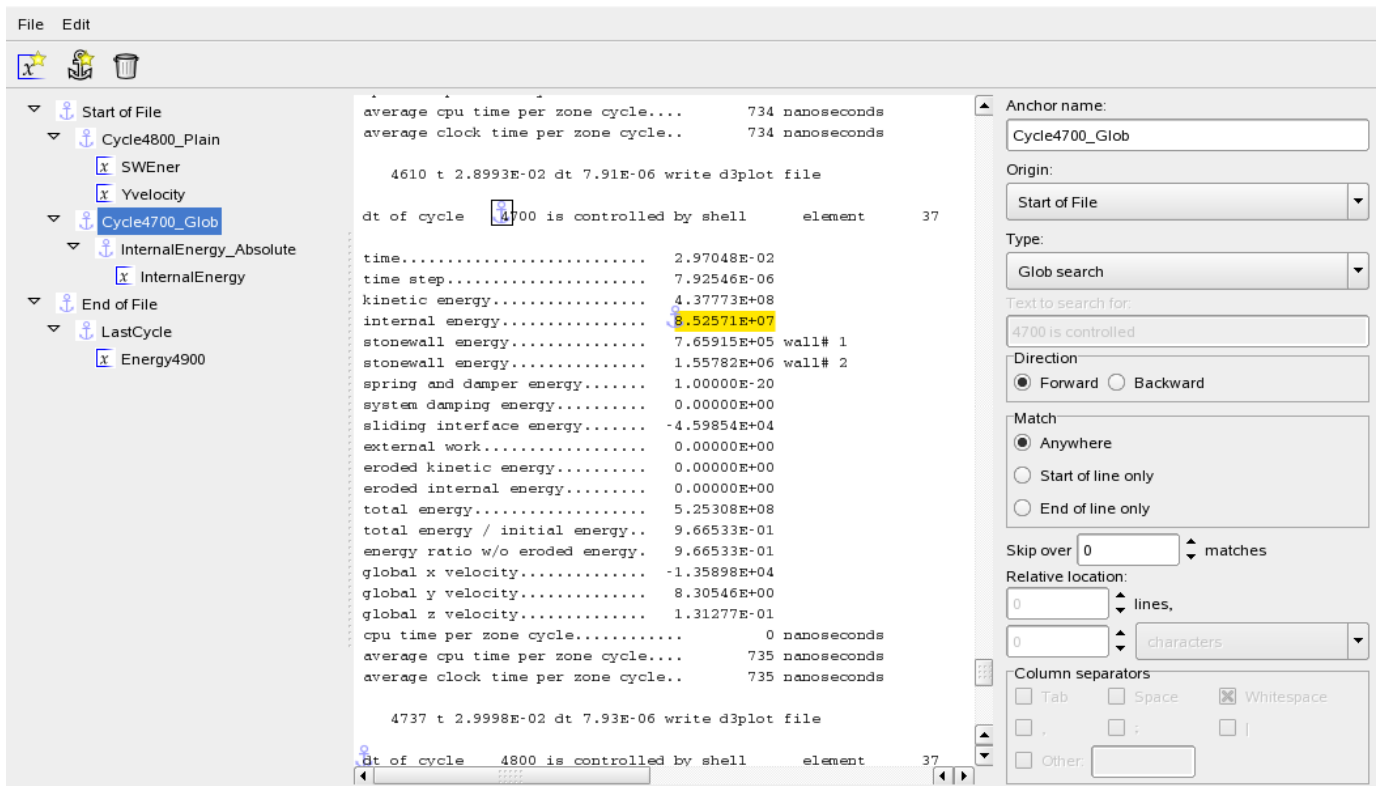


7. Now define a new entity referred to the same anchor `Cycle4800_Plain`. This entity is 18 lines below the anchor and 3 columns across as shown in the **Relative location** dialog below:

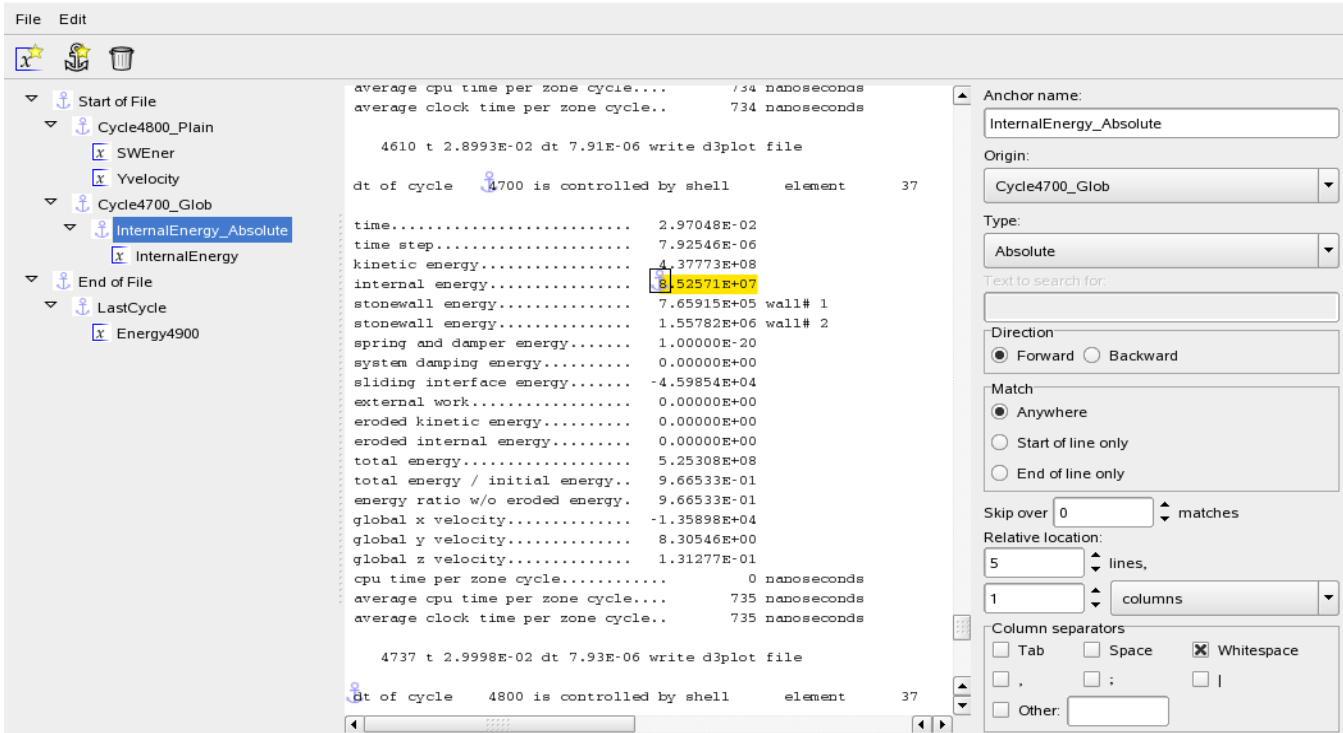


8. Define a second anchor using a global search for the string "4700 is controlled". The origin of this anchor is also the start of the file and the search is forward from that point. Note the anchor placement on the figure below just before the string "4700 is controlled".

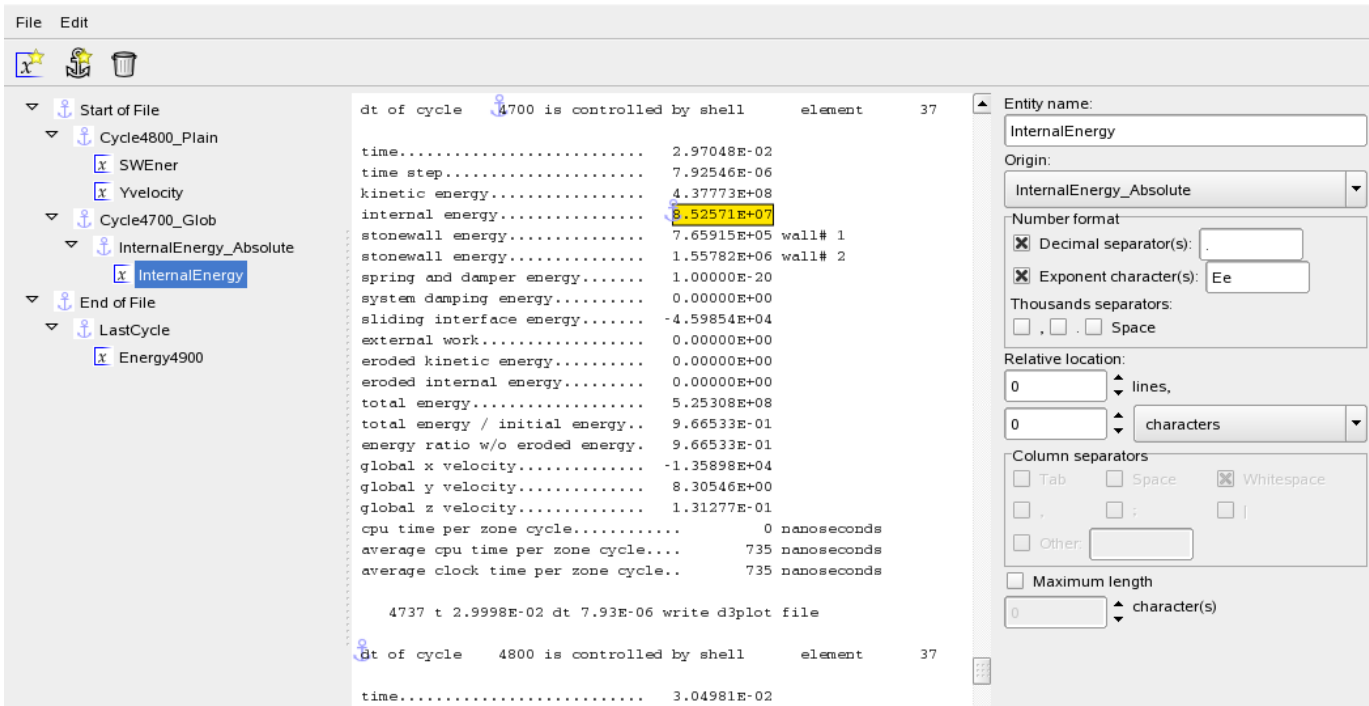




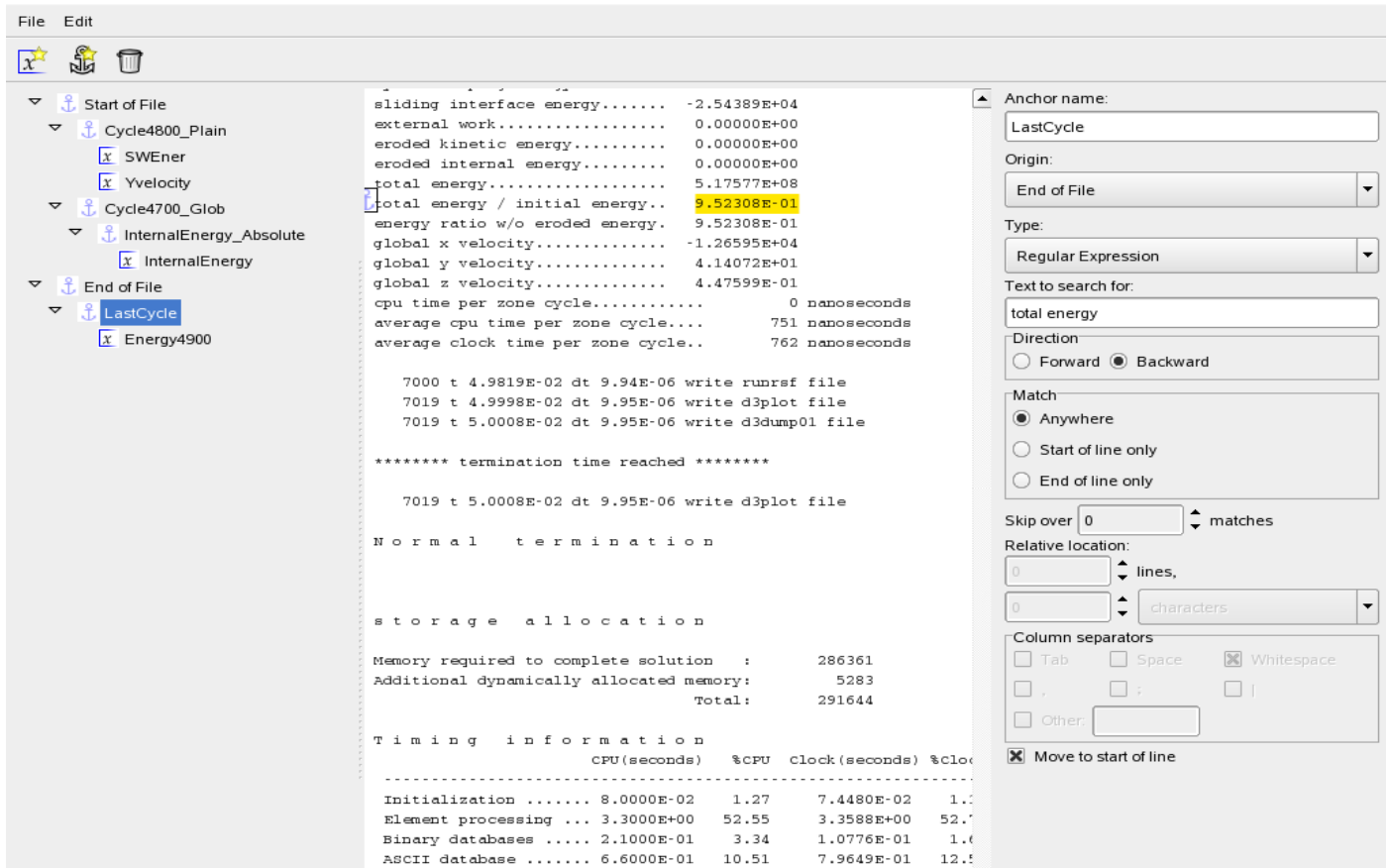
- Now define an anchor `InternalEnergy_Absolute` relative to the previous anchor by setting the origin as `Cycle4700_Glob`, then searching 5 lines down and one column across. Note the anchor icon just before the yellow-highlighted number in the figure below.



10. Define a new entity InternalEnergy using the InternalEnergy\_Absolute anchor as reference point. The desired field is immediately found since the anchor is already at the desired location.



11. The next desired entity is the final total energy ratio (i.e. the one in the last cycle in the file). In this case we will set the reference anchor called `LastCycle` to be the end of the file (Origin) and search backwards (Direction).
12. The search string is "total energy" and the regular expression search type is used. The settings to find the anchor are shown below.



13. The entity is found by using `LastCycle` as the anchor and searching in the sixth column. See **relative location** dialog box below.

The screenshot shows the LS-OPT GUI interface. On the left, a tree view shows the project structure with 'Energy4900' selected under 'LastCycle'. The main window displays the output of the GenEx setup, including energy values and termination time. The right pane shows the 'Entity name' field set to 'Energy4900' and various formatting options.

```

sliding interface energy..... -2.54389E+04
external work..... 0.00000E+00
eroded kinetic energy..... 0.00000E+00
eroded internal energy..... 0.00000E+00
total energy..... 5.17577E+08
total energy / initial energy.. 9.52308E-01
energy ratio w/o eroded energy. 9.52308E-01
global x velocity..... -1.26595E+04
global y velocity..... 4.14072E+01
global z velocity..... 4.47599E-01
cpu time per zone cycle..... 0 nanoseconds
average cpu time per zone cycle... 751 nanoseconds
average clock time per zone cycle.. 762 nanoseconds

7000 t 4.9819E-02 dt 9.94E-06 write runrsf file
7019 t 4.9998E-02 dt 9.95E-06 write d3plot file
7019 t 5.0008E-02 dt 9.95E-06 write d3dump01 file

***** termination time reached *****

7019 t 5.0008E-02 dt 9.95E-06 write d3plot file

Normal termination

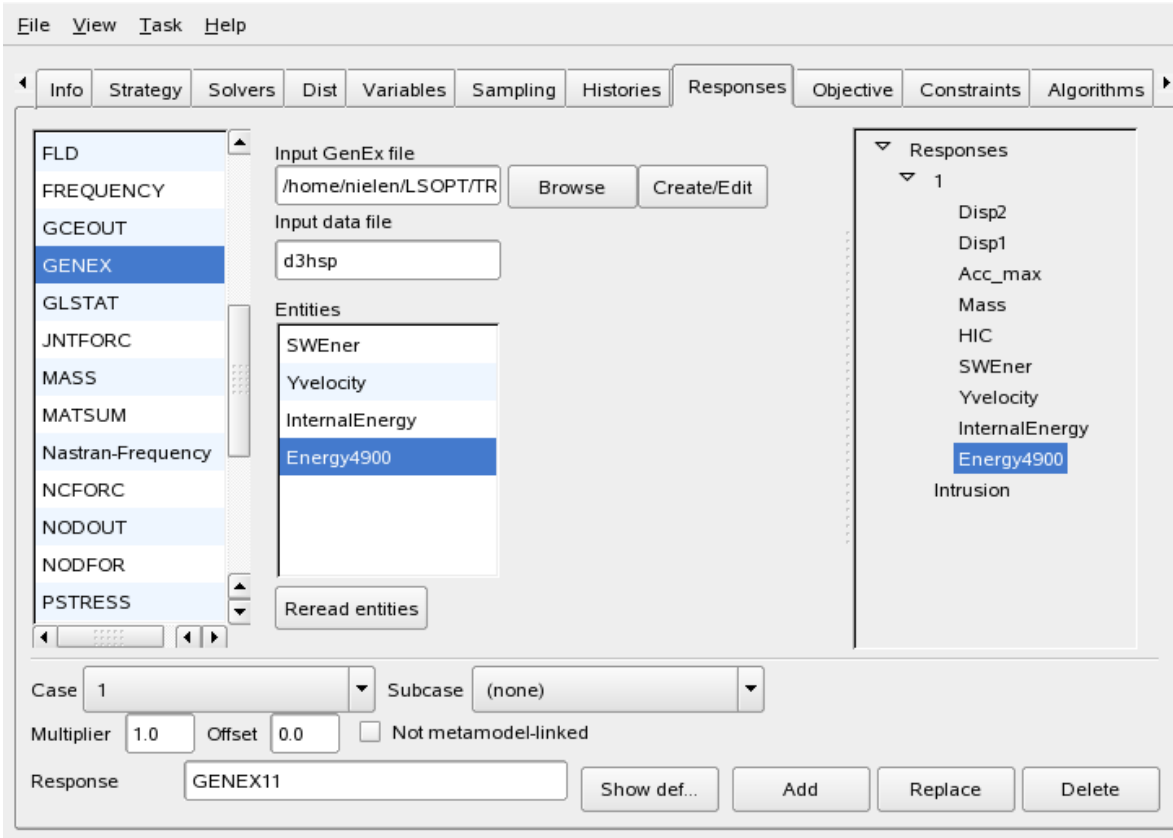
Storage allocation

Memory required to complete solution : 286361
Additional dynamically allocated memory: 5283
Total: 291644

```

Entity name: Energy4900  
Origin: LastCycle  
Number format:  
 Decimal separator(s): .  
 Exponent character(s): Ee  
Thousands separators:  
 ,  .  Space  
Relative location:  
0 lines,  
6 columns  
Column separators:  
 Tab  Space  Whitespace  
 ,  ;  |  
 Other:  
 Maximum length  
0 character(s)

14. This completes the GenEx setup. Save the file.
15. Now open the LS-OPT GUI on the **Responses** page and select the **GENEX** response type on the left. Open the Input GenEx file. A browse option is available. Importing the file will display the selected entities in the **Entities** box.
16. Select the input data file, namely d3hsp. This file must be available in the run directory during the LS-OPT run.
17. Select an entity, define a response name at the bottom of the page and **Add** the response. It will appear in the tree on the right associated with the selected case.
18. Repeat the procedure for the remaining three response entities. Note the last four entity definitions SWEner, Yvelocity, InternalEnergy and Energy4900 listed under Case 1 below.



LS-OPT can now be run and the response entities will be extracted for each simulation run.

### 14.11.5. An example using "Repeated anchor vector" to extract histories

In this example we will use GenEx to extract histories of the value for "kinetic energy" in the "glstat" file created by LS-DYNA. We first start by creating the anchor `dt_of_cycles`. This anchor will be the base for further anchors. With this anchor as parent we now create the `KE_anchor` to search for the string we are looking for, in this case "kinetic energy".

The screenshot shows the GenEx interface with a tree view on the left and a configuration panel on the right. The tree view shows a hierarchy: Start of File > dt\_of\_cycle > KE\_anchor > KE\_Entity. The main window displays two data blocks from a 'glstat' file. The first block is for 'element 51474' and the second for 'element 1948'. The configuration panel on the right is set up as follows:

- Entity name: KE\_Entity
- Origin: KE\_anchor
- Type of entity:  Scalar,  Column vector,  Repeated anchor vector
- Number format:  Decimal separator(s): .,  Exponent character(s): Ee
- Thousands separators:  ,  .  Space
- Relative location: 0 lines, 34 characters
- Column separators:  Tab,  Space,  Whitespace,  ,  ;  |,  Other:
- Maximum horizontal length: 11 character(s)
- Maximum number of components: 1
- Anchor to repeat: KE\_anchor

As seen in the screenshot above, this entity is of the Scalar type and needs to be changed to **Repeated anchor vector**. When creating a repeated anchor vector the default value for **Anchor to repeat** is the parent of the entity. Since "kinetic energy" appears twice between every `dt_of_cycle` the result is not what we want yet. In order to skip "eroded kinetic entity", we pick the grandparent `dt_of_cycle` anchor as the one to repeat.

The result of this setup will be that the extractor will find "`dt_of_cycle`", then search forward for "kinetic energy" and extract the first element of the vector. Then, it will find the next occurrence of "`dt_of_cycle`" and repeat, extracting the other elements of the vector.

The screenshot shows a software interface with a tree view on the left, a central data table, and a configuration panel on the right.

**Tree View:**

- Start of File
  - dt\_of\_cycle
    - KE\_anchor
      - KE\_Entity
- End of File

**Central Data Table:**

dt of cycle 1 is controlled by shell element 51474	
time.....	0.00000E+00
time step.....	5.00040E-07
kinetic energy.....	3.67699E+08
internal energy.....	7.96128E-06
stonewall energy.....	0.00000E+00 wall# 1
spring and damper energy.....	1.60000E-19
joint internal energy.....	0.00000E+00
hourglass energy.....	0.00000E+00
system damping energy.....	0.00000E+00
sliding interface energy.....	0.00000E+00
external work.....	0.00000E+00
eroded kinetic energy.....	0.00000E+00
eroded internal energy.....	0.00000E+00
total energy.....	3.67699E+08
total energy / initial energy..	1.00189E+00
energy ratio w/o eroded energy..	1.00189E+00
global x velocity.....	1.40547E-02
global y velocity.....	7.24379E-11
global z velocity.....	-2.15360E-11
time per zone cycle.(nanosec)..	649
number of shell elements that reached the minimum time step..	0
added mass.....	5.69522E-03
percentage increase.....	1.62208E-01
dt of cycle 400 is controlled by shell element 1948	
time.....	1.99516E-04
time step.....	5.00040E-07
kinetic energy.....	3.44904E+08
internal energy.....	2.05286E+07
stonewall energy.....	0.00000E+00 wall# 1
spring and damper energy.....	1.60000E-19
joint internal energy.....	3.35910E-02
hourglass energy.....	2.09104E+06
system damping energy.....	0.00000E+00
sliding interface energy.....	8.07489E+04
external work.....	2.78063E+00
eroded kinetic energy.....	0.00000E+00
eroded internal energy.....	0.00000E+00
total energy.....	3.67604E+08

**Configuration Panel:**

- Entity name: KE\_Entity
- Origin: KE\_anchor
- Type of entity:
  - Scalar
  - Column vector
  - Repeated anchor vector
- Number format:
  - Decimal separator(s): .
  - Exponent character(s): Ee
  - Thousands separators:  ,  .  Space
- Relative location:
  - 0 lines,
  - 34 characters
- Column separators:
  - Tab  Space  Whitespace
  - ,  ;  |
  - Other: [ ]
- Maximum horizontal length: 11 character(s)
- Maximum number of components: 1
- Anchor to repeat: KE\_anchor

After we have changed the **Anchor to repeat** to `dt_of_cycle`, we will have the correct result. The color of the other vector elements will be in light yellow with a dotted border.



The screenshot shows the GenEx software interface. On the left, a tree view shows the file structure: Start of File, dt\_of\_cycle, KE\_anchor, KE\_Entity, and End of File. The main window displays two tables of simulation results. The first table is for element 51474, and the second is for element 1948. The 'kinetic energy' values are highlighted in yellow. On the right, the Entity configuration panel is open, showing the following settings:

- Entity name: KE\_Entity
- Origin: KE\_anchor
- Type of entity: Repeated anchor vector (selected)
- Number format:
  - Decimal separator(s): .
  - Exponent character(s): Ee
  - Thousands separators: Space
- Relative location: 0 lines, 34 characters
- Column separators: Whitespace (checked)
- Maximum horizontal length: 11 character(s)
- Anchor to repeat: dt\_of\_cycle

We are now finished with the GenEx part and the file can be saved.

### 14.11.6. An example using "Column vector" to extract histories

Column vectors are useful for extracting vectors in tables. In this example we extract a position vector generated by a fictitious solver. Just as in the previous example we start with the creation of the entity we want to be the first. We then change the type to **Column vector**.

It's possible to create the vector by selecting a column in GenEx and right click to choose **New Entity**.



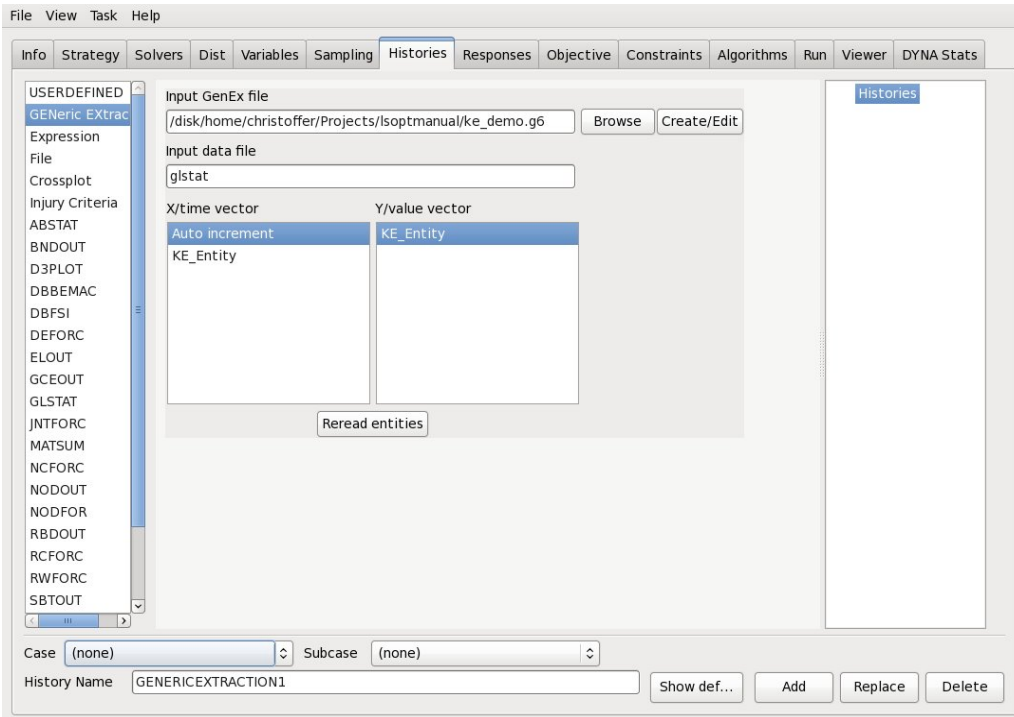
The screenshot displays the GenEx software interface. On the left, a tree view shows the file structure with 'Position' selected. The main window shows a table with the following data:

Time	Position	Speed
0	0	16
0.01	0.16	15.9018
0.02	0.319018	15.8036
0.03	0.477054	15.7054
0.04	0.634108	15.6072
0.05	0.79018	15.509
0.06	0.94527	15.4108
0.07	1.09936	15.3126
0.08	1.2525	15.2144
0.09	1.40465	15.1162
0.1	1.55581	15.018
0.11	1.70599	14.9198
0.12	1.85519	14.8216
0.13	2.0034	14.7234
0.14	2.15064	14.6252
0.15	2.29689	14.527
0.16	2.44216	14.4288
0.17	2.58645	14.3306
0.18	2.72975	14.2324
0.19	2.87208	14.1342
0.2	3.01342	14.036
0.21	3.15378	13.9378
0.22	3.29316	13.8396
0.23	3.43155	13.7414
0.24	3.56897	13.6432
0.25	3.7054	13.545
0.26	3.84085	13.4468
0.27	3.97532	13.3486
0.28	4.1088	13.2504
0.29	4.24131	13.1522
0.3	4.37283	13.054
0.31	4.50337	12.9558
0.32	4.63293	12.8576
0.33	4.7615	12.7594
0.34	4.8891	12.6612
0.35	5.01571	12.563
0.36	5.14134	12.4648
0.37	5.26599	12.3666
0.38	5.38965	12.2684
0.39	5.51234	12.1702
0.4	5.63404	12.072
0.41	5.75476	11.9738
0.42	5.8745	11.8756
0.43	5.99325	11.7774

On the right, the configuration panel for the 'Position' entity is shown. The 'Type of entity' is set to 'Column vector'. The 'Number format' options are checked for 'Decimal separator(s): .' and 'Exponent character(s): Ee'. The 'Relative location' is set to 2 lines and 11 characters. The 'Column separators' are set to 'Whitespace'. The 'Maximum horizontal length' is set to 8 characters. The 'Anchor to repeat' is set to 'Header'.

### 14.11.7. How to extract the histories from LS-OPT

Using GenEx for extracting histories is very similar to using it for responses. The main difference is that you have to select two entities in the **Histories** page, one for the x-axis and one for the y-axis. It's possible to use "Auto increment" for the x-axis, in which case the x-axis values will simply be 0,1,2,3...



When creating the entities in GenEx they need to be either **Column vector** or **Repeated anchor vector** to be used for history extraction.

## 14.12. User-defined interface for extracting results

The user may provide an own extraction routine to output a single floating-point number to standard output.

Examples of the output statement in such a program are:

- The C language:

```
printf ("%lf\n", output_value);
```

or

```
fprintf (stdout, "%lf\n", output_value);
```

- The FORTRAN language:

```
write (6,*) output_value
```

- The Perl script language:

```
print "$output_value\n";
```

- The string “N o r m a l” must be written to the standard error file identifier (`stderr` in C) to signify a normal termination. (See Section 22.1 for an example).
- The command to use a user-defined program to extract a response is:

**Command file syntax:**

---

```
response response_name { scale_factor offset } command_line
```

---

*Examples:*

1. The user has an own executable program "ExtractForce" which is kept in the directory \$HOME/own/bin. The executable extracts a value from a result output file.
2. The relevant response definition command must therefore be as follows:  
response 'Force' "\$HOME/own/bin/ExtractForce"
3. If *Perl* is to be used to execute the user script DynaFLD2, the command may be:  
response 'Acc' "\$LSOPT/perl \$LSOPT/DynaFLD2 0.5 0.25 1.833"

*Remark:*

1. An alias must not be used for an interface program.

### 14.13. Responses without metamodels

In some cases it may be beneficial to create intermediate responses without associated metamodels, but still part of a metamodel-based analysis. For example omitting intermediate neural networks will improve efficiency. The selection is simply made in a check box in the "Responses" panel (labeled "Not metamodel-linked"). Except for the metamodel linking, "Results" are identical to "Responses" and can be defined using a standard LS-DYNA interface, a mathematical expression or a command for a user-defined program.

**Command file syntax:**

---

```
result name string  
result name math_expression  
result name command_line
```

---

*Remark:*

1. "Results" cannot be included directly in composites, since a composite relies on interpolation from a metamodel.

### 14.14. Matrix operations

Matrix operations can be performed by initializing a matrix, performing multiple matrix operations, and extracting components of the matrix as response functions or results.

There are two functions available to initialize a matrix, namely `Matrix3x3Init` and `Rotate`. Both functions create  $3 \times 3$  matrices.

The component of a matrix is extracted using the format `A.ajj` (or the 0-based `A[i-1][j-1]`) e.g. `Strain.a23` (or `Strain[1][2]`) where  $i$  and  $j$  are limited to 1,2 or 3.

The matrix operation  $A - I$  (where  $I$  is the unit matrix) is coded as `A-1`.

### Command file syntax:

---

```
matrix name math_expression
```

---

### Examples:

In the following example the user constructs a matrix from scalar results, performs matrix operations and uses the final matrix components in an optimization run:

```
Constant 'X2' 0.0
Constant 'Y2' 0.0
Constant 'Z2' -1.0
Constant 'X3' 0.0
Constant 'Y3' 0.0
Constant 'Z3' 8.0
$
$           Extract results
$
result 'Fd11_2' "D3PlotResponse -setid 10 -tref 0.04 -coord 0 -1.858 1.858
-res_type misc -cmp history_var#11 -select TIME -end_time 0.04"
result 'Fd12_2' "D3PlotResponse -setid 10 -tref 0.04 -coord 0 -1.858 1.858
-res_type misc -cmp history_var#14 -select TIME -end_time 0.04"
result 'Fd13_2' "D3PlotResponse -setid 10 -tref 0.04 -coord 0 -1.858 1.858
-res_type misc -cmp history_var#17 -select TIME -end_time 0.04"
result 'Fd21_2' "D3PlotResponse -setid 10 -tref 0.04 -coord 0 -1.858 1.858
-res_type misc -cmp history_var#12 -select TIME -end_time 0.04"
result 'Fd22_2' "D3PlotResponse -setid 10 -tref 0.04 -coord 0 -1.858 1.858
-res_type misc -cmp history_var#15 -select TIME -end_time 0.04"
result 'Fd23_2' "D3PlotResponse -setid 10 -tref 0.04 -coord 0 -1.858 1.858
-res_type misc -cmp history_var#18 -select TIME -end_time 0.04"
result 'Fd31_2' "D3PlotResponse -setid 10 -tref 0.04 -coord 0 -1.858 1.858
-res_type misc -cmp history_var#13 -select TIME -end_time 0.04"
result 'Fd32_2' "D3PlotResponse -setid 10 -tref 0.04 -coord 0 -1.858 1.858
-res_type misc -cmp history_var#16 -select TIME -end_time 0.04"
result 'Fd33_2' "D3PlotResponse -setid 10 -tref 0.04 -coord 0 -1.858 1.858
-res_type misc -cmp history_var#19 -select TIME -end_time 0.04"
$
$           Matrix expressions
$
$           1. Initialization
$
```

```

matrix 'Fd_2'
{Matrix3x3Init(Fd11_2,Fd12_2,Fd13_2,Fd21_2,Fd22_2,Fd23_2,Fd31_2,Fd32_2,Fd33_2)}
matrix 'Fs_2'
{Matrix3x3Init(Fs11_2,Fs12_2,Fs13_2,Fs21_2,Fs22_2,Fs23_2,Fs31_2,Fs32_2,Fs33_2)}
matrix 'R_2' {Rotate(0, -1.858, 1.858, X2,Y2,Z2, X3,Y3,Z3)}
$
$      2. Matrix operations
$
$      Updated deformation gradient Fs
matrix 'FSD_2' {Fs_2 * inv (Fd_2)}
$      Updated Lagrange strain using Fs and Fd
matrix 'epsGlobal_2' {.5 * ( tr ( FSD_2 ) * FSD_2 - 1 )}
$      Tensor transformation to local coordinates
matrix 'epsCyl_2' {tr(R_2) * epsGlobal_2 * R_2}
$
$      3. Extract matrix components as response surfaces
$
response 'Ell_2' expression {epsCyl_2.a11}
response 'Ecc_2' expression {epsCyl_2.a33}
response 'Elc_2' expression {epsCyl_2.a13}
response 'Elr_2' expression {epsCyl_2.a12}
response 'Ecr_2' expression {epsCyl_2.a32}

```

### 14.14.1. Initializing a matrix

The command to initialize the matrix:

$$\begin{bmatrix} a_{11} & a_{12} & a_{13} \\ a_{21} & a_{22} & a_{23} \\ a_{31} & a_{32} & a_{33} \end{bmatrix}$$

is:

```
Matrix3x3Init(a11,a12,a13, a21,a22,a23, a31,a32,a33)
```

where  $a_{ij}$  is any previously defined variable (typically a response or result).

### 14.14.2. Creating a rotation matrix using 3 specified points

The command is:

```
Rotate(x1,y1,z1, x2,y2,z2, x3,y3,z3)
```

where the three triplets represent points 1, 2 and 3 in 3-dimensional space respectively.

- The vector  $v_{23}$  connecting points 2 and 3 forms the local  $X$  direction.
- $Z = v_{23} \times v_{21}$

○  $Y = Z \times X$

The vectors  $X$ ,  $Y$  and  $Z$  are normalized to  $x$ ,  $y$  and  $z$  which are used to form an orthogonal matrix:

$$T = \begin{bmatrix} x_1 & x_2 & x_3 \\ y_1 & y_2 & y_3 \\ z_1 & z_2 & z_3 \end{bmatrix}$$

where  $T^T T = I$ .

### 14.15. Injury criteria

All of the injury criteria were developed according to the specification in [33].

Injury criteria must be defined as responses.

The shaded rows in the tables below indicate obligatory arguments.

For the Head Injury Criteria (HIC) and Chest Severity Index see Section 14.21.

### 14.16. Head Injury Criteria

#### 14.16.1. HIC

See Section 14.21.

### 14.17. Neck Criteria

#### 14.17.1. MOC

MOC is the abbreviation for total Moment about Occipital Condyle. The criterion for the Total Moment calculates the total moment in relation to the moment measurement point.

The Total Moment MOC value for the Upper-Load-Cell is calculated as follows

$$MOC = M - (D \cdot F)$$

with	$MOC$	Total moment [Nm]
	$F$	Neck axial force resultant [N]
	$M$	Neck s-moment resultant [Nm]
	$D$	Distance between the force sensor axis and the Condyle axis, depends on the dummy type.

#### Expression syntax:

$MOC$  (*force*, *moment* [, *dummy\_type*, *length\_units*, *force\_units*, *distance*])

**Table 14-13: Options for MOC arguments**

Argument name	Description	Symbol	LS-OPT type	Default
<i>force</i>	Neck axial force resultant	<i>F</i>	History	
<i>moment</i>	Neck s-moment resultant	<i>M</i>	History	
<i>dummy_type</i>	Dummy type	-	See Table 14-14	HYBRID3M50
<i>length_units</i>	Length units	-	LENG_M, LENG_MM	LENG_MM
<i>force_units</i>	Force units	-	FORCE_N, FORCE_KN	FORCE_N
<i>distance</i>	Distance	<i>D</i>	Float	See Table 14-14

**Table 14-14: Input constants for various dummy types**

Dummy type	Description	D[m]
HYBRID3M95	Hybrid III, male 95%	0.01778
HYBRID3M50	Hybrid III, male 50%	0.01778
HYBRID3F05	Hybrid III, female 5%	0.01778
HYBRID310Y	Hybrid III, 10-year	0.01778
HYBRID306Y	Hybrid III, 6-year	0.01778
HYBRID303Y	Hybrid III, 3-year	0
CRABI1218M	Crabi 12, 18 month	0.00584
TNO P1	TNO P1,5	0.0247
CRABI6M	Crabi 6 month	0.0102
TNO P3	TNO P 3/4, P3	0
ES2	ES-2	0
TNO Q	TNO Q series	0
SID2S	SID-IIs	0.01778
BIORID	BioRID	0.01778
WORLD SID	WORLD SID	0.0195

*Example:*

```
response 'MOC_HYBRID3M50' expression {MOC ("axial(t)", "moment_S(t)",
HYBRID3M50, LENG_MM, FORCE_N)}
response 'MOC_HYBRID3M50_D' expression {MOC ("axial(t)", "moment_S(t)",
HYBRID3M50, LENG_MM, FORCE_N, 0.01778)}
response 'MOC_HYBRID3M95' expression {MOC ("axial(t)", "moment_S(t)",
HYBRID3M95, LENG_MM, FORCE_N)}
response 'MOC_HYBRID3F05' expression {MOC ("axial(t)", "moment_S(t)",
HYBRID3F05, LENG_MM, FORCE_N)}
```

### 14.17.2. NIC (rear impact)

NIC is the abbreviation for Neck Injury Criterion.  
 LS-OPT calculates the NIC value specified for rear impact.  
 The NIC value is calculated with the following formula:

$$NIC = a_{relative} \cdot 0.2 + v_{relative}^2$$

with  $a_{relative} = a_x^{TI} - a_x^{Head}$  relative x-acceleration

$$v_{relative} = \int a_{relative}$$

#### Expression syntax:

NIC (accel\_t, accel\_h [, time\_units, length\_units] )

Table 14-15: Options for NIC arguments

Argument name	Description	Symbol	LS-OPT type	Default
<i>accel_t</i>	x-acceleration of first thorax spine	$a_x^{TI}$	History	
<i>accel_h</i>	x-acceleration at the height of the c.o.g. of the head	$a_x^{Head}$	History	
<i>time_units</i>	Time units	-	TIME_S TIME_MS	TIME_S
<i>length_units</i>	Length units	-	LENG_M LENG_MM	LENG_MM

Example:

response 'NIC' expression {NIC ("x\_accel\_t(t)", "x\_accel\_h(t)", TIME\_S, LENG\_MM) }

### 14.17.3. Nij (Nce, Ncf, Nte, Ntf)

Nij is the abbreviation for Normalized Neck Injury Criterion and is the four neck criterion Nte (tension-expression), Ntf (tension-flexion), Nce (compression-extension) and Ncf (compression-flexion).  
 The Nij value is the maximal value of Nte, Ntf, Nce, Ncf.

The Nij value is calculated with the following formula

$$NIJ = \frac{F}{F_c} + \frac{MOC}{M_c}$$

with  $F$  Force at the point of transition from head to neck (t-shear resultant)

$F_c$  Critical force (depending on dummy type)

$MOC$  Total Moment (see  $MOC$ , section 14.17.1)

$M_c$  Critical moment (depending on dummy type)



**Expression syntax:**

$N_{ij}$  (force, moment, shear [, dummy\_type, length\_units, force\_units, c\_force\_tension, c\_force\_compression, c\_moment\_flexion, c\_moment\_extension, distance])

**Table 14-16: Options for  $N_{ij}$  arguments**

Argument name	Description	Symbol	LS-OPT type	Default
<i>force</i>	Neck axial force resultant	See MOC	History	
<i>moment</i>	Neck s-moment resultant	See MOC	History	
<i>shear</i>	Force at the point of transition from head to neck	$F$	History	
<i>dummy_type</i>	Dummy type	-	See Table 14-17	HYBRID3M50
<i>length_units</i>	Length units	-	LENG_M, LENG_MM	LENG_MM
<i>force_units</i>	Force units	-	FORCE_N, FORCE_KN	FORCE_N
<i>c_force_tension</i>	Critical force tension	$F_c$	Float	See Table 14-17
<i>c_force_compression</i>	Critical force compression	$F_c$	Float	See Table 14-17
<i>c_moment_flexion</i>	Critical moment flexion	$M_c$	Float	See Table 14-17
<i>c_moment_extension</i>	Critical moment extension	$M_c$	Float	See Table 14-17
<i>distance</i>	Distance	$D$ (See MOC)	Float	See Table 14-17

**Table 14-17: Input constants for various dummy types**

Dummy type	Description	Test	$F_C$ [N] Tension	$F_C$ [N] Compression	$M_C$ [Nm] Flexion	$M_C$ [Nm] Extension
HYBRID3M50	Hybrid III;	In	6806	-6160	310	-135

	male 50%	position				
HYBRID3F05	Hybrid III; female 5%	In position	4287	-3880	155	-67
HYBRID3F05	Hybrid III; female 5%	Out of position	3880	-3880	155	-61
HYBRID310Y	Hybrid III; 6-year	Out of position	2800	-2800	93	-37
HYBRID306Y	Hybrid III; 3-year	Out of position	2120	-2120	68	-27
HYBRID303Y	Hybrid III; 12 month	Out of position	1460	-1460	43	-17

*Example:*

```
response 'Nij_HYBRID3M50' expression {Nij
("axial(t)", "moment_S(t)", "shear_T(t)", HYBRID3M50, LENG_MM, FORCE_N) }
response 'Nij_HYBRID3M50_const' expression {Nij
("axial(t)", "moment_S(t)", "shear_T(t)", , LENG_MM, FORCE_N, 6806, 6160, 310, 135, 0.01778) }
response 'Nij_HYBRID3F05' expression {Nij
("axial(t)", "moment_S(t)", "shear_T(t)", HYBRID3F05, LENG_MM, FORCE_N) }
response 'Nij_HYBRID3F05_const' expression {Nij
("axial(t)", "moment_S(t)", "shear_T(t)", , LENG_MM, FORCE_N, 4287, 3880, 155, 67, 0.01778) }
response 'Nij_HYBRID3F05_oop' expression {Nij
("axial(t)", "moment_S(t)", "shear_T(t)", HYBRID3F05_OOP, LENG_MM, FORCE_N) }
response 'Nij_HYBRID3_6Y' expression {Nij
("axial(t)", "moment_S(t)", "shear_T(t)", HYBRID306Y, LENG_MM, FORCE_N) }
response 'Nij_HYBRID3_3Y' expression {Nij
("axial(t)", "moment_S(t)", "shear_T(t)", HYBRID303Y, LENG_MM, FORCE_N) }
```

**14.17.4. Nkm (Nfa, Nea, Nfp, Nep)**

Nkm corresponds to the four neck criteria Nfa (flexion-anterior), Nea (extension-anterior), Nfp (flexion-posterior) and Nep (extension-posterior).

The Nkm value is calculated with the following formula, [34]:

$$Nkm(t) = \frac{F(t)}{F_{int}} + \frac{MOC(t)}{M_{int}}$$

- with  $F$  Force at the point of transition from head to neck (axial force resultant)
- $F_{int}$  Critical force
- $MOC$  Total Moment (see MOC, section 14.17.1)
- $M_{int}$  Critical moment

**Expression syntax:**

Nkm (force, moment [, dummy\_type, length\_units, force\_units, criteria\_type, distance, critical\_force, critical\_moment])

**Table 14-18: Options for Nkm arguments**

Argument name	Description	Symbol	LS-OPT type	Default
<i>force</i>	Neck axial force resultant	$F$	History	
<i>moment</i>	Neck s-moment resultant	See MOC	History	
<i>dummy_type</i>	Dummy type	-	See Table 14-13 (MOC)	HYBRID3M50
<i>length_units</i>	Length units	-	LENG_M, LENG_MM	LENG_MM
<i>force_units</i>	Force units	-	FORCE_N, FORCE_KN	FORCE_N
<i>criteria_type</i>	Nfa, Nea, Nfp, Nep	-	FLEXION_ANTERIOR EXTENSION_ANTERIOR FLEXION_POSTERIOR EXTENSION_POSTERIOR	FLEXION_ANTERIOR
<i>distance</i>	Distance	$D$ (See MOC)	Float	See Table 14-13 (MOC)
<i>critical_force</i>	Critical force	$F_{int}$	Float	See Table 14-13
<i>critical_moment</i>	Critical moment	$M_{int}$	Float	See Table 14-13

**Table 14-19: Input constants**

Criteria	Description	Value
* ANTERIOR	Positive Shear $F_{int}$	845 N
* POSTERIOR	Negative Shear $F_{int}$	-845 N
FLEXION *	Flexion $M_{int}$	88.1 Nm
EXTENSION *	Extension $M_{int}$	-47.5 Nm

*Example:*

```

response 'Nea_HYBRID3M50' expression {Nkm
("axial(t)", "moment_S(t)", HYBRID3M50, LENG_MM, FORCE_N, EXTENSION_ANTERIOR) }
response 'Nep_User' expression {Max ("Nep_curve_User(t)", , ) }
response 'Nep_HYBRID3M50' expression {Nkm
("axial(t)", "moment_S(t)", HYBRID3M50, LENG_MM, FORCE_N, EXTENSION_POSTERIOR) }
response 'Nfa_User' expression {Max ("Nfa_curve_User(t)", , ) }
response 'Nfa_HYBRID3M50' expression {Nkm
("axial(t)", "moment_S(t)", HYBRID3M50, LENG_MM, FORCE_N, FLEXION_ANTERIOR) }
response 'Nfp_User' expression {Max ("Nfp_curve_User(t)", , ) }
response 'Nfp_HYBRID3M50' expression {Nkm
("axial(t)", "moment_S(t)", HYBRID3M50, LENG_MM, FORCE_N, FLEXION_POSTERIOR) }
response 'Nfp_HYBRID3M50_const_D' expression {Nkm
("axial(t)", "moment_S(t)", HYBRID3M50, LENG_MM, FORCE_N, FLEXION_POSTERIOR, 0.01778) }
response 'Nfp_HYBRID3M50_const_F_M' expression {Nkm
("axial(t)", "moment_S(t)", HYBRID3M50, LENG_MM, FORCE_N, FLEXION_POSTERIOR, , -845, 88.1) }

```

### 14.17.5. LNL

LNL is the abbreviation for the Lower Neck Load Index.  
 The LNL value is calculated with the following formula:

$$LNL = \frac{\sqrt{M_y^2 + M_x^2}}{C_{moment}} + \frac{\sqrt{F_y^2 + F_x^2}}{C_{shear}} + \left| \frac{F_z + off}{C_{tension}} \right|$$

- with  $M_y$  s-Moment resultant
- $M_x$  Torsional resultant
- $C_{moment}$  Critical moment
- $F_x$  s-Shear resultant
- $F_y$  Axial force resultant
- $C_{shear}$  Critical force
- $F_z$  t-Shear resultant
- $C_{tension}$  Critical force
- $off$  offset to include pre-load, depends on dummy position

**Expression syntax:**

LNL (axial\_force, s\_shear, t\_shear, s\_moment, torsion [, length\_units, force\_units, critical\_moment, critical\_shear, critical\_tension])

**Table 14-20: Options for LNL arguments**

Argument name	Description	Symbol	LS-OPT type	Default
<i>axial_force</i>	Axial force resultant	$F_y$	History	
<i>s_shear</i>	s-Shear resultant	$F_x$	History	
<i>t_shear</i>	t-Shear resultant	$F_z$	History	
<i>s_moment</i>	s-Moment resultant	$M_y$	History	
<i>torsion</i>	Torsional resultant	$M_x$	History	
<i>length_units</i>	Length units	-	LENG_M, LENG_MM	LENG_MM
<i>force_units</i>	Force units	-	FORCE_N, FORCE_KN	FORCE_N
<i>critical_moment</i>	Critical moment	$C_{moment}$	Float	<i>See</i>  Table 14-21

<i>critical_shear</i>	Critical force	$C_{shear}$	Float	<b>See</b> Table 14-21
<i>critical_tension</i>	Critical force	$C_{tension}$	Float	<b>See</b> Table 14-21

**Table 14-21: Input constants**

<b>Force/Moment</b>	<b>Description</b>	<b>Value</b>
$C_{moment}$	Critical moment	15 [Nm]
$C_{shear}$	Critical force	250 [N]
$C_{tension}$	Critical force	900 [N]

**Example:**

```
response 'LNL_BIORID2' expression {LNL
("axial(t)", "s_Shear(t)", "t_Shear_180(t)", "moment_S(t)", "Torsion(t)", BIORID2, LENG_MM, FORCE_N) }
response 'LNL_const_BIORID2' expression {LNL
("axial(t)", "s_Shear(t)", "t_Shear_180(t)", "moment_S(t)", "Torsion(t)",
, LENG_MM, FORCE_N, 15, 250, 900) }
```

## 14.18. Chest Criteria

### 14.18.1. Chest compression

Maximum relative rotation multiplied by a constant:

$$C_1 \max_t [\Theta(t)]$$

**Expression syntax:**

ChestCompression ( relative\_rotation, dummy\_type, user\_constant )

**Table 14-22: Options for Chest Compression arguments**

<b>Argument name</b>	<b>Description</b>	<b>Symbol</b>	<b>LS-OPT type</b>	<b>Default</b>
<i>relative_rotation</i>	relative rotation history	$\Theta(t)$	History	

<i>dummy_type</i>	dummy type	-	HYBRID3M95 HYBRID3M50 HYBRID3F05	HYBRID3M50
<i>constant</i>	Multiplier	$C_I$	Float	See Table 14-23

**Table 14-23: Input constants for various dummy types**

Dummy type	Description	Scaling factor $C_I$
HYBRID3M95	Hybrid III; male 95%	130.67
HYBRID3M50	Hybrid III; male 50%	-139.0
HYBRID3F05	Hybrid III; female 5%	-87.58

Remarks:

1. The history *relative\_rotation*  $\Theta(t)$  must be in double quotes.
2. The user is responsible for any required filters of the input history.

Examples:

```
response 'CC_HYBRID3M50_alt' expression { -139 * Max( "a(t)" ) }
response 'CC_HYBRID3M50_139' expression { ChestCompression ( "a(t)", HYBRID3M50, -139 ) }
response 'CC_HYBRID3M50' expression { ChestCompression ( "a(t)", HYBRID3M50 ) }
response 'CC_HYBRID3M95' expression { ChestCompression ( "a(t)", HYBRID3M95 ) }
```

### 14.18.2. Viscous criterion (VC)

VC is an injury criterion for the chest area. The VC value [m/s] is the maximum crush of the momentary product of the thorax deformation speed and the thorax deformation. Both quantities are determined by measuring the rib deflection (side impact) or the chest deflection (frontal impact). The formula is:

$$- \min \frac{C_1}{C_2} C_3 Y(t) C_3 \frac{dY(t)}{dt}$$

#### Expression syntax:

ViscousCriterion ( history\_name, [dummy\_type, time\_units, length\_units, scaling\_factor, deformation\_constant, user\_constant] )

**Table 14-24: Options for Viscous Criterion arguments**

Argument name	Description	Symbol	LS-OPT type	Default
<i>history_name</i>	Thoracic deformation (m)	$Y(t)$	History	
<i>dummy_type</i>	Dummy type	–	See Table 2	HYBRID3M50
<i>time_units</i>	Time units	–	TIME_S TIME_MS	TIME_S (seconds)
<i>length_units</i>	Length units	–	LENG_M LENG_MM	LENG_MM (mm)
<i>scaling_factor</i>	Scaling factor (multiplier)	$C_1$	Float	See Table 14-25
<i>deformation_constant</i>	Constant: Depth or width of half the rib cage (m)	$C_2$	Float	See Table 14-25
<i>user_constant</i>	Multiplier of thoracic deformation	$C_3$	Float	1.0

Table 14-25: Input constants for various dummy types

Dummy type	Description	Scaling factor	Deformation constant (m)
HYBRID3M95	Hybrid III; male 95%	1.3	0.254
HYBRID3M50	Hybrid III; male 50%	1.3	0.229
HYBRID3F05	Hybrid III; female 5%	1.3	0.187
BIORID2	BioSID	1.0	0.175
EUROSID1	EuroSID-1	1.0	0.140
EUROSID2	EuroSID-2	1.0	0.140
SID2S	SID-IIs	1.0	0.138

Remarks:

1. The history name should be provided in double quotes.
2. The derivative is computed using the 4<sup>th</sup> order (template size = 5) finite difference approximation:

$$\frac{df}{dt} = \frac{f_{i-2} - 8f_{i-1} + 8f_{i+1} - f_{i+2}}{12h} + O(h^4)$$

where  $h$  is the time interval between the single measurements.

3. The user is responsible for any required filters of the input history.

Examples:

```
response 'VC_HYB3M50' expression {ViscousCriterion ( "a(t)" )}
response 'VC_HYB3M50' expression {ViscousCriterion ( "a(t)", HYBRID3M50,
TIME_S, LENG_MM )}
response 'VC_HYB3M50_C2_229' expression {ViscousCriterion ( "a(t)",, TIME_S,
LENG_MM, 1.3, .229 )}
```

```

response 'VC_HYB3M50_C3_10' expression {ViscousCriterion ( "a(t)", HYBRID3M50,
TIME_S, LENG_MM, , , 10 )}
response 'VC_HYB3M95' expression {ViscousCriterion ( "a(t)", HYBRID3M95,
TIME_S, LENG_MM )}
response 'VC_HYB3M50_C2_254' expression {ViscousCriterion ( "a(t)", , TIME_S,
LENG_MM, 1.3 , .254 )}
response 'VC_HYB3F05' expression {ViscousCriterion ( "a(t)", HYBRID3F05,
TIME_S, LENG_MM )}
response 'VC_HYB3M50_C2_187' expression {ViscousCriterion ( "a(t)", , TIME_S,
LENG_MM, 1.3 , .187 )}
response 'VC_BIORID2' expression {ViscousCriterion ( "a(t)", BIORID2, TIME_S,
LENG_MM )}

```

### 14.18.3. Thoracic Trauma Index (TTI)

TTI is the abbreviation for Thoracic Trauma Index (Thorax Trauma Index).

The TTI value is calculated using the following formula:

$$TTI = \frac{A(max.rib) + A(lwr.spine)}{2}$$

$$A(max.rib) = \max\{A(upr.rib), A(lwr.rib)\}$$

- with  $A(upr.rib)$  Maximum y-acceleration of the upper rib
- $A(lwr.rib)$  Maximum y-acceleration of the lower rib
- $A(lwr.spine)$  Maximum y-acceleration of the lower spine

The result is divided by the gravitational acceleration  $g$ .

#### Expression syntax:

TTI (accel\_upper\_rib, accel\_lower\_rib, accel\_lower\_spine, time\_units, length\_units, gravity)

Table 14-26: Options for TTI arguments

Argument name	Description	Symbol	LS-OPT type	Default
<i>accel_upper_rib</i>	y-acceleration of the upper rib	$A(upr.rib)$	History	
<i>accel_lower_rib</i>	y-acceleration of the lower rib	$A(lwr.rib)$	History	
<i>accel_lower_spine</i>	y-acceleration of the lower spine	$A(lwr.spine)$	History	
<i>time_units</i>	Time units	-	TIME_S TIME_MS	TIME_S
<i>length_units</i>	Length units	-	LENG_M, LENG_MM	LENG_MM
<i>gravity</i>	Gravitational acceleration	$g$	Float	Depends on <i>time_units</i> and <i>length_units</i> .



				9810 mm/s <sup>2</sup> if units undefined
--	--	--	--	---

*Example:*

```
response 'TTI_' expression {TTI
("accel_upper_rib(t)", "accel_lower_rib(t)", "accel_lower_spine(t)", TIME_S, LENG_MM) }
response 'TTI_gravity' expression {TTI
("accel_upper_rib(t)", "accel_lower_rib(t)", "accel_lower_spine(t)", , , 9810) }
```

## 14.19. Criteria for the Lower Extremities

### 14.19.1. Tibia Index (TI)

TI is the abbreviation for the Tibia Index.

The calculation of the TI value is based on the equation

$$TI = \left| \frac{M}{M_C} \right| + \left| \frac{F}{F_C} \right|$$

$$M = \sqrt{(M_x)^2 + (M_y)^2}$$

with  $M_{x/y}$  Bending moments [Nm] (torsional resultant, s-moment resultant)

$M_C$  Critical bending moment

$F$  Axial compression [kN] (t-shear resultant)

$F_C$  Critical compression force

#### Expression syntax:

```
TibiaIndex (torsion, s_moment, t_shear, dummy_type, length_units,
force_units, critical_moment, critical_force)
```

**Table 14-27: Options for TI arguments**

Argument name	Description	Symbol	LS-OPT type	Default
<i>torsion</i>	Bending moment, torsional resultant	$M_x$	History	
<i>s_moment</i>	Bending moment, s-moment resultant	$M_y$	History	
<i>t_shear</i>	Axial compression, t-shear resultant	$F$	History	
<i>dummy_type</i>	Dummy type	-	See Table 14-28	HYBRID3M50
<i>length_units</i>	Length units	-	LENG_M, LENG_MM	LENG_MM

<i>force_units</i>	Force units	-	FORCE_N, FORCE_KN	FORCE_N
<i>critical_moment</i>	Critical bending moment	$M_C$	Float	See Table 14-28
<i>critical_force</i>	Critical compression force	$F_C$	Float	See Table 14-28

**Table 14-28: Input constants for various dummy types**

Dummy type	Description	Critical bending moment [Nm]	Critical compression force [kN]
HYBRID3M95	Hybrid III, male 95%	307.0	44.2
HYBRID3M50	Hybrid III, male 50%	225.0	35.9
HYBRID3F05	Hybrid III, female 5%	115.0	22.9

*Example:*

```
response 'TI_HYBRID3M50' expression {TibiaIndex
("Torsion(t)", "moment_S(t)", "shear_T(t)", HYBRID3M50, LENG_MM, FORCE_N) }
response 'TI_HYBRID3M95' expression {TibiaIndex
("Torsion(t)", "moment_S(t)", "shear_T(t)", HYBRID3M95, LENG_MM, FORCE_N) }
response 'TI_HYBRID3F05' expression {TibiaIndex
("Torsion(t)", "moment_S(t)", "shear_T(t)", HYBRID3F05, LENG_MM, FORCE_N) }
response 'TI_HYBRID3F05_const' expression {TibiaIndex
("Torsion(t)", "moment_S(t)", "shear_T(t)", HYBRID3F05, LENG_MM, FORCE_N, 115, 22.9) }
```

## 14.20. Additional Criteria

### 14.20.1. A3ms

The smallest resultant acceleration level maintained for 3 ms.  $r_{\Delta t}$  is computed as the level of  $r = \sqrt{\ddot{x}^2 + \ddot{y}^2 + \ddot{z}^2}$  exceeded for the specified time interval  $\Delta t$  (default = 3ms). The resulting acceleration level is divided by the gravitational acceleration, g.

#### Expression syntax:

```
A3ms ( accel_x, [ accel_y, accel_z, time_units, length_units,
time_interval, gravity ] )
```

**Table 14-29: Options for a3ms arguments**

Argument name	Description	Symbol	LS-OPT type	Default
<i>accel_x</i>	x-acceleration history	$\ddot{x}$	History	
<i>accel_y</i>	y-acceleration history	$\ddot{y}$	History	no history

<i>accel_z</i>	z-acceleration history	$\ddot{z}$	History	no history
<i>time_units</i>	Time units	-	TIME_S TIME_MS	TIME_S (seconds)
<i>length_units</i>	Length units	-	LENG_M LENG_MM	LENG_MM (mm)
<i>time_interval</i>	Time interval for which the acceleration is exceeded	$\Delta t$	Float	0.003 s
<i>gravity</i>	Gravitational acceleration	$g$	Float	Depends on <i>time_units</i> and <i>length_units</i> . 9810 mm/s <sup>2</sup> if units undefined

*Remarks:*

1. *Accel\_y* ( $\ddot{y}$ ) and *accel\_z* ( $\ddot{z}$ ) are optional.
2. The user is responsible for any required filters of the input history.

*Examples:*

```
response 'AMS_3ms_9810' expression {A3ms ( "ax(t)", "ay(t)", "az(t)", 0.003, 9810. )}
response 'AMS_default' expression {A3ms ( "ax(t)", "ay(t)", "az(t)" )}
response 'AMS_default_reorder' expression {A3ms("ay(t)","az(t)", "ax(t)")}
response 'AMS_3ms' expression {A3ms ( "ax(t)", "ay(t)", "az(t)", 0.003 )}
response 'AMS_x_y' expression {A3ms ( "ax(t)", "ay(t)" )}
response 'AMS_x' expression {A3ms ( "ax(t)" )}
response 'AMS_x_10ms' expression {A3ms ( "ax(t)", _ , _ , .01 )}
response 'AMS_file' expression {A3ms ( "hfile(t)", , , 0.004, 9810. )}
```

### 14.21. Binout injury criteria

Injury criteria such as HIC can be specified as the result component. The acceleration components will be extracted, the magnitude computed, and the injury criteria computed from the acceleration magnitude history.

**Command file syntax:**

---

```
BinoutResponse {history_options} -cmp cmp {-gravity gravity -units units}
```

---

Item	Description	Default
<i>history_options</i>	All available history options including filtering and slicing.	-
<i>cmp</i>	HIC15, HIC36, CSI, CLIP3M, CLIP3M_3NODE	-

<i>lengthunits</i>	METER=meter MM=millimeter	METER
<i>units</i>	S=seconds MS=milliseconds	S

*Note:*

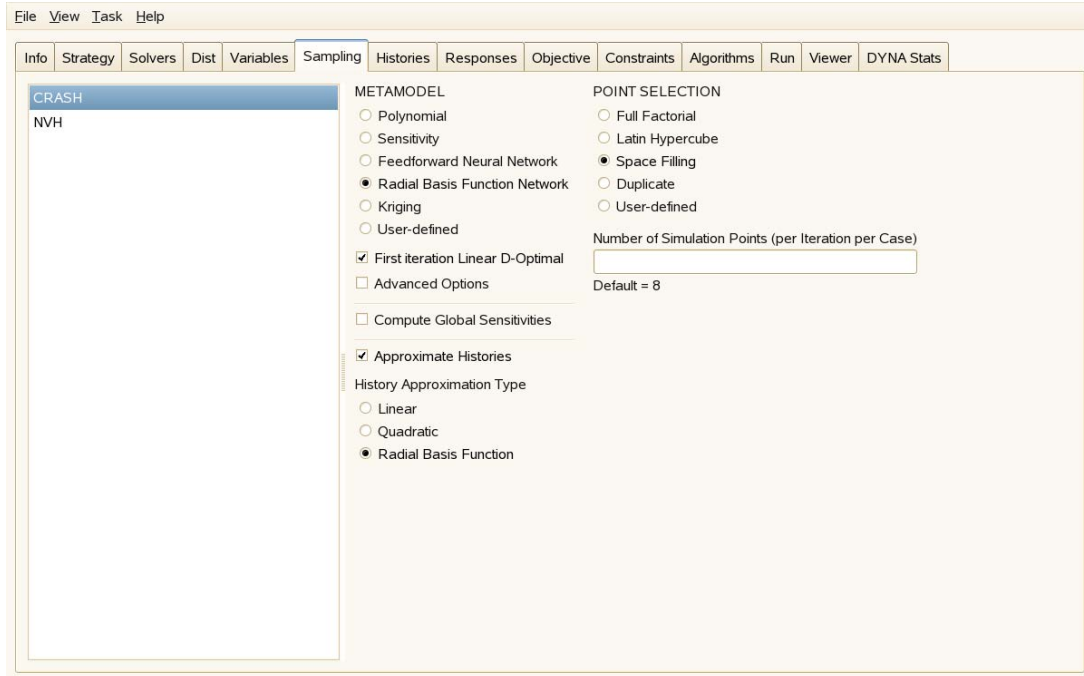
1. The length and time units are used to compute the gravity value based on  $9.81 \text{ m/s}^2$

**Example:**

```
response 'HIC_ms' 1 0 "BinoutResponse -res_type Nodout -cmp HIC15 -lengthunits
MM -units MS -name RAIL15"
```

## 14.22. Virtual history

Each history curve can be pointwise (at each sampled time-step) approximated using metamodels. These approximations of the entire history curves in time-domain are called virtual histories. These history approximations are used to study the influence of changes in the variables as well as for parameter identification problems. The approximation of histories is enabled by setting the “Approximate Histories” flag on the sampling page as shown in Figure 14-5. The user can approximate the data using either linear or quadratic polynomials or by radial basis functions. The approximations are carried out on the sampling points used for response approximations. While the approximation models for the histories and responses can be different, the number and location of sampling points remain the same such that all options for history approximation may not be suitable depending on the number of available data points, for example, if the response sampling is linear polynomial the number of points sampled would not be sufficient to approximate the histories using a quadratic polynomial and that option should be avoided. It is also important to note that approximation of histories may take significantly long as approximations at thousands of time-steps are carried out. For more information on the metamodeling, we refer the user to Chapter 13.



*Figure 14-5 Setting flag to create virtual histories.*

#### Command file syntax:

---

```
solver approximate history {linear|quadratic|RBF}
```

---

#### Example:

```
solver approximate history RBF
```

#### Remarks:

1. It is assumed that the each history curve has the same number of time-steps for all points.
2. For sequential strategies, all points sampled so far would be used for creating RBF approximations, whereas only the points sampled in the current iteration are used for polynomial approximations.

## 14.23. REFERENCES

- [33] Data Processing Vehicle Safety Work Group – Crash Analysis Criteria Description. Version 2.1.1 Arbeitskreis Messdatenverarbeitung Fahrzeugsicherheit, May 2008.
- [34] K.-U. Schmitt, M. Muser, How to calculate the  $N_{km}$ , Working Group on Accident Mechanics, Zürich, 2003

# 15. Composite Functions

Composite functions can be used to combine response surfaces and variables as well as other composites. The objectives and constraints can then be constructed using the composite functions.

## 15.1. Introduction

### 15.1.1. Composite vs. response expressions

There is an important distinction between response expressions and composites. This distinction can have a major impact on the accuracy of the result. Response expressions are converted to response surfaces after applying the expression to the results of each sampling point in the design space. Composites, on the other hand, are computed by combining response surface results. Therefore the response expression will always be of the same order as the chosen response surface order while the composite can assume any complexity depending on the formula specified for the composite (which may be arbitrary).

Example: If a response function is defined as  $f(x, y) = xy$  and linear response surfaces are used, the response expression will be a simple linear approximation  $ax + by$  whereas a composite expression specified as  $xy$  will be exact.

There are three types of composites:

## 15.2. Expression composite

### 15.2.1. General expressions

A general expression can be specified for a composite. The composite can therefore consist of constants, variables, dependent variables, responses and other composites (see **Appendix D**).

### 15.2.2. Special expressions

There are two special functions for composites namely `MeanSqErr` for ordinate-based curve matching and `CurveMapSegment3` for curve mapping (see Section 15.6).

## 15.3. Standard composite

### 15.3.1. Targeted composite (square root of MSE)

This is a special composite in which a target is specified for each response or variable. The composite is formulated as the ‘distance’ to the target using a Euclidean norm formulation. The components can be weighted and normalized.

$$F = \sqrt{\sum_{j=1}^m W_j \left[ \frac{f_j(\mathbf{x}) - F_j}{\sigma_j} \right]^2 + \sum_{i=1}^n \omega_i \left[ \frac{x_i - X_i}{\chi_i} \right]^2}, \quad (15-1)$$

where  $\sigma$  and  $\chi$  are scale factors and  $W$  and  $\omega$  are weight factors. These are typically used to formulate a multi-objective optimization problem in which  $F$  is the distance to the target values of design and response variables.

A suitable application is parameter identification. In this application, the target values  $F_j$  are the experimental results that have to be reproduced by a numerical model as accurately as possible. The scale factors  $\sigma_j$  and  $\chi_i$  are used to normalize the responses. The second component, which uses the variables can be used to regularize the parameter identification problem. Only independent variables can be included. See Figure 15-1 for an example of a targeted composite response definition.

In the GUI this type is now selected as the “Root MSE” type.

### 15.3.2. Mean squared error composite

This special composite is the same as the targeted composite, except that the square root operation is omitted. This allows for composites to be added to make a larger composite (similar to the vector ordinate-based `MeanSqErr` composite in Section 15.6.1).

### 15.3.3. Weighted composite

Weighted response functions and independent variables are summed in this standard composite. Each function component or variable is scaled and weighted.

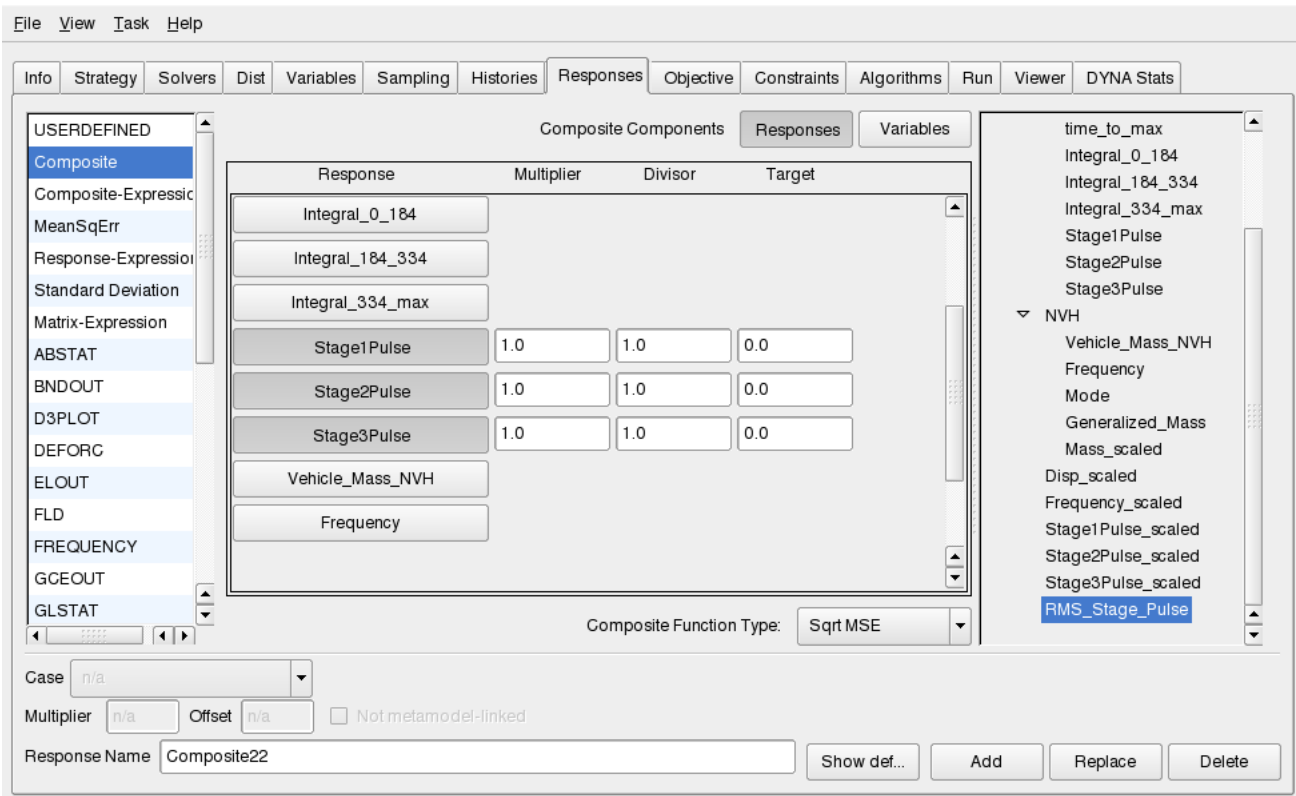
$$F = \sqrt{\sum_{j=1}^m W_j \frac{f_j(\mathbf{x})}{\sigma_j} + \sum_{i=1}^n \omega_i \frac{x_i}{\chi_i}}. \quad (15-2)$$

These are typically used to construct objectives or constraints in which the responses and variables appear in linear combination.

The expression composite is a simple alternative to the weighted composite.

*Remarks:*

1. An expression composite can be a function of any other composite.
2. An objective definition involving more than one response or variable requires the use of a composite function.
3. In addition to specifying more than one function per objective, multiple objectives can be defined (see Section 16.2).



*Figure 15-1: Definition of targeted (Root MSE) composite response in LS-OPTui*

## 15.4. Defining the composite function

This command identifies the composite function. The type of composite is specified as *weighted*, *targeted* or *expression*. The *expression* composite type does not have to be declared and can simply be stated as an expression.

### Command file syntax:

---

```
composite composite_name type [standardMSE|targeted|weighted]
```

---



*Example:*

```
composite 'Damage' type targeted
composite 'Acceleration' type weighted
```

The expression composite is defined as follows:

**Command file syntax:**

---

```
composite composite_name math_expression
```

---

The math\_expression is a mathematical expression given in curly brackets (see **Appendix D**).

The number of composite functions to be employed must be specified in the problem description.

## 15.5. Assigning design variable or response components to the composite

**Command file syntax:**

---

```
composite name response response_name value <1> { scale
scale_factor <1> }
composite name variable variable_name value { scale
scale_factor <1> }
```

---

The value is the target value for type: targeted and the weight value for the type: weighted. The scale\_factor is a divisor.

*Example:*

```
composite 'damage' type targeted
composite 'damage' response 'intrusion_3' 20. scale 30.
composite 'damage' response 'intrusion_4' -35. scale 25.
```

for the composite function  $F_{damage} = \sqrt{\left[\frac{f_3 - 20}{30}\right]^2 + \left[\frac{f_4 - 35}{25}\right]^2}$ .

The equivalent code using the expression composite is:

```
composite 'damage' {sqrt(((intrusion_3 - 20)/30)**2 +
((intrusion_4 + 35)/25)**2)}
```

*Example:*

```
$----- x10 > x9 -----
```

```

composite 'C9' type weighted
composite 'C9' variable 'x_9' -1.
composite 'C9' variable 'x_10' 1.
constraint 'C9'
Lower bound constraint 'C9' 0.

```

for the composite function which defines the inequality  $x_{10} > x_9$ .

The equivalent code using the expression composite is:

```

$----- x10 > x9 -----
composite 'C9' {x_10 - x_9}
constraint 'C9'
Lower bound constraint 'C9' 0.

```

Needless to say, this is the preferable way to describe this composite.

If weights are required for the targeted function, an additional command may be given.

### Command file syntax:

---

```
weight weight value <1>
```

---

#### Example:

```

composite 'damage' type targeted
composite 'damage' response 'intrusion_3' 20.
weight 1.5
composite 'damage' response 'intrusion_4' -35.

```

is used to specify  $F_{damage} = \sqrt{1.5(f_3 - 20)^2 + (f_4 - 35)^2}$ .

The weight applies to the last specified composite and response.

## 15.6. Curve Matching

### 15.6.1. Ordinate-based Curve Matching

A special function MeanSqErr is provided to compute the Mean Squared Error for the discrepancy between two curves:

$$\varepsilon = \frac{1}{P} \sum_{p=1}^P W_p \left[ \frac{f_p(\mathbf{x}) - G_p}{s_p} \right]^2 = \frac{1}{P} \sum_{p=1}^P W_p \left[ \frac{e_p(\mathbf{x})}{s_p} \right]^2, \quad (15-3)$$

It is constructed so that  $G_p$ ,  $p=1, \dots, P$  are the values on the target curve  $G$  and  $f_p(\mathbf{x})$  the corresponding components of the computed curve  $f$ .  $f_p(\mathbf{x})$  are represented internally by response surface values.  $\mathbf{x}$  is the

design vector. By using the default values, the user should obtain a dimensionless error  $\varepsilon$  of the order of unity. See Section 5.3.1 for more detail.

### Expression syntax:

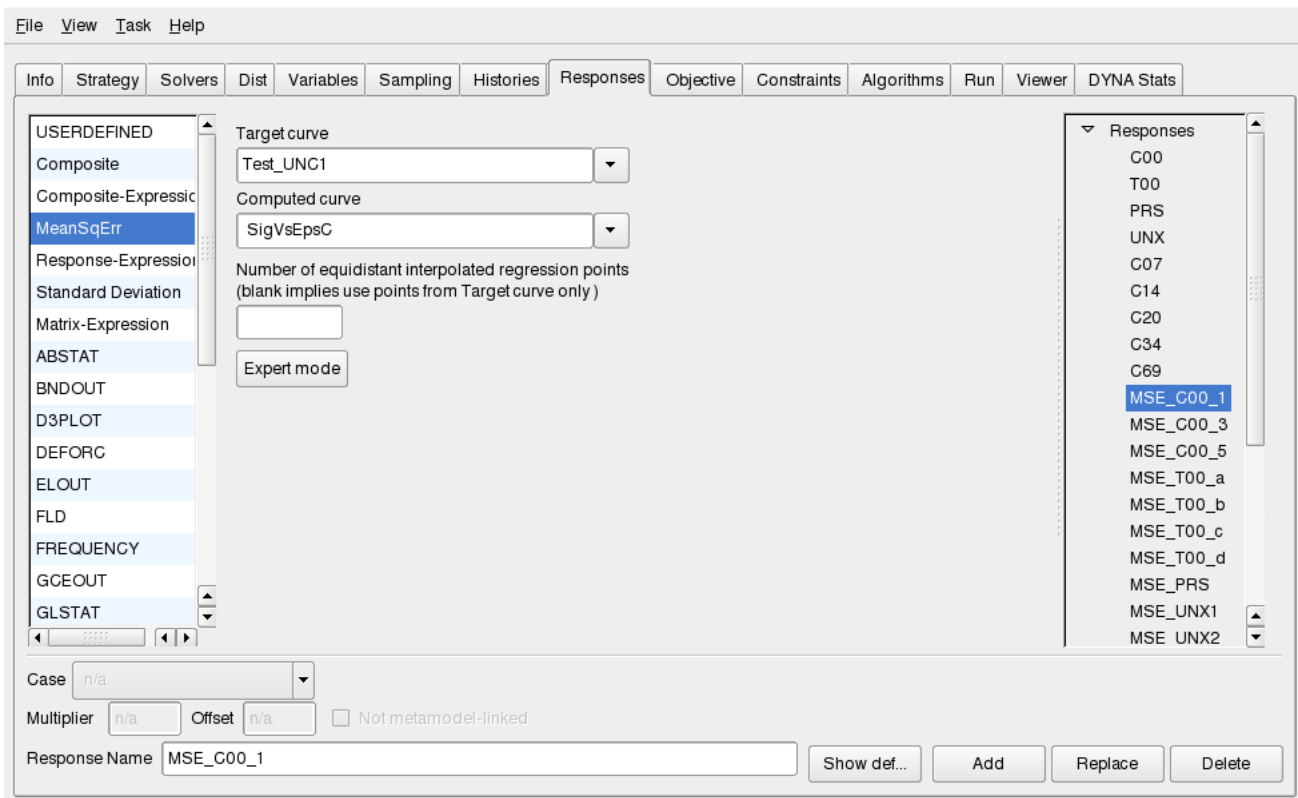
```
MeanSqErr (target_curve, computed_curve,
[num_regression_points, start_point, end_point,
weight_type, scale_type,
weight_value, scale_value,
weight_curve, scale_curve])
```

**Table 15-1: MeanSqErr arguments. Arguments in bold are obligatory.**

Argument name	Description	Symbol	LS-OPT Type	Default
<b>target_curve</b>	Target Curve name	$G(z)$	History	-
<b>computed_curve</b>	Computed curve name	$f(x,z)$	History	-
<i>num_regression_points</i>	Number of regression points	$P$	Int	If $P < 2$ or not specified: use number of points in target curve between lower limit and upper limit
<i>lower_limit</i>	Lower limit on $z$	$z_L$	Float	$z$ -Location of first target point
<i>upper_limit</i>	Upper limit on $z$	$z_U$	Float	$z$ -Location of last target point
<i>weight_type</i>	Weighting type	-	Reserved option name: WEIGHTVALUE PROPWEIGHT, FILEWEIGHT	WEIGHTVALUE (Value=1.0)
<i>scale_type</i>	Scaling type	-	Reserved option name: SCALEVALUE, PROPSCALE, MAXISCALE, FILESCALE	MAXISCALE
<i>weight_value</i>	Weight value	$W$	Float	1
<i>scale_value</i>	Scale value	$s$	Float	1
<i>weight_curve</i>	Weights as a function of $z$	$W(z)$	History	<code>Weight.compositename</code>
<i>scale_curve</i>	Scale factors as a function of $z$	$s(z)$	History	<code>Scale.compositename</code>

**Table 15-2: Options for MeanSqErr arguments**

Syntax	Explanation
WEIGHTVALUE	$W_i = value$ . Default = 1.0
PROPWEIGHT	Use a different weight for each curve point $p$ , proportional to the value of $ G_p $ . This method emphasizes the large absolute values of the response. The weights are normalized with respect to $\max  G_p $
FILEWEIGHT	Interpolate the weight from an x-y file: weight vs. $z$
SCALEVALUE	$s_i = value$ . Default = 1.0
MAXISCALE	$\max  G_p $ .
PROPSCALE	Use a different scale factor for each curve point, namely $ G_p $ .
FILESCALE	Interpolate the scale factor from an x-y file: scale vs. $z$



**Figure 15-2: Responses panel showing a MeanSqErr selection**

Note:

1. The MeanSqErr function can only be used as a composite.
2. Only points within range of both curves are included in Equation (13-3), so P will be automatically reduced during the evaluation if there are missing points. A warning is issued in WARNING\_MESSAGE.
3. If num\_regression\_points is unspecified, P equals the number of target points bounded by lower\_limit and upper\_limit.

4. The weight curve and scale curve must be predefined histories (see Section 14.1) if they are selected. If a weight or scale curve is selected, the name of the curve defaults to 'Weight.compositename' or 'Scale.compositename' respectively where compositename is the name of the parent composite being defined.
5. The MeanSqErr composite makes use of response surfaces to avoid the nonlinearity (quadratic nature) of the squared error functional. Thus if the response curve  $f(\mathbf{x})$  is linear in terms of the design variables  $\mathbf{x}$ , the composite function will be exactly represented.
6. Empty or underscore (`_`) arguments will generate default values.
7. The option names in Table 15-2 are reserved names and cannot be used as variable names.
8. MeanSqErr composites can be added together to make a larger MSE composite (e.g. for multiple test cases).

The simplest case, and probably the one used most frequently, is where the user simply defines only the target curve and corresponding computed curve (therefore only the first two arguments). In this case all the points in the target curve are taken as regression points (provided they have corresponding computed points). The simplest target curve that can be defined has only one point.

*Examples:*

```
$ ----- CONSTANTS -----
-----
Constant 'Begin' 0.002
Constant 'End' 0.008
Constant 'numpoints' 4
$ ----- HISTORIES FROM BINOUT -----
-----
history 'Force1' "BinoutHistory -res_type rcforc -cmp z_force -id 1 -side
SLAVE"
history 'Force2' "BinoutHistory -res_type rcforc -cmp z_force -id 1 -side
SLAVE"
history 'Disp2' "BinoutHistory -res_type nodout -cmp z_displacement -id 288"
$ ----- HISTORIES FROM CROSSPLOTS -----
-----
history 'Force_Displ_Dflt' expression { Crossplot ("-Disp2", "Force2") }
history 'Force_Displ_to_Num' expression { Crossplot ("-Disp2", "Force2", 2) }
history 'Force_Displ_to_Beg' expression { Crossplot ("-Disp2", "Force2", 4,
0.002) }
history 'Force_Displ_to_End' expression { Crossplot ("-Disp2", "Force2", 4,
0.002, End) }
$ ----- HISTORIES FROM FILES -----
-----
history 'Test1' file "Test1"
history 'Test2' file "Test2"
history 'Test3' file "Test3"
history 'Weight.Weight_Scale_Curves' file "Weight.Weight_Scale_Curves"
history 'Scale.Weight_Scale_Curves' file "Scale.Weight_Scale_Curves"
history 'Scale.Wt_Scale_Curves2' file "Scale.Weight_Scale_Curves2"
history 'Weight_1' file "Weight_1"
history 'Scale_1' file "Scale_1"
history 'UnitWeight' file "UnitWeight"
```

```

$ ----- COMPOSITES -----
-----
composite 'Constant_weight' { MeanSqErr ( Test1, Force1,4, Begin, 8./1000,
WEIGHTVALUE, SCALEVALUE, 2.0, 1.0) }
composite 'Unit_weight_curve' { MeanSqErr ( Test1, Force1,4, Begin, .008,
WEIGHTCURVE, SCALEVALUE, 2.0, 1.0, UnitWeight) }
composite 'Weight_Scale_Curves' { MeanSqErr ( Test1, Force1, 4, Begin, .008,
WEIGHTCURVE, SCALECURVE) }
composite 'Wt_Scale_Curves2' { MeanSqErr ( Test1, Force1, 4, Begin, .008,
WEIGHTCURVE, SCALECURVE, _, _, Weight_1 ) }
composite 'Wt_Scale_Curves3' { MeanSqErr ( Test1, Force1, 4, Begin, End,
WEIGHTCURVE, SCALECURVE, _, _, Weight_1, Scale_1 ) }
composite 'Weight_Propscale' { MeanSqErr ( Test1, Force1, 4, Begin, End,
WEIGHTCURVE, PROPSCALE, _, _, Weight_1) }
composite 'Dfltwt_Scalecurve' { MeanSqErr ( Test1, Force1, 4, Begin, End, ,
SCALECURVE, _, _, Weight_1, Scale_1 ) }
composite 'Dfltwt_Propscale' { MeanSqErr ( Test2, Force2, 4, 0.002, , ,
PROPSCALE) }
composite 'Dfltwt_Propscale2' { MeanSqErr ( Test2, Force2, 4, , .008, ,
PROPSCALE) }
composite 'Unitwt_Unitscale1' { MeanSqErr ( Test1, Force1, numpoints, Begin,
.008, WEIGHTVALUE, SCALEVALUE) }
composite 'Unitwt_Unitscale2' { MeanSqErr ( Test2, Force2, numpoints, Begin,
.008, WEIGHTVALUE, SCALEVALUE) }
composite 'Unitscale' { MeanSqErr ( Test2, Force2, 4, Begin, .008, _ ,
SCALEVALUE) }
composite 'Defaults_to_end' { MeanSqErr ( Test2, Force2, 4, Begin, .008) }
composite 'Defaults_to_begin' { MeanSqErr ( Test2, Force2, 4, Begin) }
composite 'Defaults_to_num' { MeanSqErr ( Test2, Force2, 4) }
composite 'Defaults1' { MeanSqErr ( Test1, Force1 ) }
composite 'Defaults2' { MeanSqErr ( Test2, Force2 ) }
composite 'Defaults3' { MeanSqErr ( Test3, Force_Disp_Dflt ) }

```

## 15.6.2. Curve Mapping

Please refer to Section 5.3.2 for the theory of Curve Mapping.

### Expression syntax:

---

**CurveMapSegment3** (*target\_curve*, *computed\_curve*)

---

**Table 15-3: CurveMapSegment3 arguments. Arguments in bold are obligatory.**

Argument name	Description	Symbol	LS-OPT Type	Default
<b>target_curve</b>	Target Curve name	$G(z)$	History	-
<b>computed_curve</b>	Computed curve name	$f(x,z)$	History	-

*Note:*

1. The `CurveMapSegment3` function can only be used as a composite.
2. It is recommended that both curves be filtered before matching to obtain curves which are as noise-free as possible. This avoids discrepancies in curve length which will affect the result. A general history filtering feature is available (see Section 14.1.3).

*Example:*

```
history 'Disp1' "BinoutHistory -res_type nodout -cmp z_displacement -id 296 "  
history 'Forc1' "BinoutHistory -res_type RCForc -cmp z_force -id 1 -side SLAVE"  
history 'F1_vs_d1' expression {Crossplot("-Disp1","Forc1")}  
history 'Test1' "Test1.txt"  
$  
composite 'MSE1' {CurveMapSegment3(Test1,F1_vs_d1)}  
$  
objective 'MSE1'
```

# 16. Objectives and Constraints

This chapter describes the specification of objectives and constraints for the design formulation.

## 16.1. Formulation

Multi-criteria optimal design problems can be formulated. These typically consist of the following:

3. Multiple objectives (multi-objective formulation)
4. Multiple constraints.

Mathematically, the problem is defined as follows:

$$\text{Minimize} \quad F(\Phi_1, \Phi_2, \dots, \Phi_N)$$

subject to

$$\begin{aligned} L_1 &\leq g_1 \leq U_1 \\ L_2 &\leq g_2 \leq U_2 \\ &\vdots \\ L_m &\leq g_m \leq U_m \end{aligned}$$

where  $F$  represents the multi-objective function,  $\Phi_i = \Phi_i(x_1, x_2, \dots, x_n)$  represent the various objective functions and  $g_j = g_j(x_1, x_2, \dots, x_n)$  represent the constraint functions. The symbols  $x_i$  represents  $n$  design variables.

In order to generate a trade-off design curve involving objective functions, more than one objective  $\Phi_i$  must be specified so that the multi-objective

$$F = \sum_{k=1}^N \omega_k \Phi_k. \quad (16-1)$$

A component function must be assigned to each objective function where the component function can be defined as a *composite function*  $F$  (see Section 15.4) or a *response function*  $f$ . The number of objectives,  $N$ , must be specified in the problem description (see Section 8.2).



## 16.2. Defining an objective function

This command identifies each objective function. The name of the objective is the same as the component, which can be a response or composite.

### Command file syntax:

---

```
objective name { weight <1> }
```

---

#### Examples:

```
objective 'Intrusion_1'
objective 'Intrusion_2' 2.
objective 'Acceleration' 3.
```

for

$$\begin{aligned} \text{Multi-objective : } F &= \Phi_1 + 2\Phi_2 + 3\Phi_3 \\ &= F_1 + 2F_2 + 3F_3. \end{aligned}$$

#### Remarks:

1. The distinction between objectives is made solely for the purpose of constructing a Pareto-optimal curve involving multiple objectives (see Section 4.9).
2. The selection to create a Pareto Optimal Frontier is done in the Strategy panel (see Section 4.5).
3. Objectives can be specified in terms of composite functions and/or response functions.
4. The weight applies to each objective as represented by  $\omega_k$  in Equation (11.1).

The default is to minimize the objective function. The program can however be set to maximize the objective function. In LS-OPT $_{ui}$ , maximization is activated in the Objective panel.

### Command file syntax:

---

Maximize

---

#### Example:

```
Response 'Mass' "DynaMass 3 13 14 16 MASS"
Maximize
Objective 'Mass'
Constraint 'Acceleration'
```

In LS-OPT $_{ui}$ , objectives are defined in the Objective panel (Figure 16-1):

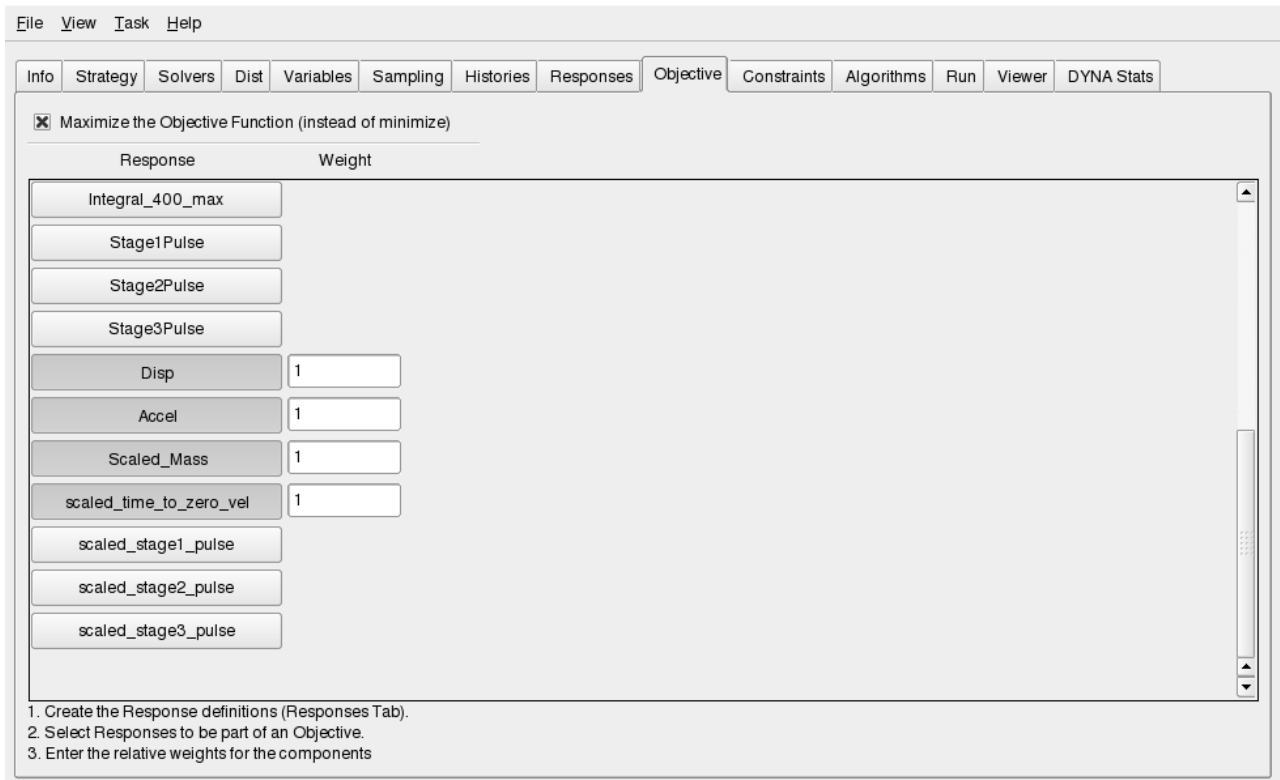


Figure 16-1: Objective panel in LS-OPTui with maximization selection.

### 16.3. Defining a constraint

This command identifies each constraint function. The constraint has the same name as its component. A component can be a response or composite.

#### Command file syntax:

---

```
constraint constraint_name
```

---

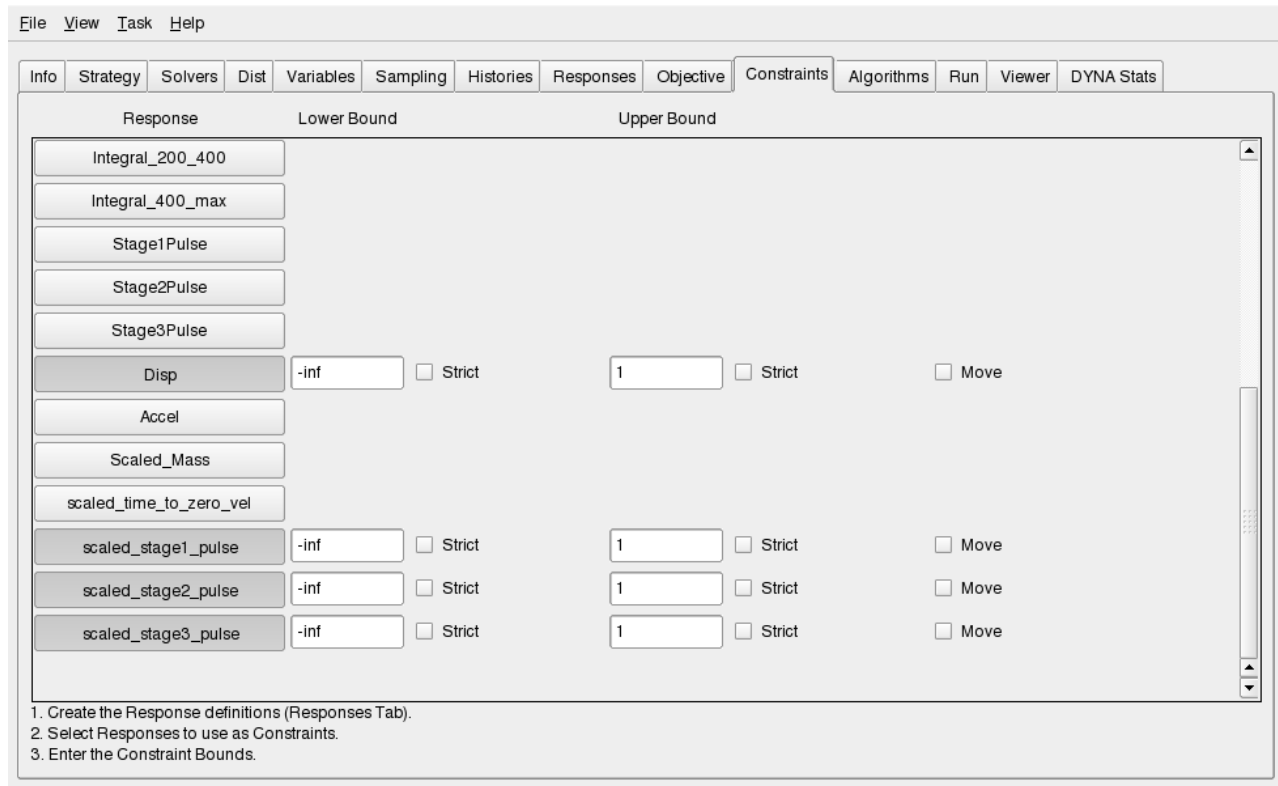
#### Examples:

```
history 'displacement_1' "DynaASCII nodout 'r_disp' 12789 TIMESTEP 0.0 SAE
60"
history 'displacement_2' "DynaASCII nodout 'r_disp' 26993 TIMESTEP 0.0 SAE
60"
history 'Intrusion' {displacement_2 - displacement_1}
response Intrusion_80 {Intrusion(80)}
constraint 'Intrusion_80'
```

#### Remark:

1. Constraints can be specified in terms of response functions or composite functions.

In LS-OPTui, constraints are defined in the Constraints panel (Figure 16-2):



**Figure 16-2: Constraints panel in LS-OPTui**

## 16.4. Bounds on the constraint functions

Upper and lower bounds may be placed on the constraint functions. Additionally, for Reliability Based Design Optimization, the probability of exceeding a bound on a constraint can be set.

### Command file syntax:

---

```
lower bound constraint constraint_name value <-10+30>
upper bound constraint constraint_name value <+10+30>
probability lower bound constraint constraint_name prob_value
probability upper bound constraint constraint_name
prob_value
```

---

#### Example:

```
Lower bound constraint 'Stress' 1.e-6
Upper bound constraint 'Stress' 20.2
```

*Remark:*

1. A flag can be set to identify specific constraint bounds to define a reasonable design space. For this purpose, the `move` environment must be specified (See Section 13.8).

## 16.5. Minimizing the maximum response or violation\*

Refer to Section 5.1 for the theory regarding strict and slack constraints. To specify hard (strict) or soft (slack) constraints, the following syntax is used:

### Command file syntax:

---

```
strict strictness_factor <1>
slack
```

---

Each command functions as an environment. Therefore all lower bound constraint or upper bound constraint commands which appear after a strict/slack command will be classified as strict or slack.

In the following example, the first two constraints are slack while the last three are strict. The purpose of the formulation is to compromise only on the knee forces if a feasible design cannot be found.

*Example:*

```
$ This formulation minimizes the average knee force but
$ constrains the forces to 6500.
$ If a feasible design is not available, the maximum violation
$ will be minimized.
$
$ Objective:
$-----
composite 'Knee_Forces' type weighted
composite 'Knee_Forces' response 'Left_Knee_Force'    0.5
composite 'Knee_Forces' response 'Right_Knee_Force'   0.5
objective 'Knee_Forces'
$
$ Constraints:
$-----
SLACK
Constraint 'Left_Knee_Force'
Upper bound constraint 'Left_Knee_Force'    6500.
$
Constraint 'Right_Knee_Force'
Upper bound constraint 'Right_Knee_Force'   6500.
$
STRICT
Constraint 'Left_Knee_Displacement'
Lower bound constraint 'Left_Knee_Displacement'  -81.33
$
Constraint 'Right_Knee_Displacement'
Lower bound constraint 'Right_Knee_Displacement' -81.33
```

```

$
Constraint 'Kinetic_Energy'
Upper bound constraint 'Kinetic_Energy'      154000.

```

The `composite` function is explained in Section 15.3. Note that the same response functions appear both in the objective and the constraint definitions. This is to ensure that the violations to the knee forces are minimized, but if they are both feasible, their average will be minimized (as defined by the composite).

The constraint bounds of all the soft constraints can also be set to a number that is impossible to comply with, e.g. zero. This will force the optimization procedure to always ignore the objective and it will minimize the maximum response.

In the following example, the objective is to minimize the maximum of 'Left Knee Force' or 'Right Knee Force'. The displacement and energy constraints are strict.

*Example:*

```

$ This formulation minimizes the maximum knee force
$ Because the knee forces are always positive,
$ the objective will be ignored and the knee force
$ minimized
$$
$ Objective:
$-----
composite 'Knee_Forces' type weighted
composite 'Knee_Forces' response 'Left_Knee_Force'      0.5
composite 'Knee_Forces' response 'Right_Knee_Force'     0.5
objective 'Knee_Forces'
$
$ Constraints:
$-----
SLACK
Constraint 'Left_Knee_Force'
Upper bound constraint 'Left_Knee_Force'      0.
$
Constraint 'Right_Knee_Force'
Upper bound constraint 'Right_Knee_Force'     0.
$
STRICT
Constraint 'Left_Knee_Displacement'
Lower bound constraint 'Left_Knee_Displacement' -81.33
$
Constraint 'Right_Knee_Displacement'
Lower bound constraint 'Right_Knee_Displacement' -81.33
$
Constraint 'Kinetic_Energy'
Upper bound constraint 'Kinetic_Energy'      154000.

```

Remarks:

1. The objective function is ignored if the problem is infeasible.
2. The variable bounds of both the region of interest and the design space are always hard.
3. Soft constraints will be strictly satisfied if a feasible design is possible.
4. If a feasible design is not possible, the most feasible design will be computed.
5. If feasibility must be compromised (there is no feasible design), the solver will automatically use the slackness of the soft constraints to try and achieve feasibility of the hard constraints. However, there is always a possibility that hard constraints must still be violated (even when allowing soft constraints). In this case, the variable bounds may be violated, which is highly undesirable as the solution will lie beyond the region of interest and perhaps beyond the design space. This could cause extrapolation of the response surface or worse, a future attempt to analyze a design which is not analyzable, e.g. a sizing variable might have become zero or negative.
6. Soft and strict constraints can also be specified for search methods. If there are feasible designs with respect to hard constraints, but none with respect to all the constraints, including soft constraints, the most feasible design will be selected. If there are no feasible designs with respect to hard constraints, the problem is ‘hard-infeasible’ and the optimization terminates with an error message.

## 16.6. Internal scaling of constraints

Command file syntax:

---

```
Constraint constraint_name scale lower bound value <1.0>
Constraint constraint_name scale upper bound value <1.0>
```

---

Constraints can be scaled internally to ensure normalized constraint violations. This may be important when having several constraints and an infeasible solution so that when the maximum violation over the defined constraints is minimized, the comparison is independent of the choice of measuring units of the constraints. The scale factor  $s_j$  is applied internally to constraint  $j$  as follows:

$$\frac{-g_j(x) + L_j}{s_j^L} \leq 0; \frac{g_j(x) - U_j}{s_j^U} \leq 0.$$

A logical choice for the selection of  $s$  is  $s_j^L = L_j$  and  $s_j^U = U_j$ , so that the above inequalities become

$$\frac{-g_j(x)}{L_j} + 1 \leq 0; \frac{g_j(x)}{U_j} - 1 \leq 0.$$

internally and in the infeasible phase:

$$\frac{-g_j(x)}{L_j} + 1 \leq e; \frac{g_j(x)}{U_j} - 1 \leq e; e \geq 0.$$

*Example:*

Constraint 'Left\_Knee\_Displacement'

Lower bound constraint 'Left\_Knee\_Displacement' -81.33

Constraint 'Left\_Knee\_Displacement' scale lower bound 81.33

# 17. Running the Design Task

This chapter explains simulation job-related information and how to execute a design task from the graphical user interface.

The available tasks are optimization, probabilistic evaluation, and repair of an existing job.

## 17.1. Optimization

The optimization process is triggered by the `iterate` command in the input file or by the `Run` command in the `Run` panel in `LS-OPTui` (Figure 17-1). The optimization history is written to the `OptimizationHistory` file and can be viewed using the `Viewer` panel.

### 17.1.1. Number of optimization iterations

The number of optimization iterations is specified in the appropriate field in the `Run` panel. If previous results exist, `LS-OPT` will recognize this (through the presence of results files in the `Run` directories) and not rerun these simulations. If the termination criteria described below are reached first, `LS-OPT` will terminate and not perform the maximum number of iterations.

#### Command file syntax:

---

```
iterate maximum_ number_ of_ iterations
```

---

### 17.1.2. Optimization termination criteria

The user can specify tolerances on the design change ( $\Delta x_i$ ), the objective function change ( $\Delta f$ ) and the accuracy of the metamodel. The user can also specify whether termination is reached if any one (*or* condition), or all (*and* condition) of these criteria are met. The default selection is *and*, but the user can modify this by selecting *or*.

The tolerance on the metamodel accuracy is based on the *change* of the prediction accuracy measure (square root of the `PRESS` error). The measure is divided by the mean of the simulated values used to construct the response surface unless this mean is zero. The value of the most critical response is used.

Refer to Section 20.4.1 for the modification of the stopping type in the `Command File`.



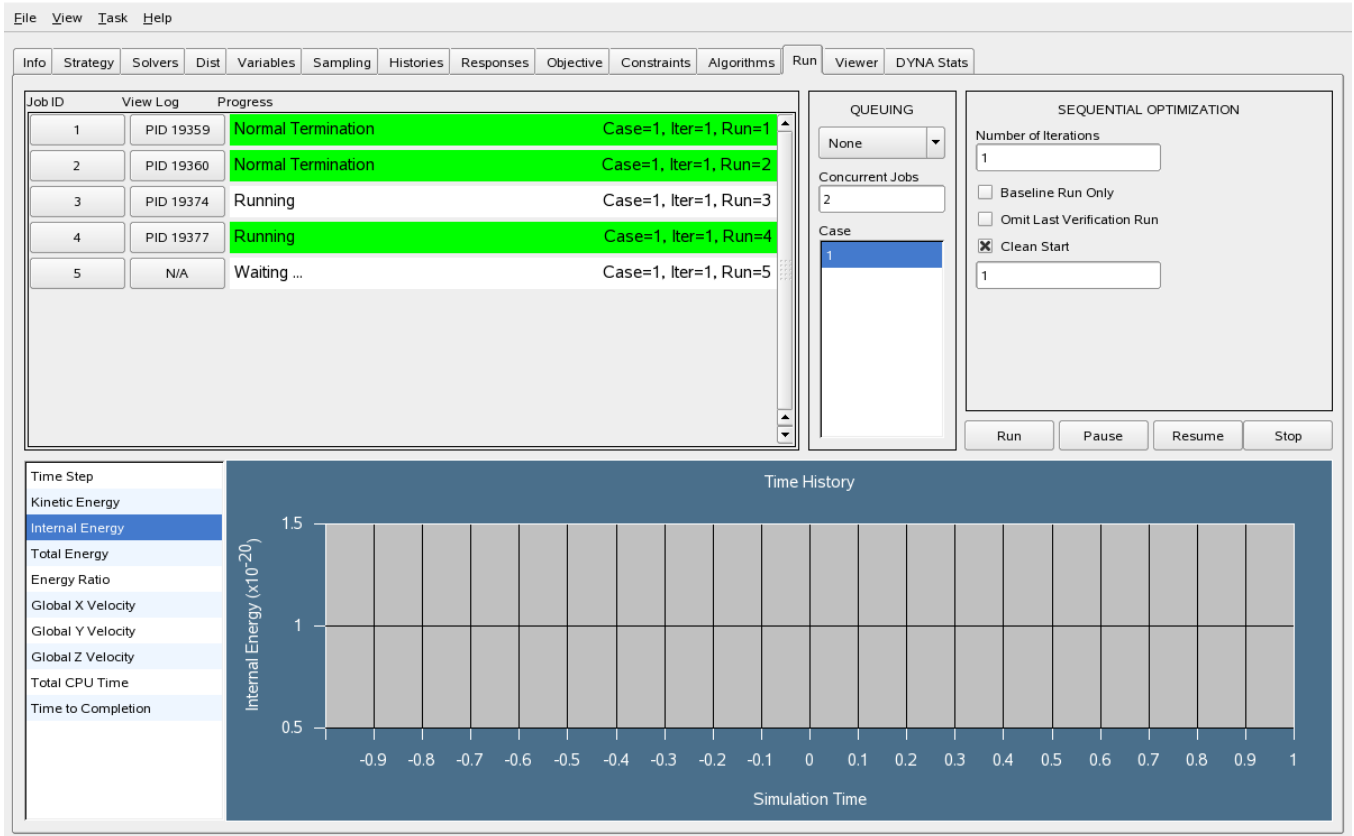


Figure 17-1: Run panel in LS-OPTui

## 17.2. Probabilistic evaluation

Both a Monte Carlo and a metamodel-based Monte Carlo evaluation can be scheduled from the user interface. The task must be set to the relevant procedure.

Section 12.4 regarding probabilistic evaluation contains more details on the available options.

The results can be viewed using the View panel. The histogram, tradeoff, and covariance plots are pertinent to a pure Monte Carlo analysis. For a metamodel-based Monte Carlo evaluation, the accuracy, ANOVA, and stochastic contribution plots are relevant in addition to the histogram, tradeoff, and covariance plots.

The LS-DYNA results can be investigated for possible bifurcations using the tools described in chapter 21.

### 17.3. Restarting

When a solution is interrupted (through the Stop button) or if a previous optimization run is to be repeated from a certain starting iteration, this can be accomplished by using the option “Clean Start” in the Run panel (Figure 17-1). This option requires the user to provide iteration number from which the simulations are restarted. It is important to note that the clean-start option removes all simulation data as well as optimization data from the specified iteration onwards.

### 17.4. Baseline run only

This feature provides the user with an option to run a single design, sampled at the initial values specified in the variables panel. The simulations are always carried out in the directory **1.1** for respective disciplines. This option facilitates a verification of the design and optimization problem in LSOPT i.e.,

1. checks for the correct solver command,
2. communication between the LSOPT and the queuing system, if any,
3. presence of all relevant control cards, database formats,
4. data extraction from simulation results, and
5. validity of responses and histories.

It is recommended to always perform a single simulation using “Baseline run only” option to debug the optimization problem in LSOPT.

### 17.5. Omit last verification run

If the user does not want to simulate the predicted optimum at the end of simulation, she can use this option to avoid the final verification run. The predicted optimum is reported as the final design.

### 17.6. Job concurrency

When LS-OPT is run on a multi-processor machine, the user can select how many simulations (jobs) can run concurrently on different processors (see Figure 17-1). Only the solver process and response extraction are parallellized. The preprocessor processes run serially. The number of Concurrent Jobs is ignored for jobs that are run by a queuing system.

### 17.7. Job distribution

When a queuing system is available, its operation can be specified in the Run panel (Figure 17-1).

## 17.8. Job and analysis monitoring

The Run panel allows a graphical indication of the job progress with the green horizontal bars linked to estimated completion time. This progress is only available for LS-DYNA jobs. The job monitoring is also visible when running remotely through a supported job distribution (queuing) system.

When using LS-DYNA, the user can also view the progress (time history) of the analysis by selecting one of the available quantities (Time Step, Kinetic Energy, Internal Energy, etc.).

## 17.9. Pause and Resume

Selecting the *Pause* button in the Run tab will pause all the simulation jobs. Selecting the *Resume* button will resume these jobs.

## 17.10. Repair or modification of an existing job

Several kinds of repairs and modifications are possible for an existing optimization iteration or a probabilistic analysis. The repair depends on the LSOPT database files as described in Section 4. The available repair tasks are:

- *Read points.* The *CASE/Experiments.iteration* file is reconstructed from the runs executed. The experimental points can be extracted from the database in the job directories and the experimental design thereby reconstructed.
- *Augment points of a Metamodel-based analysis.* Points are added to the existing experimental design. This option is only available for the following experimental designs types: D-Optimal, space-filling, random, and Latin Hypercube. The D-Optimal and space-filling experimental designs will be computed taking in consideration the previously computed points. Both the random and the Latin Hypercube experimental design points will be computed using the number of previously computed points as a seed to the random number generator. If an experimental design does not exist, new points will be created.
- *Augment Points of a Monte Carlo analysis.* Points are added to the existing experimental design. This option is only available for the following experimental designs types: random and Latin Hypercube. Both the random and the Latin Hypercube experimental design points will be computed using the number of previously computed points as a seed to random number generator.
- *Run Jobs.* The LS-DYNA jobs will be scheduled. Designs previously analyzed will not be analyzed again.
- *Rerun failed jobs.* The jobs that failed to run will be resubmitted. The LS-DYNA input file used will be regenerated from the files specified in the main directory. The preprocessor, if one is specified, will be rerun.
- *Extract Results.* The results will be extracted from the runs. This option also allows the user to change the responses for an existing iteration or Monte Carlo analysis.
- *Import results (.csv).* Import results from a .csv (comma separated variables) file (see Section 17.12).

- *Build Metamodels.* The metamodels will be built. This option also allows revision of the metamodels for an existing iteration or Monte Carlo analysis. The “ExtendedResults” file will be updated. Metamodels can for instance be built from imported user results (see section on *Read user results* above).
- *Evaluate Metamodels.* Create a table with the error measures of a given set of points (Section 13.11) or create a table (.csv file) with response values interpolated from a metamodel (Section 13.12).
- *Optimize.* The metamodels are used for metamodel optimization. A new optimum results database is created. The “ExtendedResults” file will be updated. The optimization history database is deleted so the history will not be displayed in the Viewer.

*Remarks:*

1. All the subsequent operations must be explicitly performed for the iteration. For example, augmenting an experimental design will not cause the jobs to be run, the results to be extracted, or the metamodels to be recomputed. Each of these tasks must be executed separately.
2. After repair of iteration  $n$ , and if the user is conducting an optimization task, verification runs of the optimized result must be done by switching back to the Metamodel-based optimization task and specifying the starting iteration as  $n+1$  for a new run. If  $n+1$  was a full iteration (not just a verification run), it also has to be repaired.

**Command file syntax:**

---

```
read experiments iteration_number
design more metamodel iteration_number
design more monte carlo iteration_number
run iteration_number
run failed iteration_number
extract results iteration_number
read user results iteration_number
approximate iteration_number
check file iteration_number
optimize iteration_number
```

---

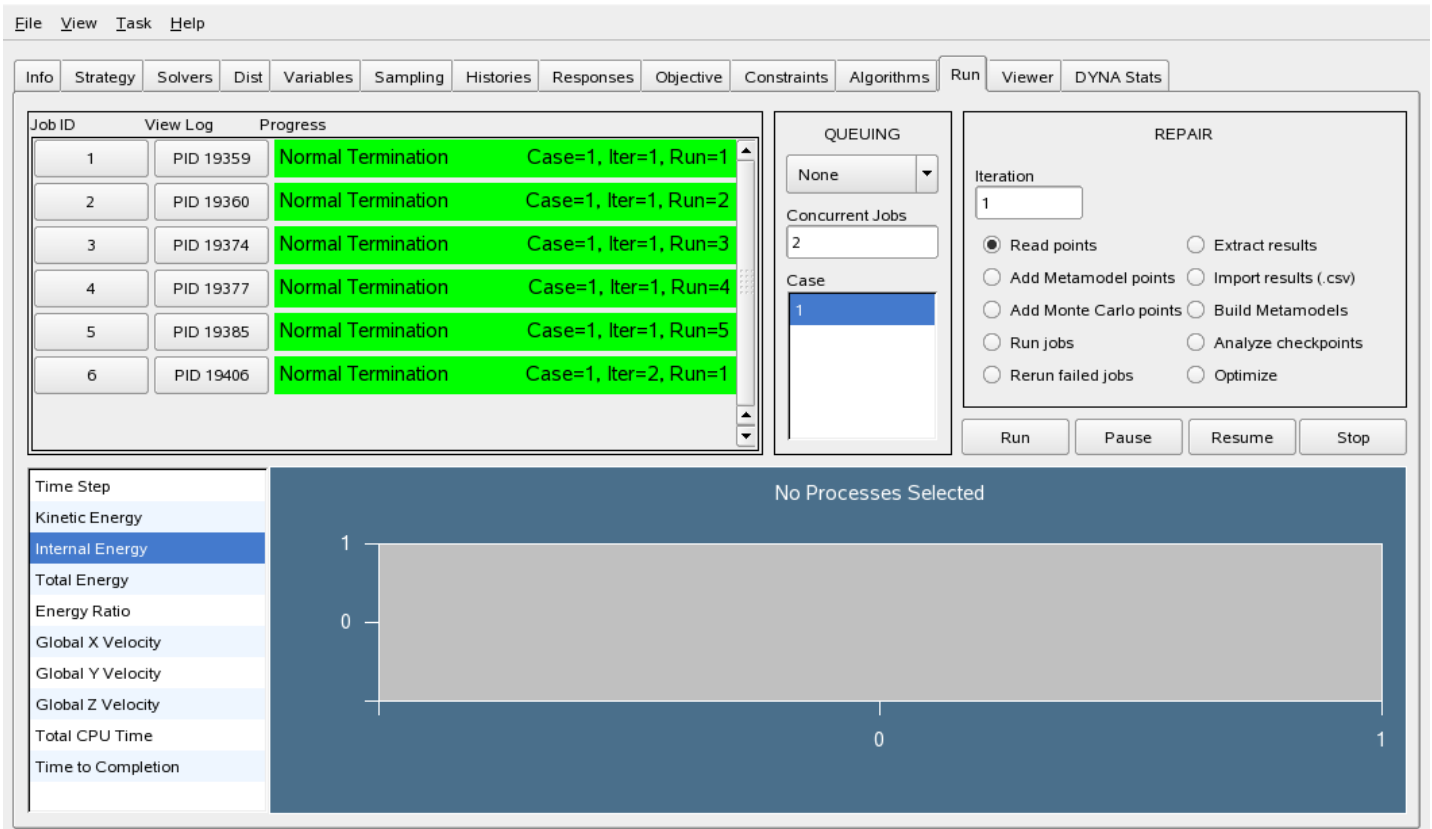


Figure 17-2: Repair panel

## 17.11. Tools

A number of tools are available for miscellaneous operations:

- *Clean*. The directory structure created by LS-OPT and all files in this directory structure are deleted.
- *Archive LS-OPT database*. See Section 17.13. This option collects relevant files and creates a single tar-zipped (on \*nix operating systems) file or zipped (on windows operating systems) file. Users can also add more database files using the following options:
- *Include Histories and Responses*. History and response files are required for the DynaStats panel and to view the curve matching results (comparison of the test and computed histories). See Section 17.13.
- *Include Input Deck/Extra Files*. Various input files and other files required to run the LSOPT job seamlessly are added to the packed database file.

### Command file syntax:

```
clean
pack database
pack database input
```

---

 pack database histories
 

---

## 17.12. Importing user-defined analysis results

A table (in text form) of existing analysis results can be used for analysis. The command to import the file is given as:

### Command file syntax:

---

```
solver response user filename_csv_format
```

---

#### Example:

```
solver response user "/home/test/ImportResults/crash2.csv"
```

An example of a analysis results file (with 2 simulation points) is:

```
"var1", "var2", "var3", "Displacement", "Intrusion", "Acceleration"
"dv", "dv", "nv", "rs", "rs", "rs"
1.23 2.445 3.456 125.448 897.2 223.0
0.01,2.44,1.1,133.24,244,89,446.6
```

Two header lines are required. The first header line contains the variable names. The second header line contains the variable types. The following lines contain the variable and response values for each design point. The types are defined as:

Symbol	Explanation
dv	Design variable
nv	Noise variable
rs	Response
sk	Ignore

The parsing code looks for *double quotes*, *commas*, *spaces* and/or *tabs* as delimiters.

The steps for importing user-defined analysis result files using the GUI are as follows:

3. *Solvers panel*: Browse for the text file in the "Import User Results" tab. The browser has a preference for `.csv` and `.txt` files.
4. Specify a name for the analysis case and "Add" the case.
5. *Variables and Responses panels*. To import the variables and responses into the GUI, it is required to click on the Variables and Responses tabs. The variables and responses will be displayed and automatically associated with the correct analysis case.

6. *Sampling panel.* Check that the number of points defined in the sampling panel is the same as the number of points in the user-provided file. If fewer points are available in the file, LS-OPT will augment the sampling points and try to run simulations.
7. *Menu bar.* Choose the "Repair" task.
8. *Run panel.* In "Repair" mode, select "Import results (.csv)" and "Run". This is a critical step to convert the `.csv` format to the LS-OPT database format ready for analysis.
9. The user can now choose the type of analysis.
  - DOE Study: Change to the "Metamodel-based DOE Study" task and "Run". Metamodels will be created and the Viewer can be used to study the metamodel results.
  - Optimization:

Define the Objectives and/or constraints. For RBDO, define the distributions for the input variables as well as the probability of failure.

Change to the "Metamodel-based Optimization" or "Metamodel-based RBDO" task, choose the "Single Stage" strategy and "Run". An optimization history is created.

### **17.13. Saving/compressing the LS-OPT database after completing a run**

Using the Tools function, the database can be gathered up and compressed in a file called `lsopack.tar.gz` (`lsopack.zip` in Windows). The packed database is suitable for post-processing on any computer platform. The repair selection is: *Archive LS-OPT database*.

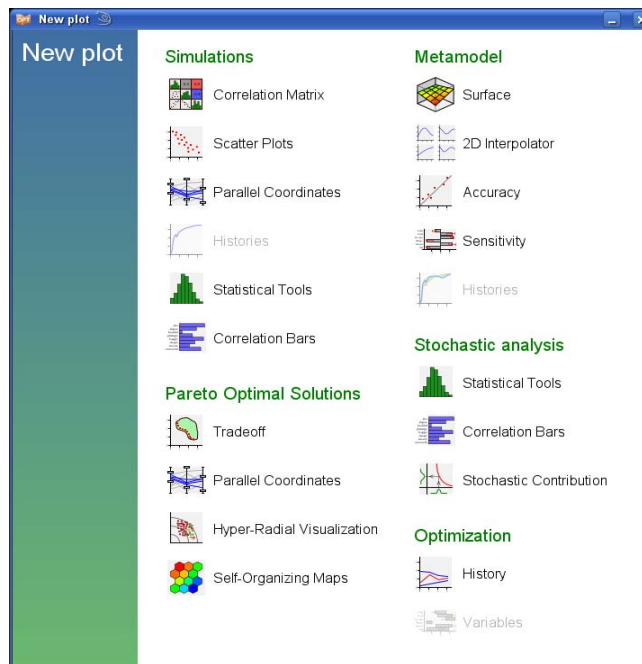
More sophisticated options are available to also gather the history and response files residing in the run directories and all input files. The history/response files (e.g. `history.0`, etc.) are required to view history plots in the DynaStats panel and also for viewing curve matching results in the Viewer. The selection is: *Archive LS-OPT database + histories/responses*. The file produced is `lsopack_h.tar.gz` (`lsopack_h.zip` in Windows). The addition of input decks only results in `lsopack_i.tar.gz` (`lsopack_i.zip` in Windows) and inclusion of both histories and input decks results in `lsopack_h_i.tar.gz` (`lsopack_h_i.zip` in Windows).

# 18. Viewing Results

This chapter describes the post-processing of LS-OPT result data using the Viewer panel in LS-OPTui.

## 18.1. Viewer overview

### 18.1.1. Plot Selector



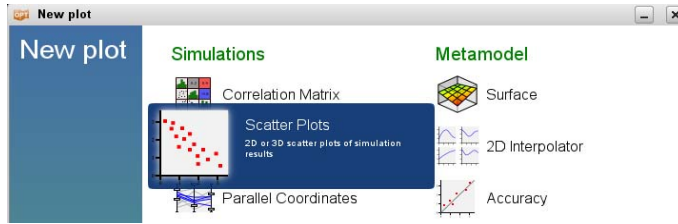
**Figure 18-1: Plot Selector**

The plots are grouped into five categories, Figure 18-1,

- Simulations,
- Metamodel,
- Optimization,
- Pareto Optimal Solutions and
- Stochastic Analysis.

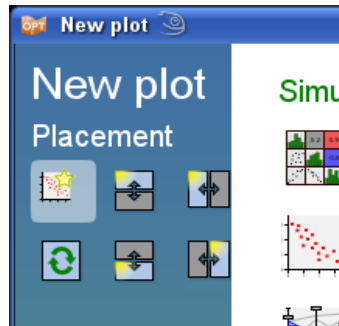
Depending on the optimization task, the selected options and the database availability, categories are hidden or plots are disabled.








**Figure 18-2: Plot Selector with additional plot information**

Moving the mouse on a plot type gives additional information on the plot, Figure 18-2.



**Figure 18-3: Selection for placement of new plot in the plot selector**

If plots already exist, the placement of the new plot may be specified in the plot selector, Figure 18-3. The default is to create a new plot. All available options are explained in Table 18-1. For details see Section 18.1.5.

	Create a new plot window
	Replace current plot
	Split window and place new plot at the highlighted position














**Table 18-1: Plot placement options**

### 18.1.2. General Plot Options

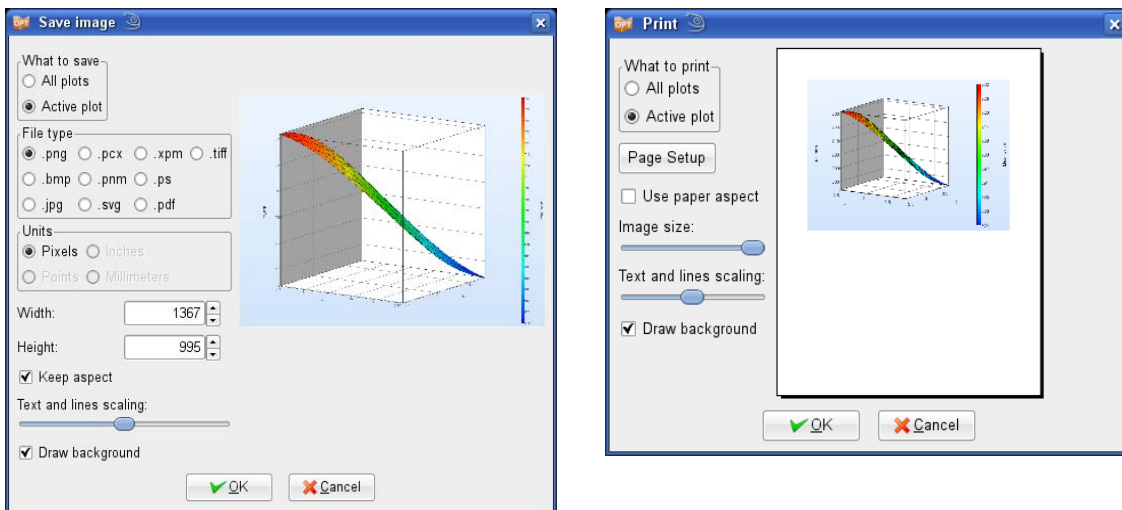
General plot options are available on the toolbar at the top of the plot window, Figure 18-1. Table 18-2 explains the options.



**Figure 18-4: General options**

	New plot	Opens Plot Selector with placement selection for the new plot, see Section 18.1.1.
	Delete plot	Deletes active plot
	Save plot setup	Saves current plot setup to be reused later, see Section 18.1.6.
	Pointer tool [F1]	Rectangular selection (rubber-banding) in plot or clicking marks points or curves and opens Point selection window, see Section 18.1.4.
	Zoom in tool [F2]	Rectangular selection in plot specifies zoom region
	Zoom out [F3]	Clicking on plot zooms out
	Reset zoom	Resets plot to initial range
	Split vertical	Splits plot window vertical, see Section 18.1.5.
	Split horizontal	Splits plot window horizontal, see Section 18.1.5.
	Print	Prints the current plot, options see Figure 18-5.
	Save image	Saves the current plot, options see Figure 18-5.
	Visualize relations between controls and plots	If several plots are displayed in the same plot window, this option helps to find each plot's control panel.
	Point selection window	Shows or hides a window that shows the values of all entities for the selected points in a table. This window shows up automatically if the point selection changes, see section 18.1.4.

**Table 18-2: General plot options**



**Figure 18-5: Options for printing (right) and saving (left) images**

### 18.1.3. Plot Rotation

For all 3D plots, image rotation is performed by holding down the Ctrl key while moving the mouse (same as LS-PREPOST).

### 18.1.4. Point Selection

The points on Scatter, TradeOff, Surface, Accuracy, Optimization History and HRV plots, and lines on PCP, History plots may be selected by clicking on a single point or by selecting several points within a rectangular box. The selected points are highlighted in the plot and the computed and predicted values of all entities for the selected points are displayed in a spreadsheet in a separate plot selection window, Figure 18-6. Options for point selection are explained in Table 18-3. Points may also be selected from the list of all points available in the current plots on the left in the Point selection window.

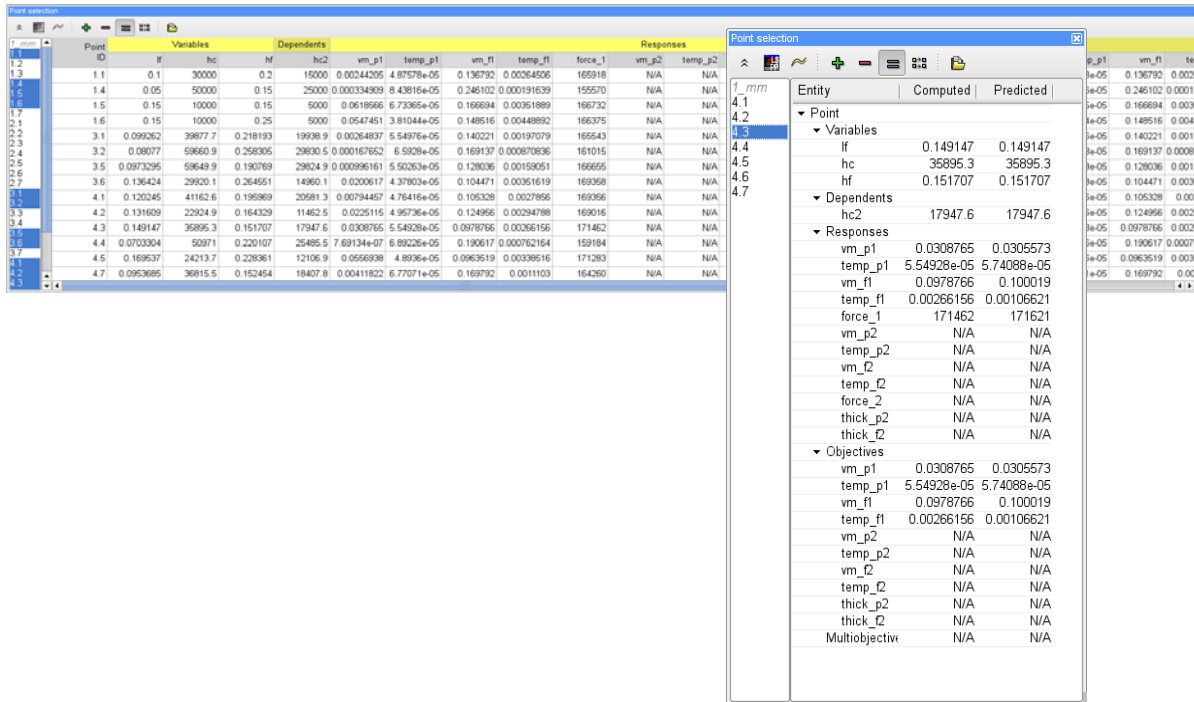


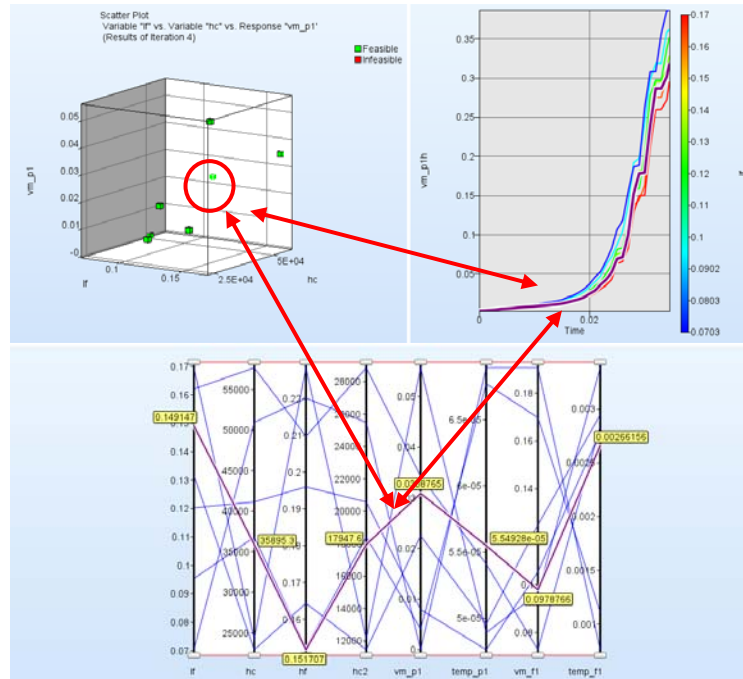
Figure 18-6: Point selection window for single (front) and multi (background) point selection

	Open selected run in LS-PREPOST	This option is only available for LS-DYNA simulations, if the d3plot or d3eigv database is available
	Display histories involved in a curve matching composite	This option is only available if MeanSqErr composites are defined. It is recommended to use the history plot feature (Section 18.2.4) for comparing histories (including file-based histories typically used with curve matching).
	Add to set of selected points	Options for new point selection
	Subtract from set of selected points	
	Replace set of selected points	
	Toggle set of selected points (within rectangle)	
	Export as text file (.csv)	

**Table 18-3: Point selection options**

The SOM plot also supports selection. If a cell is selected, all points that are mapped to the selected cell are displayed in the point selection window.

Point selection is integrated, hence selected points are highlighted in all plots within the same plot window.

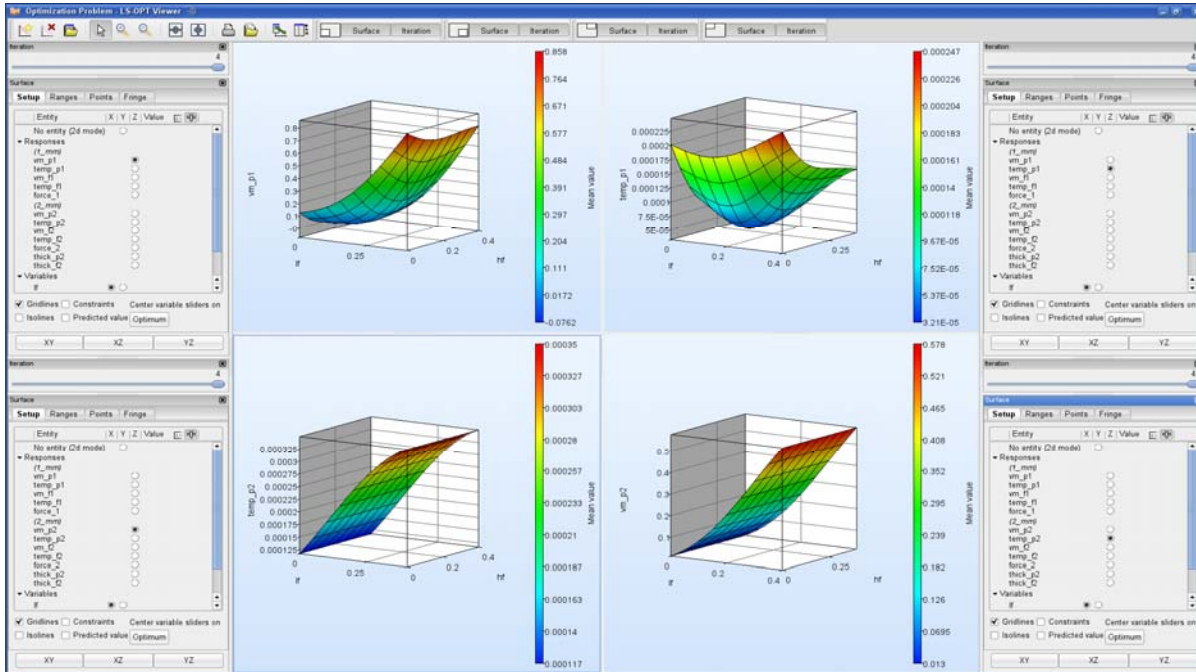


**Figure 18-7: Cross-display of selected points**

### 18.1.5. Split Window

To display several plots side by side, there are two basic selections available to split the plot window. (i) options to split the window horizontally or vertically in the toolbar at the top of the plot window or (ii) select the new plot together with a placement option for the new plot in the Plot Selector.

If the split window options are used, the same plot is repeated with the same settings which is useful for e.g., displaying 3D surface plots for different responses side by side, Figure 18-8.



**Figure 18-8: Example for split option**

If split window options are used several times, the plots may become too small, and as much as possible space on the screen is needed to get a good view. Hence all control panels are detachable or may even be hidden by pushing the respective button in the toolbar at the top of the plot window, Figure 18-9.

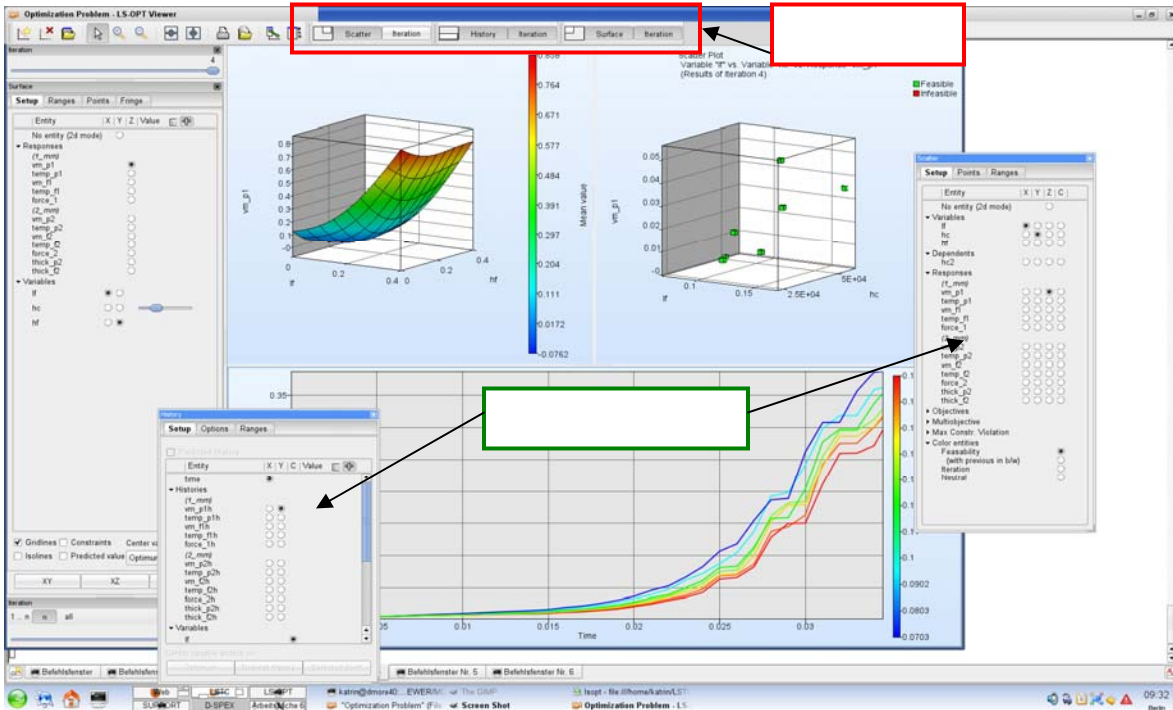


Figure 18-9: Detachable panels

### 18.1.6. Save Plot Setup

Window splitting and placement selection of new plots allows complex plot setups. To reuse a plot setup several times, even across problems, it may be saved. Later you can bring this plot state back by clicking on the preview in the plot selector, Figure 18-10.

The plot setup is stored in XML format in `~/LS-OPT Viewer/plotname.plot` on Linux machines. On Windows, the plot setup is stored in `Application Data\LS-OPT Viewer` in the user's home directory. The full path depends on the Windows version and setup, e.g. `C:\Documents and Settings\user\Application Data\LS-OPT Viewer`.

The command line option “-l” makes the viewer load a plot setup from a file immediately, without showing the plot selector. That makes it possible to write a script that generates the plot state XML file and then calls upon the viewer to display the plots. For more details on command line options, see Section 18.1.7.



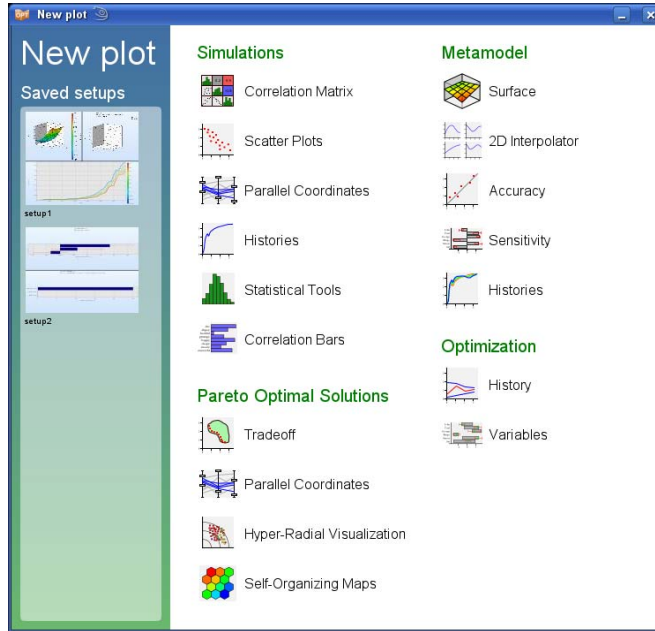


Figure 18-10: Plot Selector with previously saved setups

### 18.1.7. Command line options

The post-processing tool of LS-OPT may be started from the Viewer Panel in LS-OPTui, or the executable *viewer* located in the LS-OPT installation directory may be called from the command line:

```
viewer [-p <str>] [-l <str>] [-h] [--verbose] [com-file]
```

Table 18-4 explains the command line options.

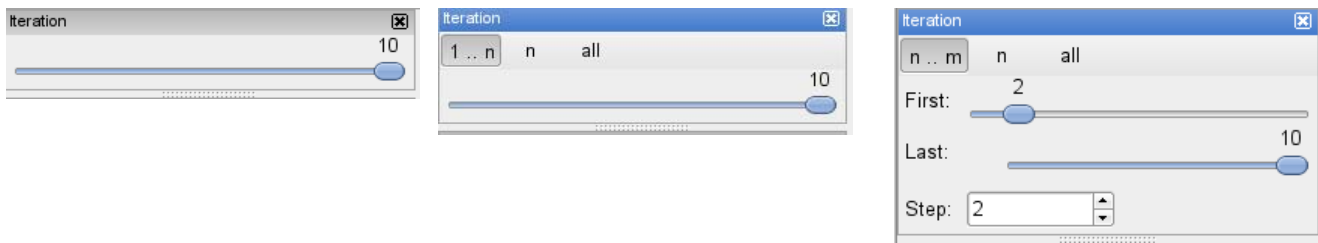
<p><code>-p &lt;str&gt;, --show-plot=&lt;str&gt;</code></p>	<p>Open the given plot, valid plot types are</p>	
	<i>accuracy</i>	Accuracy (Section 18.3.3)
	<i>correlation</i>	Correlation Bars (Section 18.2.6)
	<i>corrmatrix</i>	Correlation Matrix (Section 18.2.1)
	<i>history</i>	Histories – Metamodel (Section 18.3.5)
	<i>history_ar</i>	Histories – Simulations (Section 18.2.4)
	<i>hrv</i>	Hyper-Radial Visualization (Section 18.5.3)
	<i>interpol</i>	2D Interpolator (Section 18.3.2)
	<i>opthist</i>	Optimization History (Section 18.4.1)
	<i>parallelcoord</i>	Parallel Coordinates – Pareto Optimal Solutions (Section 18.5.2)
	<i>parallelcoord_ar</i>	Parallel Coordinate – Simulations (Section 18.2.3)
	<i>scatter</i>	Scatter Plots (Section 18.2.2)
	<i>sensitivities</i>	Sensitivity (Section 18.3.4)
	<i>som</i>	Self-Organizing Maps – Pareto Optimal Solutions (Section 0)
<i>statistics</i>	Statistical Tools (Section 18.2.5)	
<i>stoch</i>	Stochastic Contribution (Section 18.6.3)	
<i>surface</i>	Surface (Section 0)	

	<i>tradeoff</i>	Tradeoff (Section 18.5.1)
	<i>variable</i>	Variables (Section 18.4.2)
-l <str>, --load-setup=<str>	Load plot Setup from file, see section <b>Save Plot Setup</b>	
-h, --help	show help message for command line options	
--verbose	generate verbose log messages	
<i>com-file</i>	LS-OPT command file By default, the viewer loads the LS-OPT database called <i>lsopt_db</i>	

**Table 18-4: Command line options**

### 18.1.8. Iteration Panel

Except for the Optimization History plot which displays the iteration history, all plots allow specifications for the iteration data to be shown. The available options depend on the plot type (see Figure 18-11).



**Figure 18-11: Iteration Panel- only current iteration (left), all previous/ all iterations (middle), iteration range and step size (right)**

A slider is available to select the current iteration to be plotted. Some plots allow plotting all previous iterations or all iterations, and the Scatter- and Tradeoff plots also allow the specification of a range and a step size, e.g. the selection in the right iteration panel in

Figure 18-11 plots iterations 2,4,6,8 and 10.

### 18.1.9. Ranges

Most plots allow specifications of the ranges for all plotted entities, Figure 18-12.

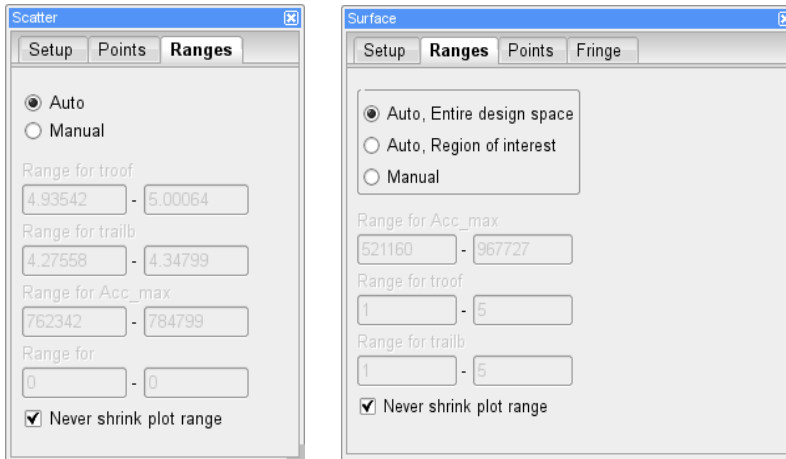
The default is **Auto**. In this case, the range is set to the minimal and maximal value to plot.

For surface plots, there are two options for **Auto** range selection. **Auto, Entire design space** plots the surface across the full design space, **Auto, region of interest** uses only the subregion of the selected iteration.

If **never shrink plot range** is selected, the ranges of the previous plot are considered and they are enlarged if the new plot has values outside that range, see the Neural Net plot displayed in Figure 18-26. This option is ignored if entities change.

**Manual** range selection allows the user to specify lower and upper bounds for each plotted entity.





*Figure 18-12: Ranges selections*

## 18.2. Visualization of Simulation Results

### 18.2.1. Correlation Matrix

The correlation matrix displays 2D scatter plots, histograms and the linear correlation coefficients calculated from the simulation results of the selected load case for the selected variables, dependents, responses and composites, Figure 18-13.

Moving the mouse on a scatter plot displays its ranges and marks the respective correlation coefficient with a yellow border, and vice versa. Row and column entities may be selected separately, hence it's also possible to display e.g. only correlation coefficients, Figure 18-14.

By double-clicking on a scatter plot or histogram, the respective plot may be reached, see Section 18.2.2 or Section 18.2.5, respectively.

The correlation coefficients are color-coded from blue to red. Blue indicates a strong negative correlation, red a strong positive correlation, whereas grey indicates almost no correlation.

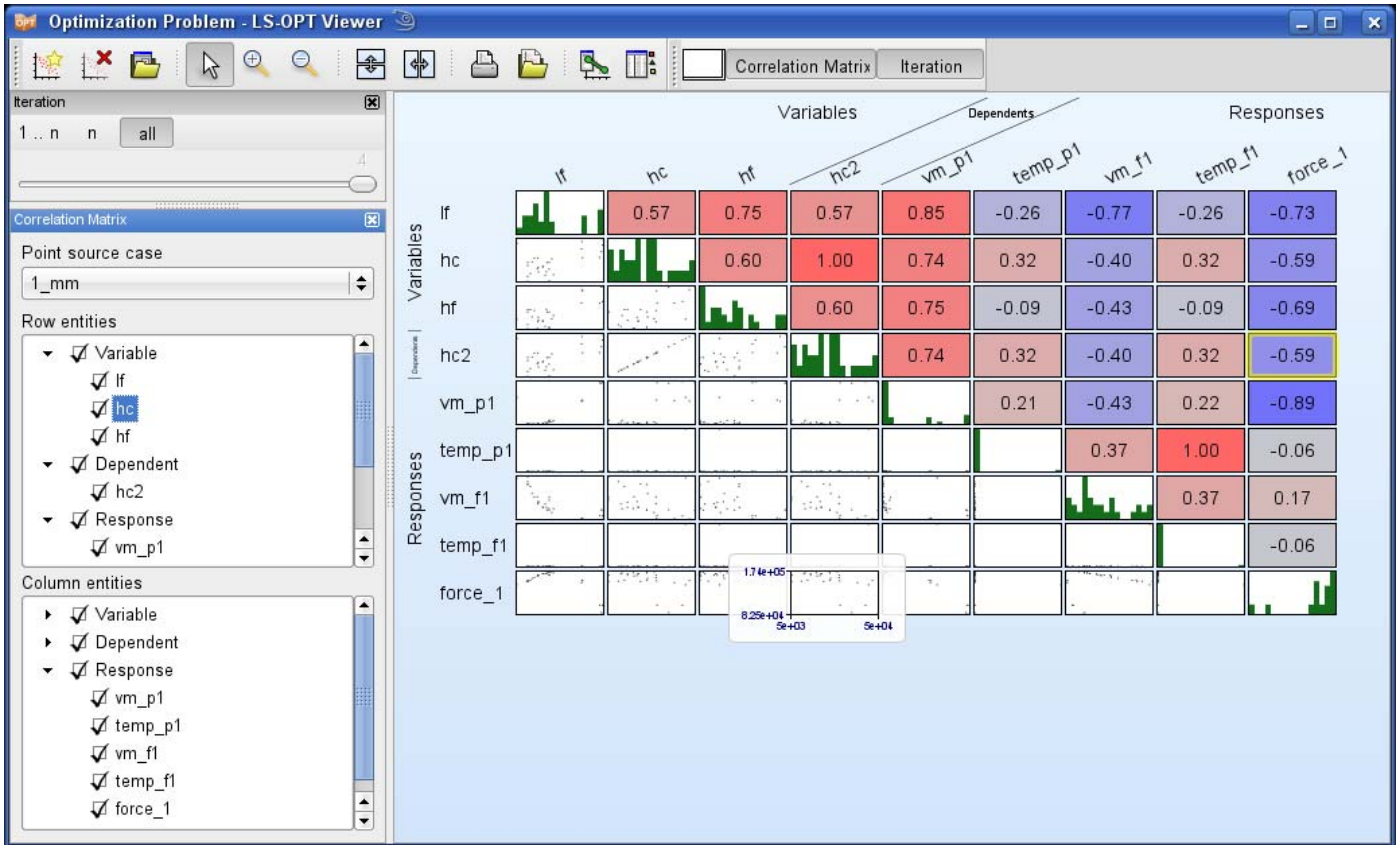


Figure 18-13: Correlation matrix with scatter plots, histograms and linear correlation coefficient

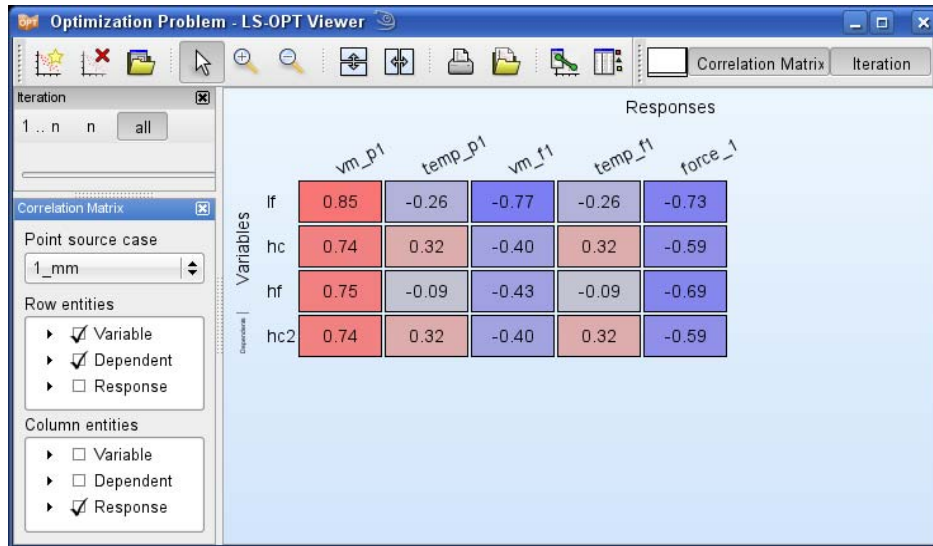


Figure 18-14: Correlation matrix, only correlation coefficients

### 18.2.2. Scatter Plot

The results of all the simulated points for the selected iterations appear as dots on the scatter plots. This feature allows the three-dimensional plotting of any three entities. A fourth entity may be displayed using the color of the points. Other coloring options are explained below. 2D plots can be obtained by selecting **No entity** for the z axis. For 3D plots, the image rotation is performed by holding down the Ctrl key while moving the mouse (same as LS-PREPOST).

To be able to view the results of composite functions spanning two or more disciplines or cases, the duplicate sampling method (Section 5.2) must be selected before starting an analysis. This also implies that the number of variables must be the same for all the disciplines involved and yields coincident experimental designs. (This can be accomplished by selecting the *duplicate* option in the *Sampling* tab when inputting the data in the GUI).

#### Color Entities – 3D Plots

Selection	Description
<i>Feasibility</i>	Feasible points are shown in green, infeasible points in red
<i>Previous b/w</i>	The points for the current iteration are shown in green (feasible) or red (infeasible). Previous points as light grey (feasible) or dark grey (infeasible)
<i>Iterations</i>	The iteration sequence is shown using a color progression from blue through red.
<i>Neutral</i>	All points are shown in blue

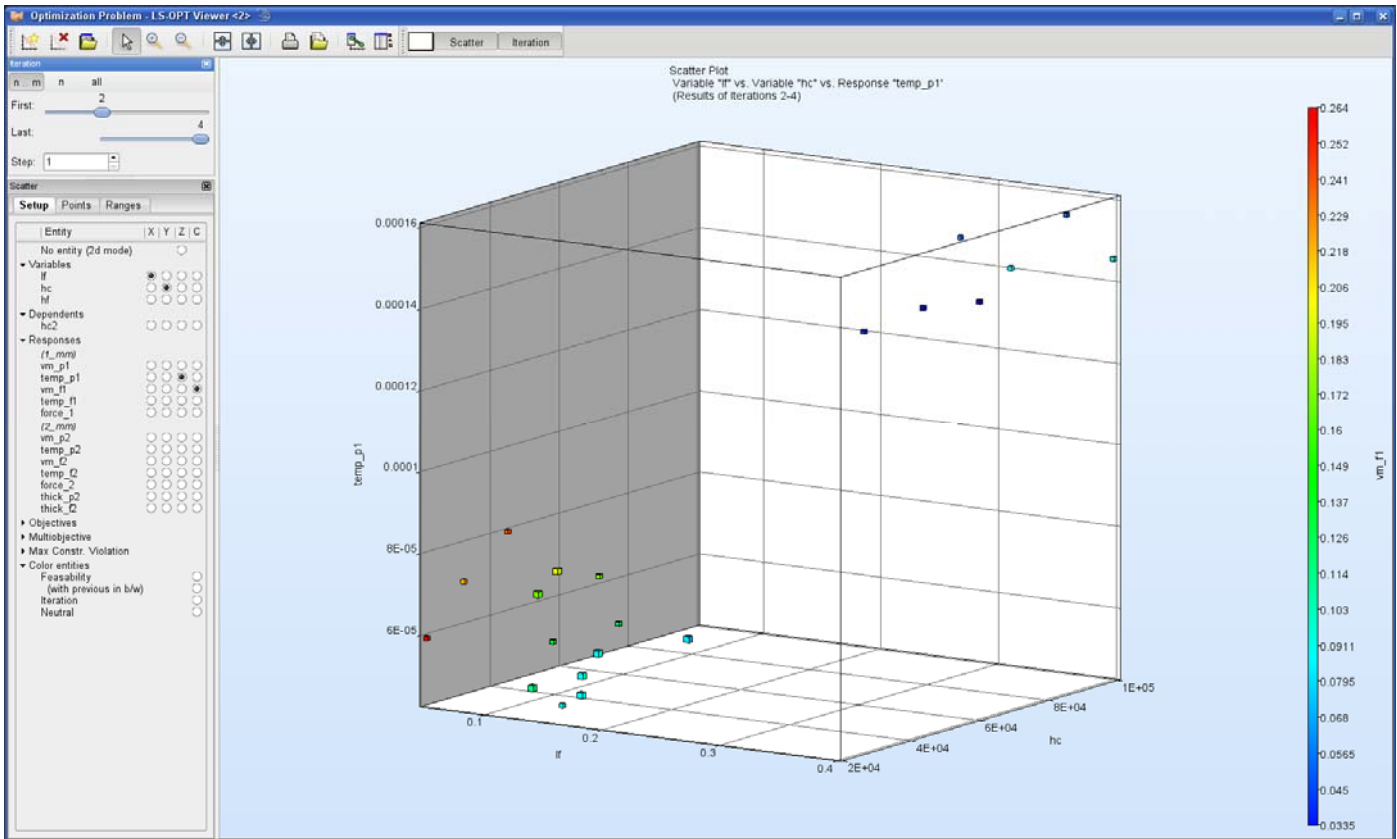


Figure 18-15: Scatter plot in View panel in LS-OPTui. The 4<sup>th</sup> dimension is represented by point color.

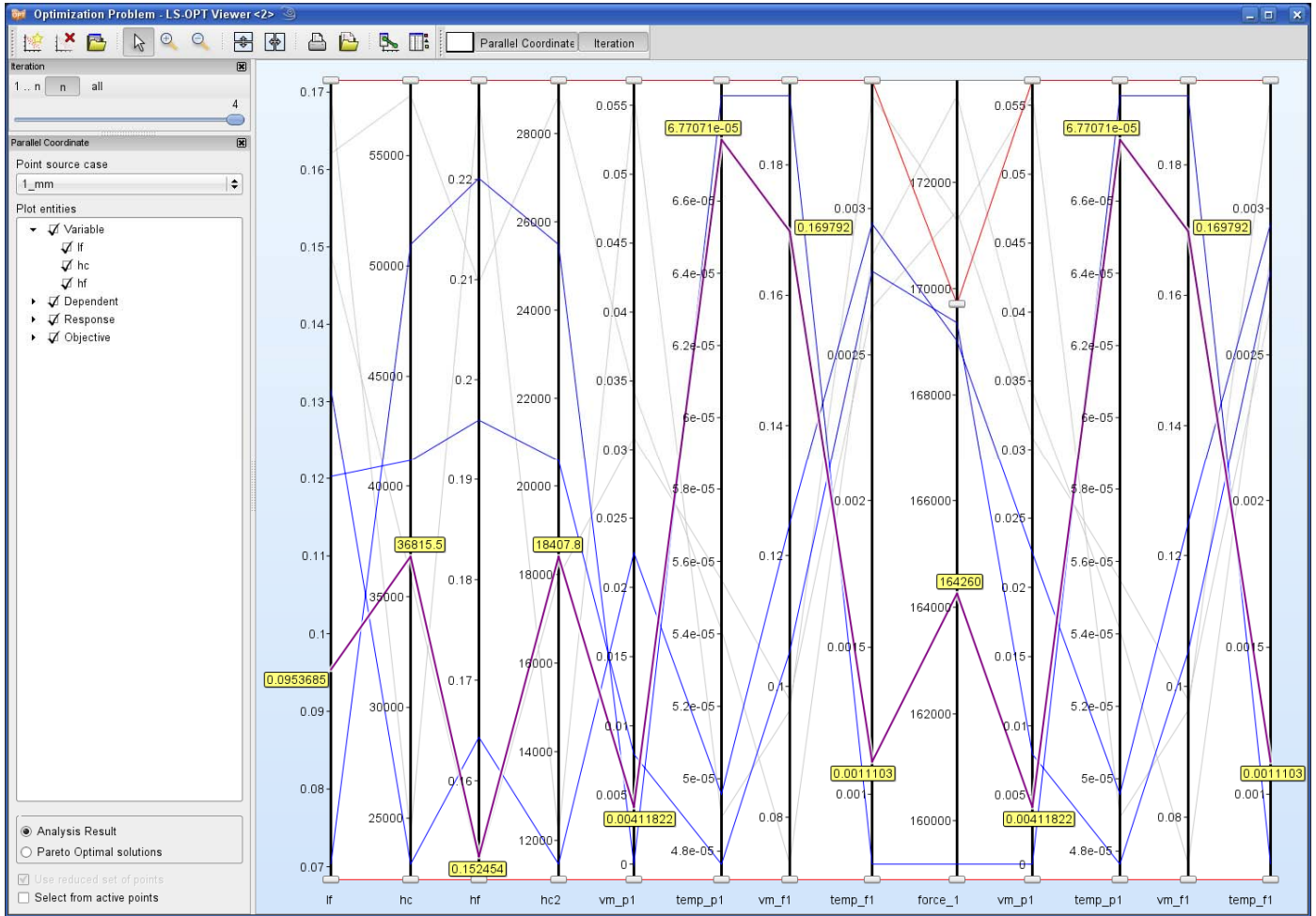
### Points Options

Selection	Description
<i>Analysis Results</i>	Plot simulation results (Default for the Scatter Plot)
<i>Pareto Optimal Solutions</i>	Plot Pareto optimal solutions (Default for the Tradeoff Plot, Section 18.5.1)
<i>Use reduced set of points</i>	Only active for Pareto optimal solutions, plots 100 uniformly distributed points selected from the Pareto optimal solutions

### 18.2.3. Parallel Coordinate Plot

In contrast to the Scatter Plot, the number of dimensions that can be visualized using the Parallel Coordinate Plot is not restricted. Each dimension is visualized on a vertical axis and each data point is shown as a poly-line connecting the respective values on the vertical axis, Figure 18-16. The ranges of the entities may be changed using the sliders at the ends of each vertical axis rendering the points outside the ranges unselectable. Points within the selected ranges are colored in blue, while the remaining points are colored in

grey. Selected points are colored in purple, if only a single point is selected, the corresponding value for each entity is displayed in the plot.



**Figure 18-16: Parallel Coordinate Plot with selected point**

### Options

Selection	Description
<i>Analysis Results</i>	Plots simulation results (Default)
<i>Pareto Optimal Solutions</i>	Plots Pareto optimal solutions (Section 18.5.2)
<i>Use reduced set of points</i>	Only active for Pareto optimal solutions; plots 100 points selected from the Pareto optimal solutions
<i>Select from active points</i>	Selects all points that are not outside the constraints set by the handles, see Section 18.1.4. Useful for visualizing this set of points in another plot.

### 18.2.4. History Plot

This plot visualizes history curves based on time data or crossplots obtained from simulations, Figure 18-17. The coloring options are the same as the point coloring options, see 18.2.2. If histories from files are defined in the optimization problem, they can be visualized in addition to the simulation curves, Figure 18-18.

The **Predicted History** option is explained in Section 18.3.5.

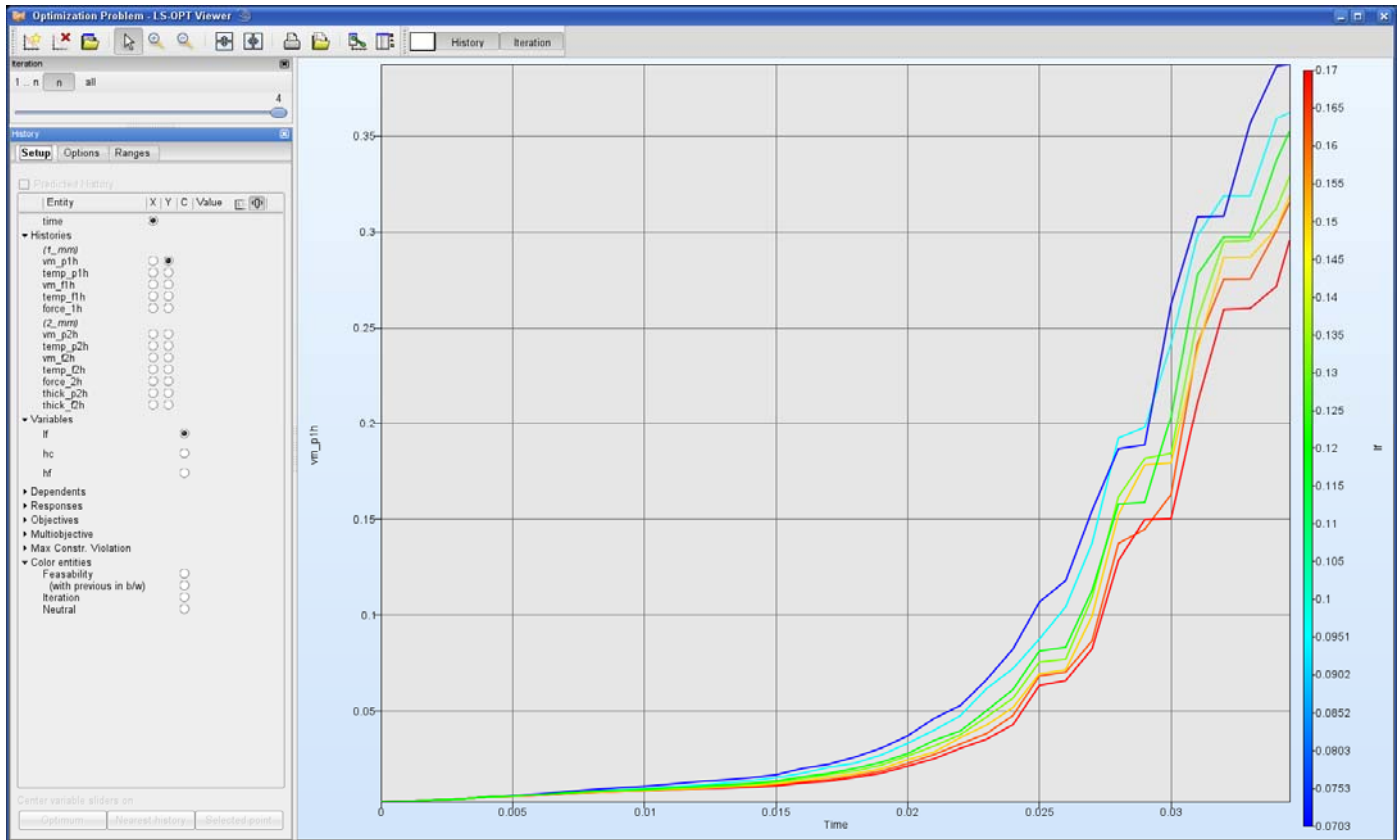
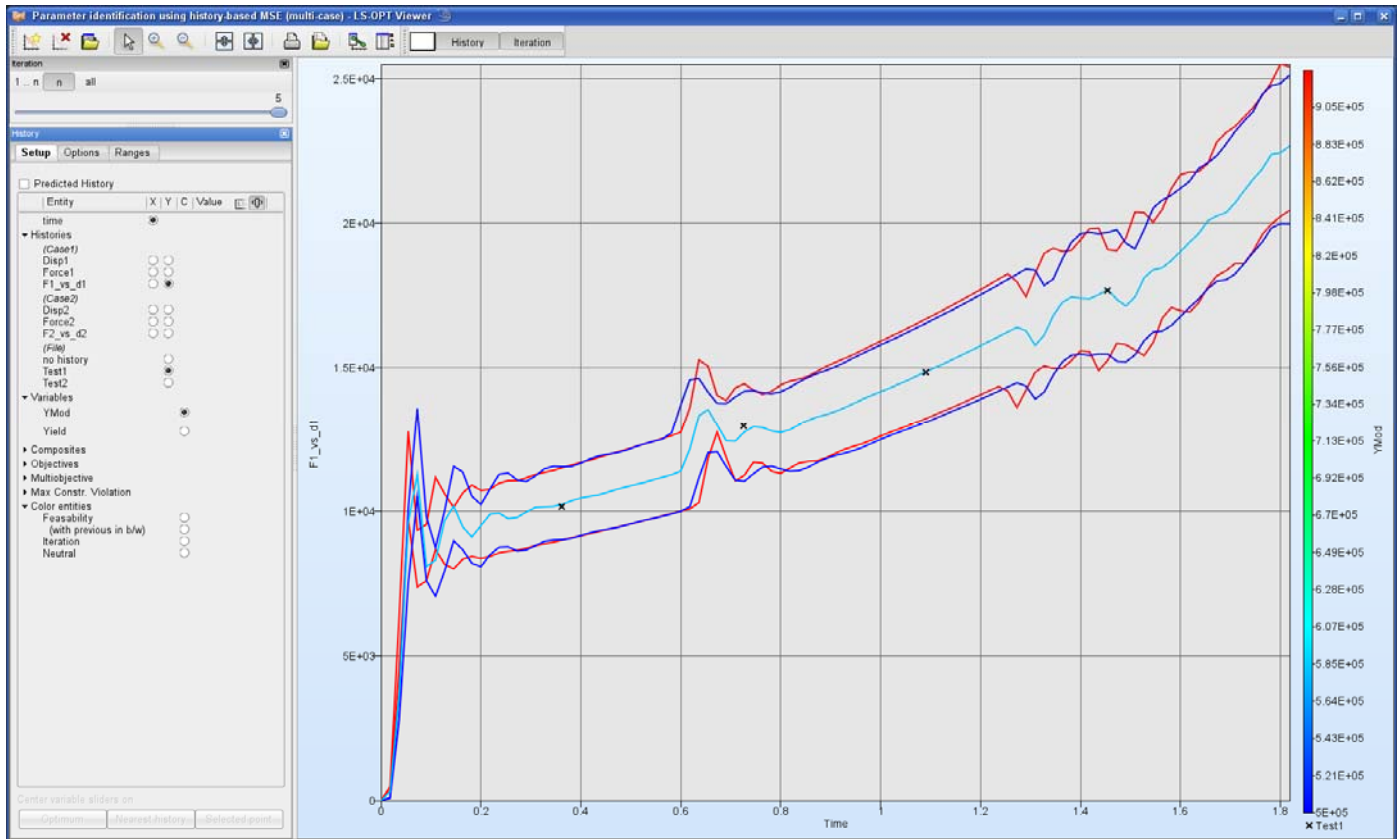


Figure 18-17: History Plot, curves colored by variable

### Options

Selection	Description
<i>Feasible</i>	Plot feasible runs
<i>Infeasible</i>	Plot infeasible runs
<i>Only selected</i>	Plot only selected runs, see 18.1.4., in this case, the selected curves are not highlighted



**Figure 18-18: Histories from simulations colored by variable with target curve (File history)**

### 18.2.5. Statistical Tools

The Statistical Tools option offers three types of plots, Histogram, Summary and Bounds.

The feature enables plotting either (i) the simulation results directly or (ii) using the metamodels together with the statistical distribution of the variables to construct the plots. The simulation results will be read from the ExtendedResults file of the relevant solver. If the use of the metamodels is selected then a Monte Carlo simulation using a Latin Hypercube experimental design and the statistical distributions of the variables will be conducted on the metamodel to obtain the desired values. The user can control the number of points in this Monte Carlo simulation.

If desired, the residuals of the metamodel fit can be added to results of the Monte Carlo simulation as a normal distribution.

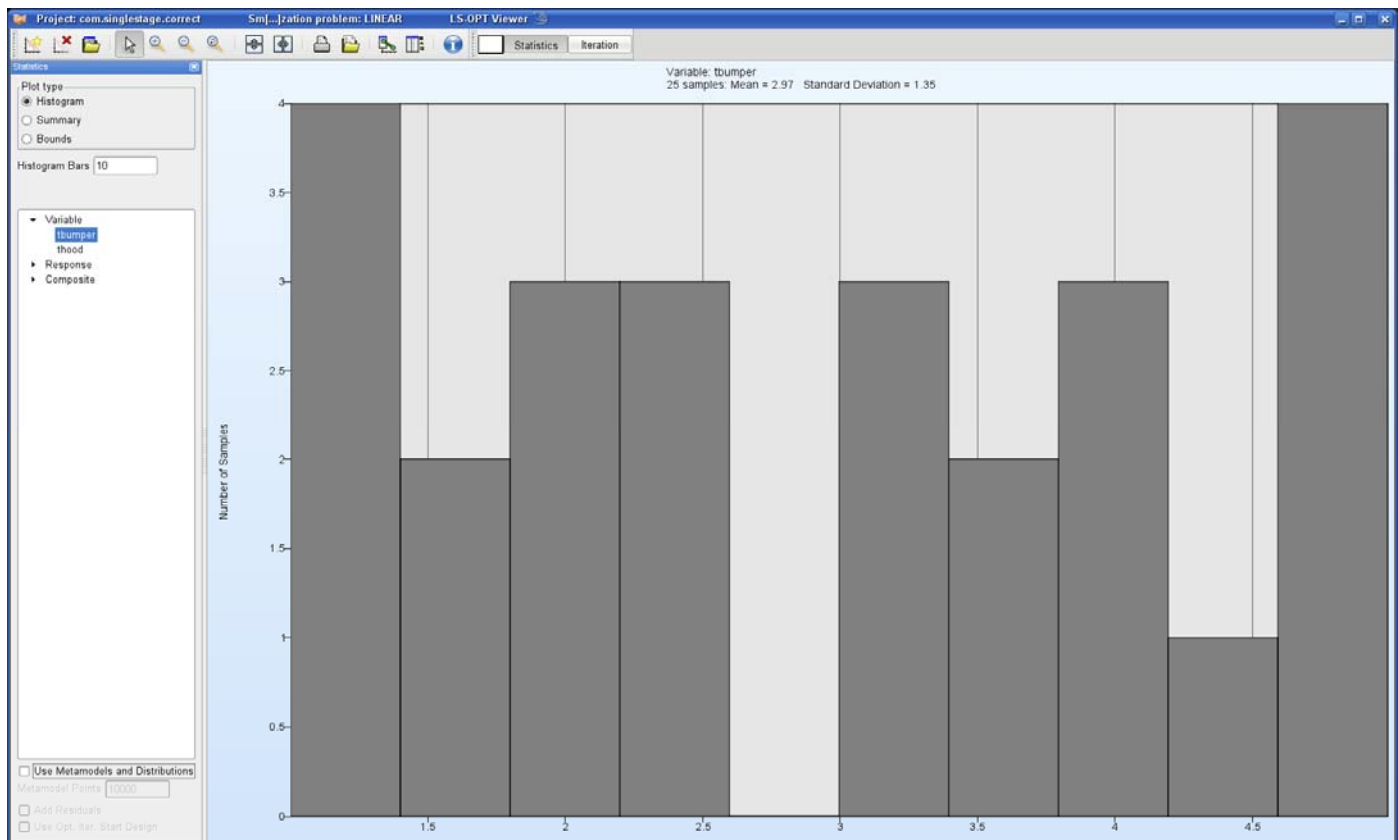
For optimization results, an iteration can be selected, while for probabilistic evaluations the default iteration, iteration 1, will automatically be selected.



## Histogram

Histograms of the variables, dependents, responses, and composites are available. The number of histogram bars may be specified by the user.

The histogram panel is shown in Figure 18-19.

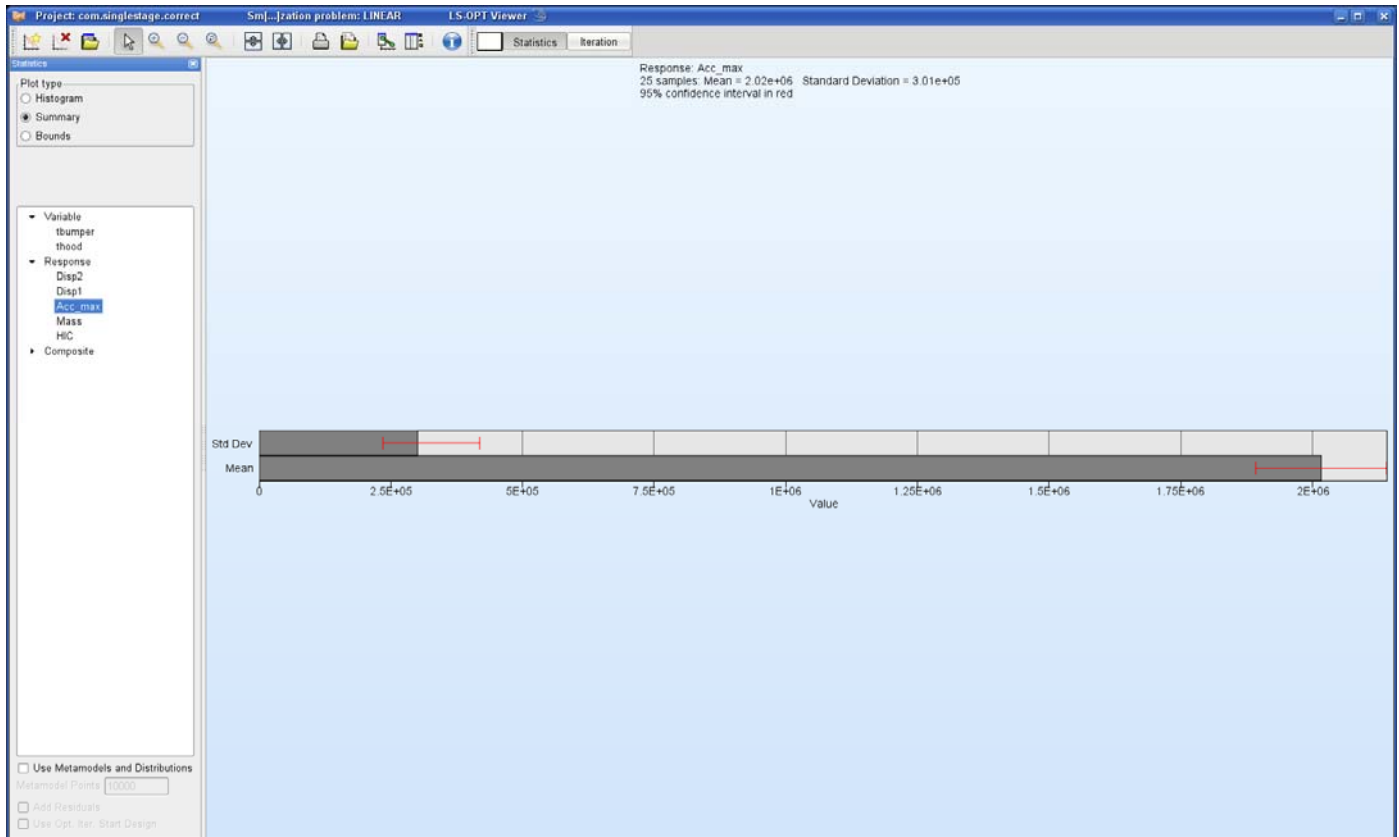


*Figure 18-19: Histogram constructed from simulation results*

## Summary

Here, the standard deviation and the mean value for the selected variable, dependent, response or composite is visualized with the 95% confidence interval in red, Figure 18-20.

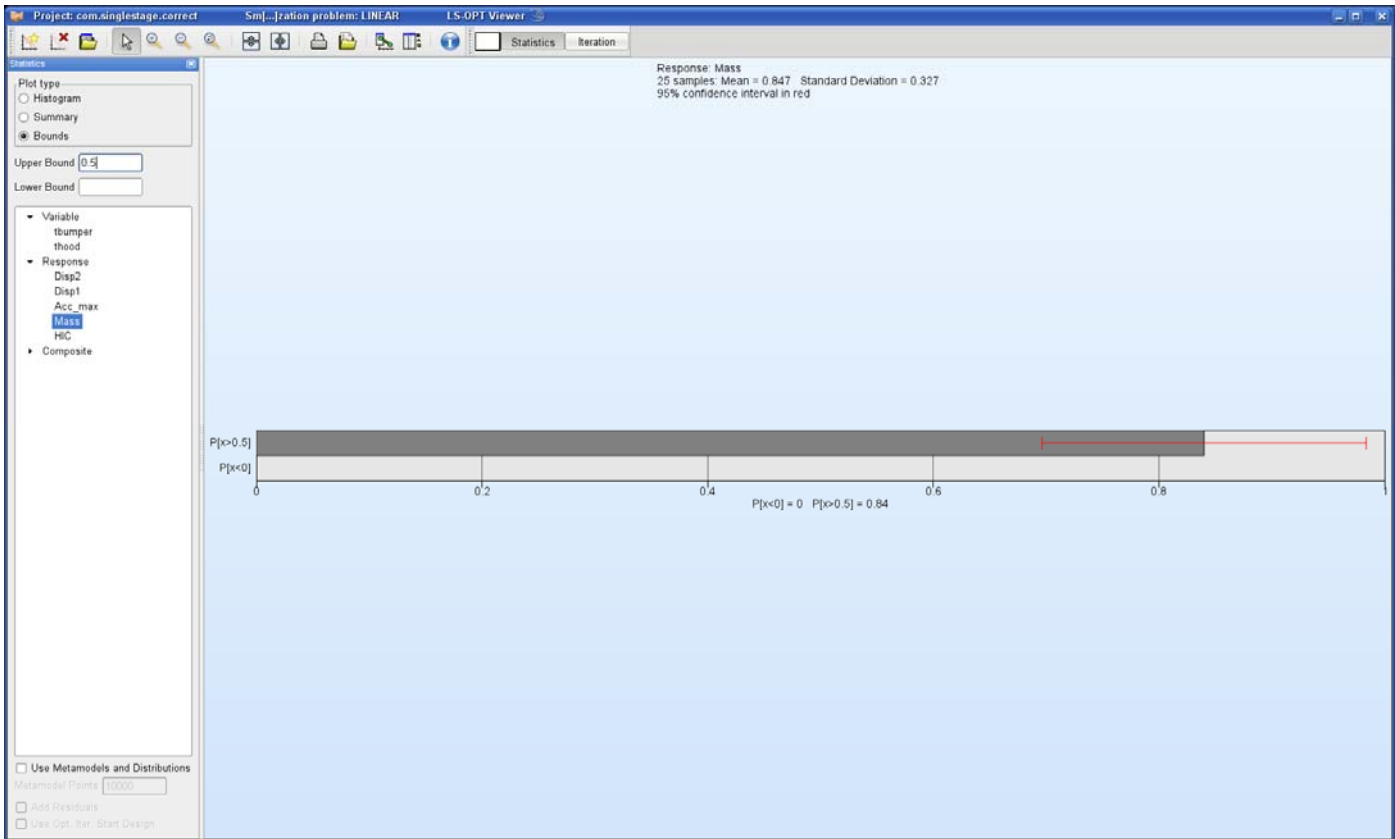




**Figure 18-20:** Standard deviation and mean value of selected response constructed from simulation results

## Bounds

The user may specify lower and upper bounds, respectively, for the selected variable, dependent, response or composite. The probabilities that the entity exceeds the bounds are visualized with 95% confidence interval in red, Figure 18-21.



**Figure 18-21:** Probability of Mass > 0.5 with 95% confidence interval in red constructed from simulation results

## Histogram Options

Selection	Description
<i>Use Metamodels and Distributions</i>	Use metamodels and statistical distribution of the input variables to construct statistics
<i>Metamodel Points</i>	Number of points used for Monte Carlo Simulation on the metamodel to construct statistics
<i>Add Residuals</i>	Add residuals of the metamodel fit (“noise”) to the results of the Monte Carlo simulation as a normal distribution
<i>Use Opt. Iter. Start Design</i>	

### 18.2.6. Correlation Bars

Both the covariance and the coefficient of correlation of the responses and composites with respect to the design variables can be displayed, Figure 18-22.

Either the simulated points or the metamodels together with the statistical distribution of the variables can be used. If a metamodel is used then a Monte Carlo simulation using a Latin Hypercube experimental design

and the statistical distributions of the variables will be conducted on the metamodel to obtain the desired results. The user can control the number of points in the Monte Carlo simulation.

The plot can be used to estimate the stochastic contribution of an analysis without a metamodel.

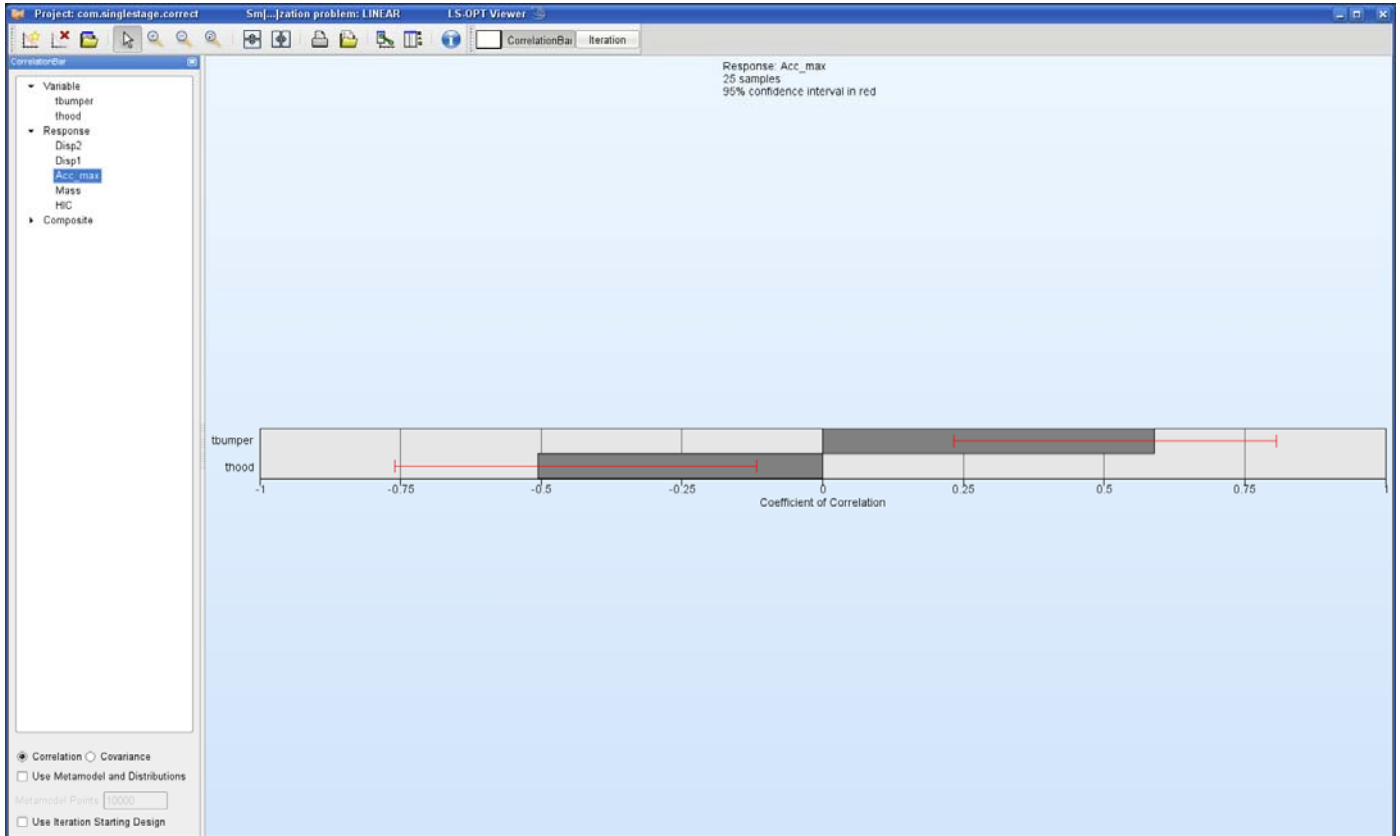


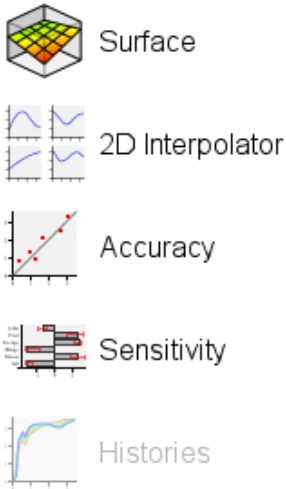
Figure 18-22: Coefficient of Correlation plot with 95% confidence interval in red

### Options

Selection	Description
<i>Correlation</i>	Plot correlation coefficient
<i>Covariance</i>	Plot covariance
<i>Use Metamodels and Distributions</i>	Use metamodels and statistical distribution of variables to construct statistics
<i>Metamodel Points</i>	Number of points used for Monte Carlo Simulation on the metamodel to construct statistics
<i>Use Opt. Iter. Start Design</i>	

## 18.3. Visualization of Metamodel Results

## Metamodel



**Figure 23: Metamodel options**

### 18.3.1. Surface Plot

Two- or three-dimensional cross-sections of the metamodel surfaces and simulation points can be plotted and viewed from arbitrary angles. The image rotation is performed by holding down the Ctrl key while moving the mouse (same as LS-PREPOST). The XY, XZ and YZ buttons at the bottom of the panel rotate the plot to the respective coordinate plane.

The following options are available:

#### Setup

The selection of one or two variables and the response or composite function is done here. The sliders allow changing the variable values for unselected variables (variables not plotted). The slider for the active variables can be activated by selecting the “Predicted Value” option.

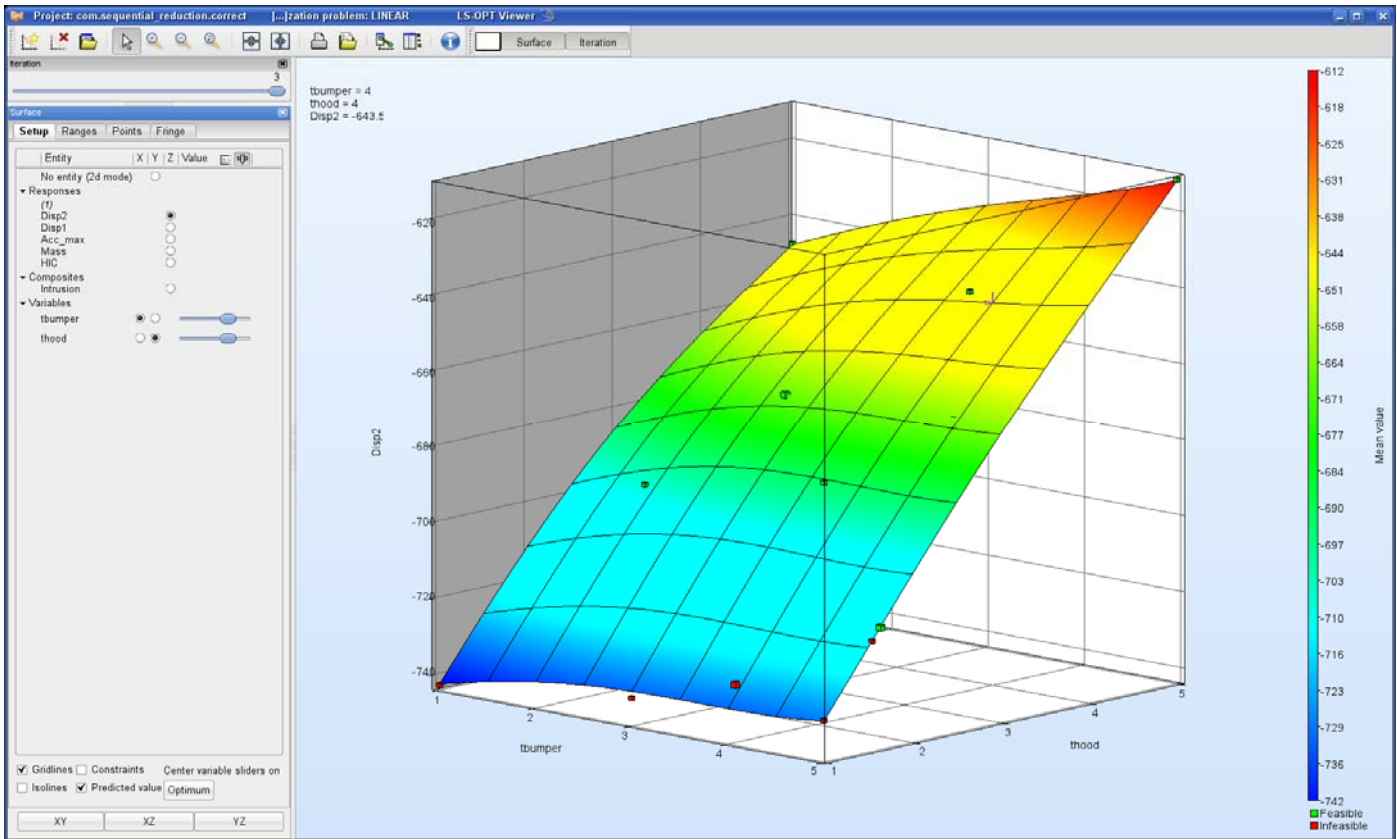
Selection	Description
<i>Gridlines</i>	Gridlines are displayed on the surface, Figure 18-24
<i>Isolines</i>	Isolines are displayed on the surface, Figure 18-25
<i>Constraints</i>	Constraints are displayed on the surface, Figure 18-27. Feasible regions are in green, the shade of red shows the degree of infeasibility (number of violated constraints), the colored lines in 3D and the + marks in 2D, respectively show the location where the constraints are exactly met.
<i>Predicted value</i>	The predicted value for the selected variable values is displayed on the surface, the variable and response values are displayed in the top left corner, Figure 18-24
<i>Center variable sliders on Optimum</i>	Variable sliders are set to optimal values of selected iteration

**Point plotting options**

Selection	Description
<i>Feasible</i>	Show feasible runs only
<i>Infeasible</i>	Show infeasible runs only
<i>Predicted Optimum</i>	Show predicted optimum
<i>Computed Optimum</i>	Show computed optimum
<i>Failed runs on surface</i>	Failed runs such as error terminations are projected to the surface in grey
<i>Points only</i>	Show only points without surface
<i>Project points to surface</i>	The points are projected on the surface to improve visibility. Future versions will have a transparency option.
<i>Show Residuals</i>	Shows a black vertical line connecting the computed and predicted values.

**Point status**

Selection	Description
<i>Feasibility</i>	Feasible points are shown in green, infeasible points in red
<i>Previous b/w</i>	The points for the current iteration are shown in green (feasible) or red (infeasible). Previous points as light grey (feasible) or dark grey (infeasible)
<i>Iterations</i>	The iteration sequence is shown using a color progression from blue through red. See Figure 18-25.
<i>Optimum runs</i>	Optimal points are shown in green/red and all other points in white.



*Figure 18-24: Metamodel plot showing feasible (green) and infeasible (red) points. The predicted point is shown in violet ( $t\_hood = 4$ ,  $t\_bumper = 4$ ) with the values displayed at the top left.*

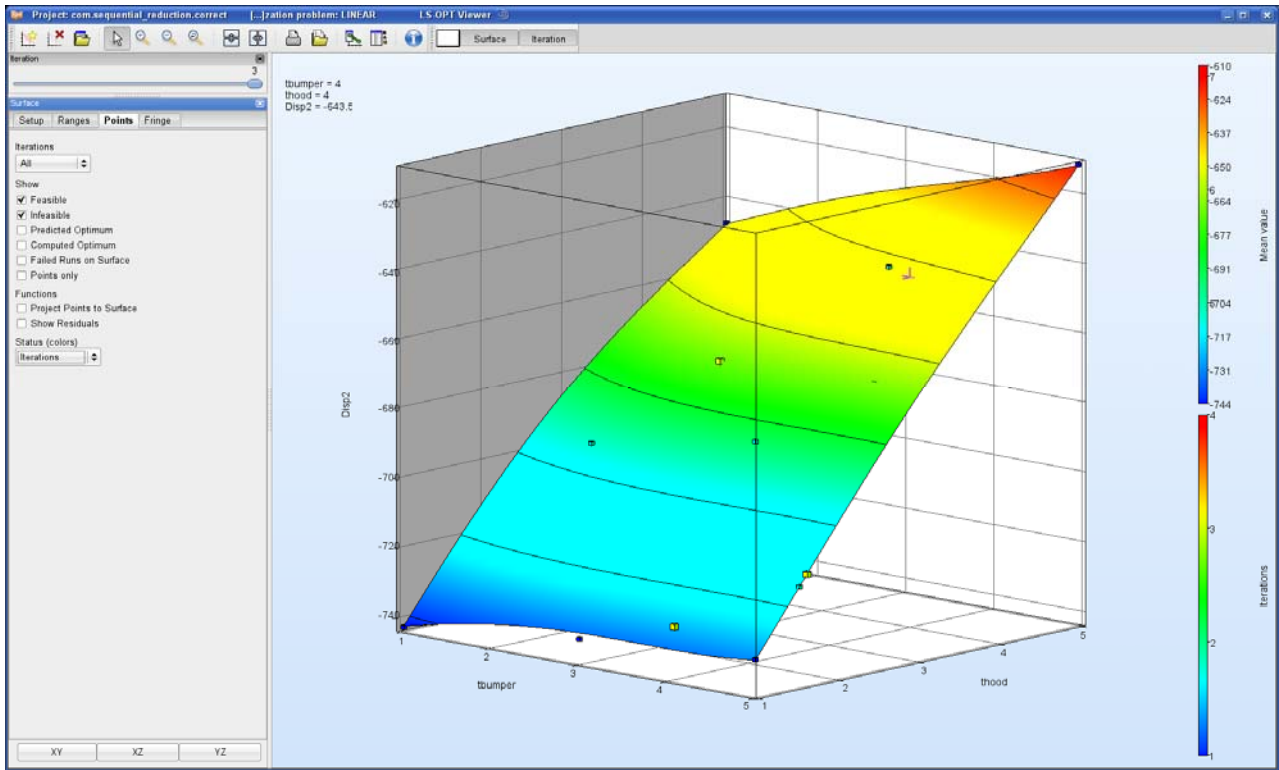


Figure 18-25: Metamodel plot showing point color coding for iteration numbers.

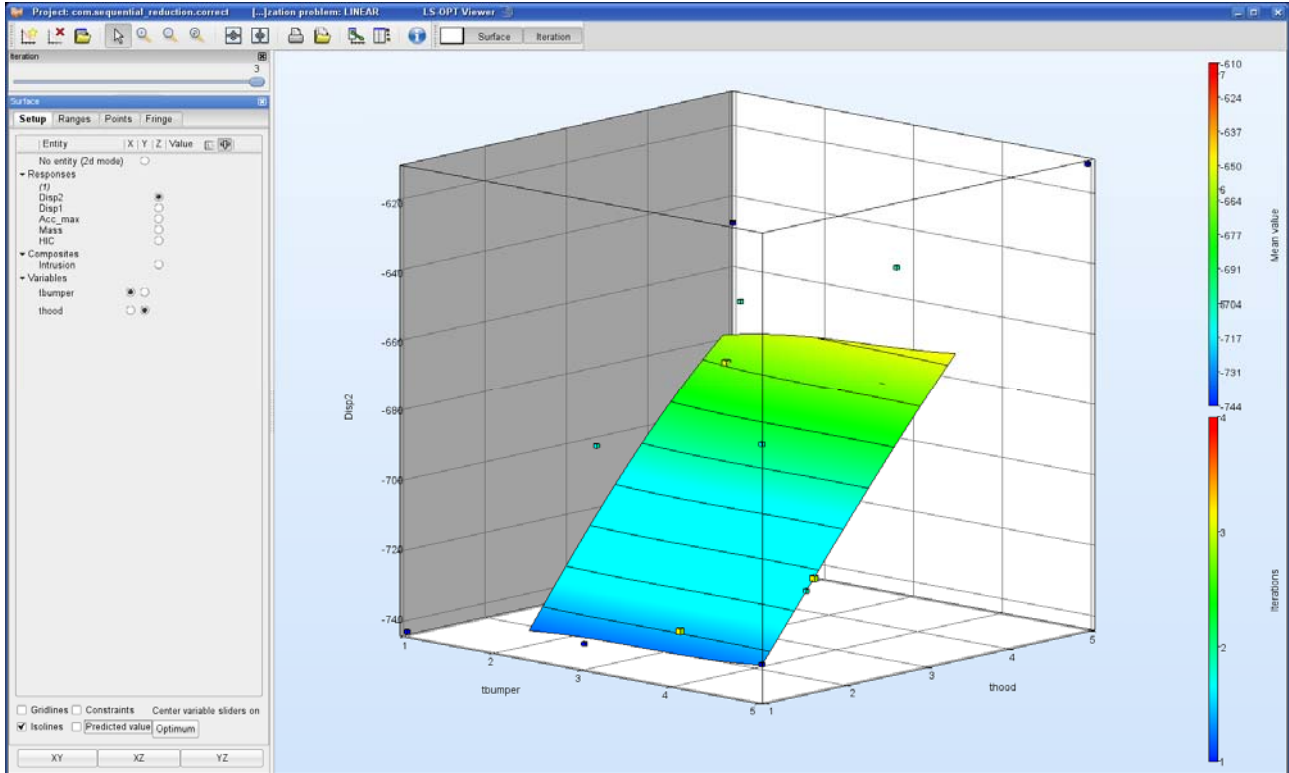
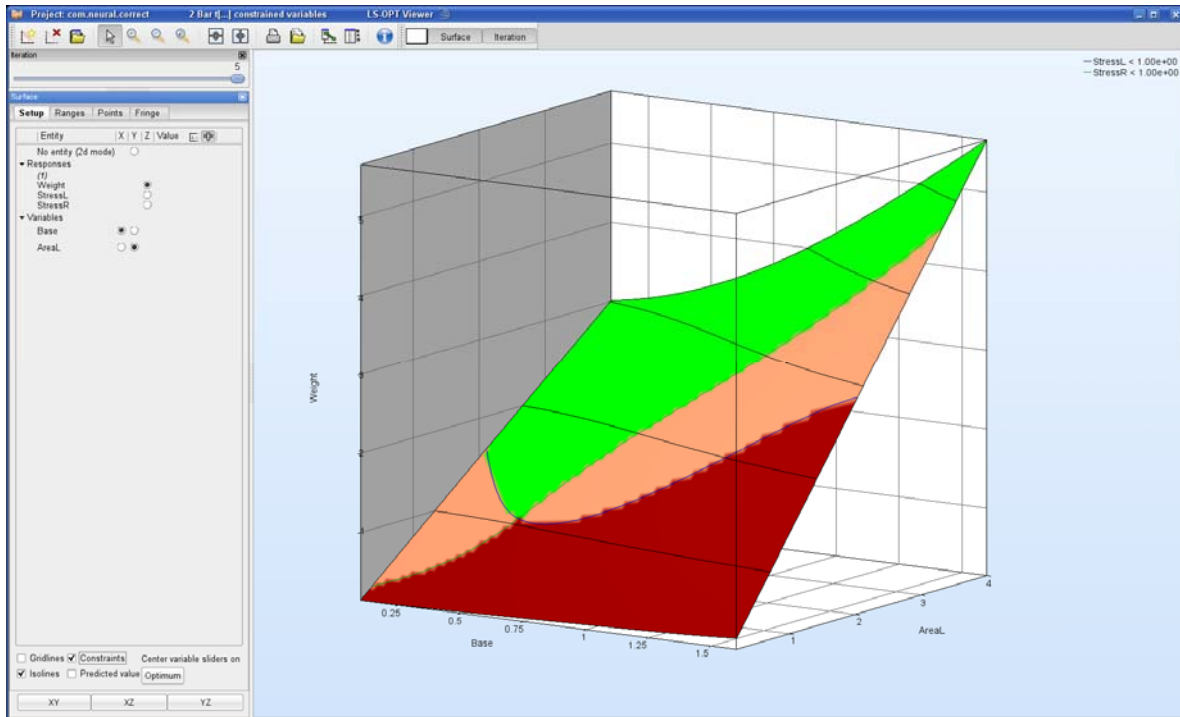
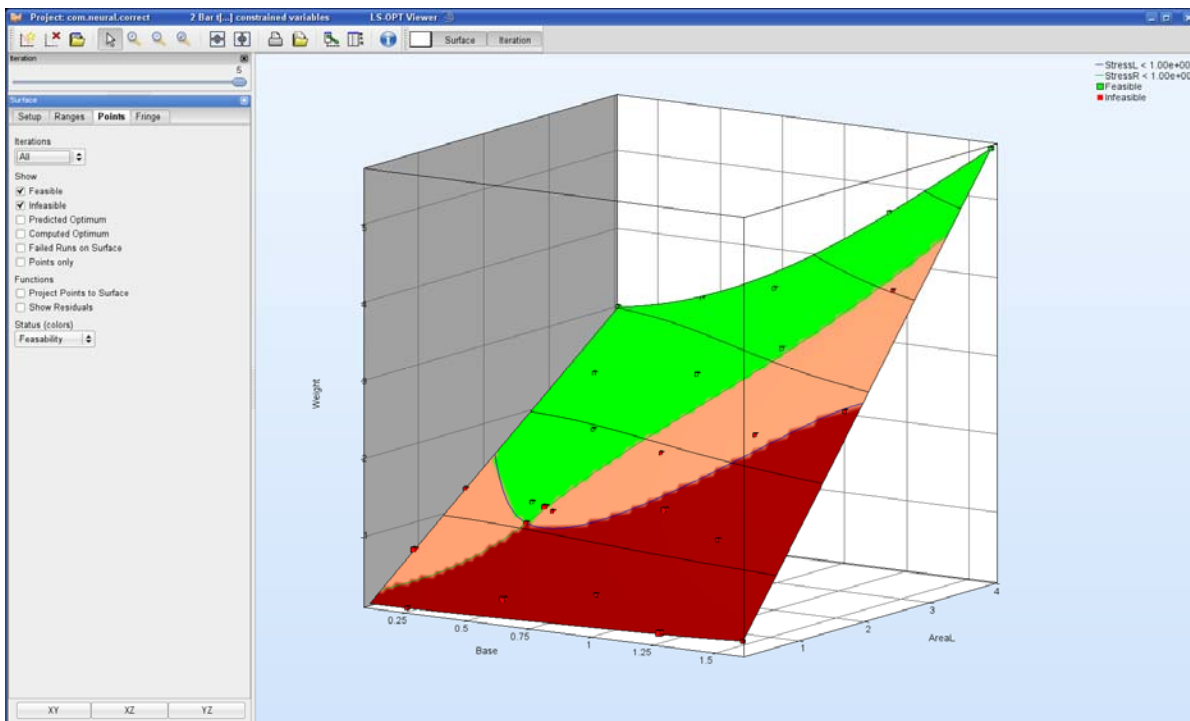


Figure 18-26: Surface plot representing only the region of interest of the fourth iteration.



*Figure 18-27: Plot showing isolines on the objective function as well as constraint contours and feasibility. Feasible regions are in green. Shade of red shows degree of infeasibility (number of violated constraints). Note the legend describing constraints at the top right.*



*Figure 18-28: Plot showing isolines and points opposite the “Points” tab.*



## Fringe plot options for neural nets

The options are function value or standard deviation of the Neural Net committee values. See Figure 18-29.

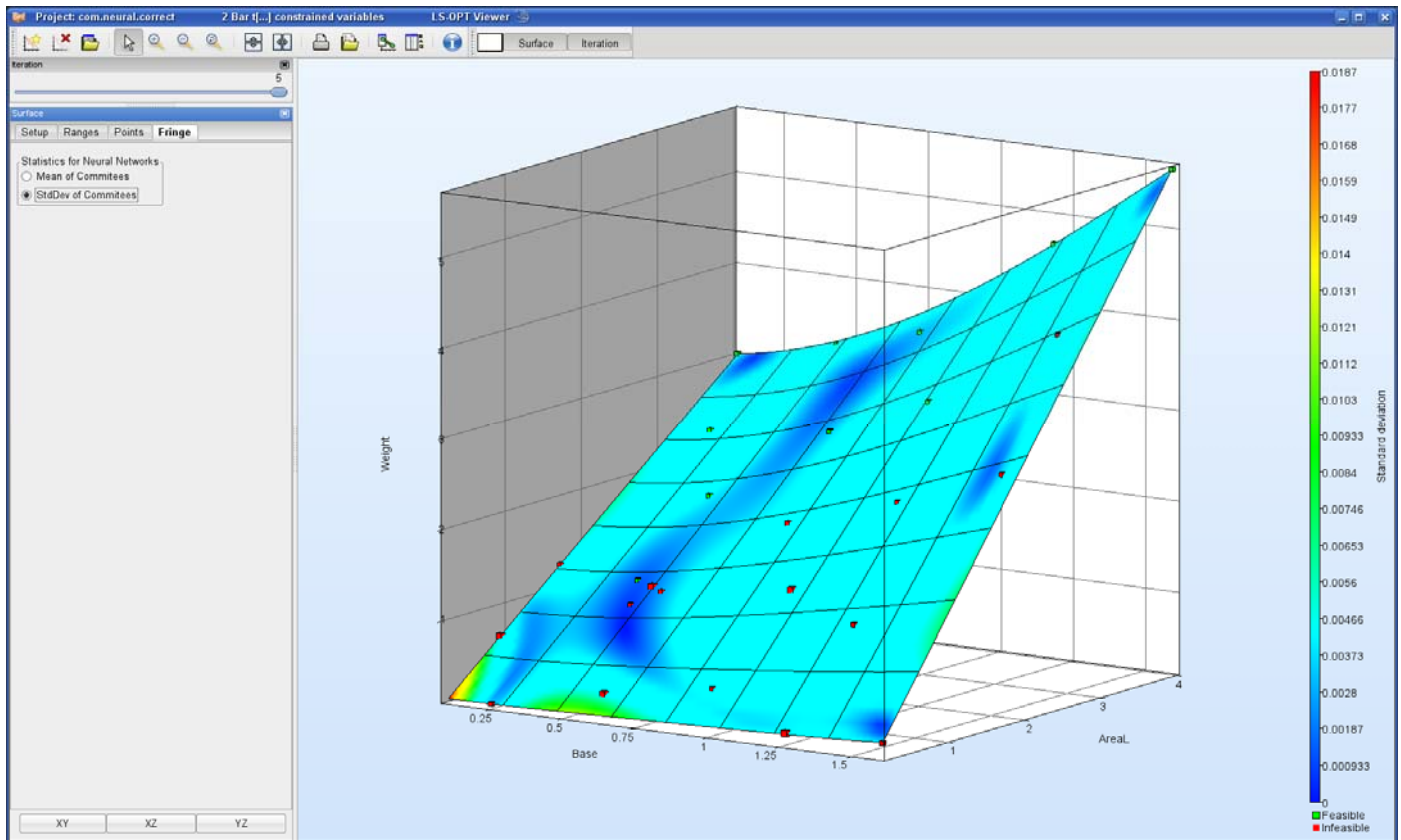


Figure 18-29: Metamodel plot showing standard deviation of the Neural Net committee values.

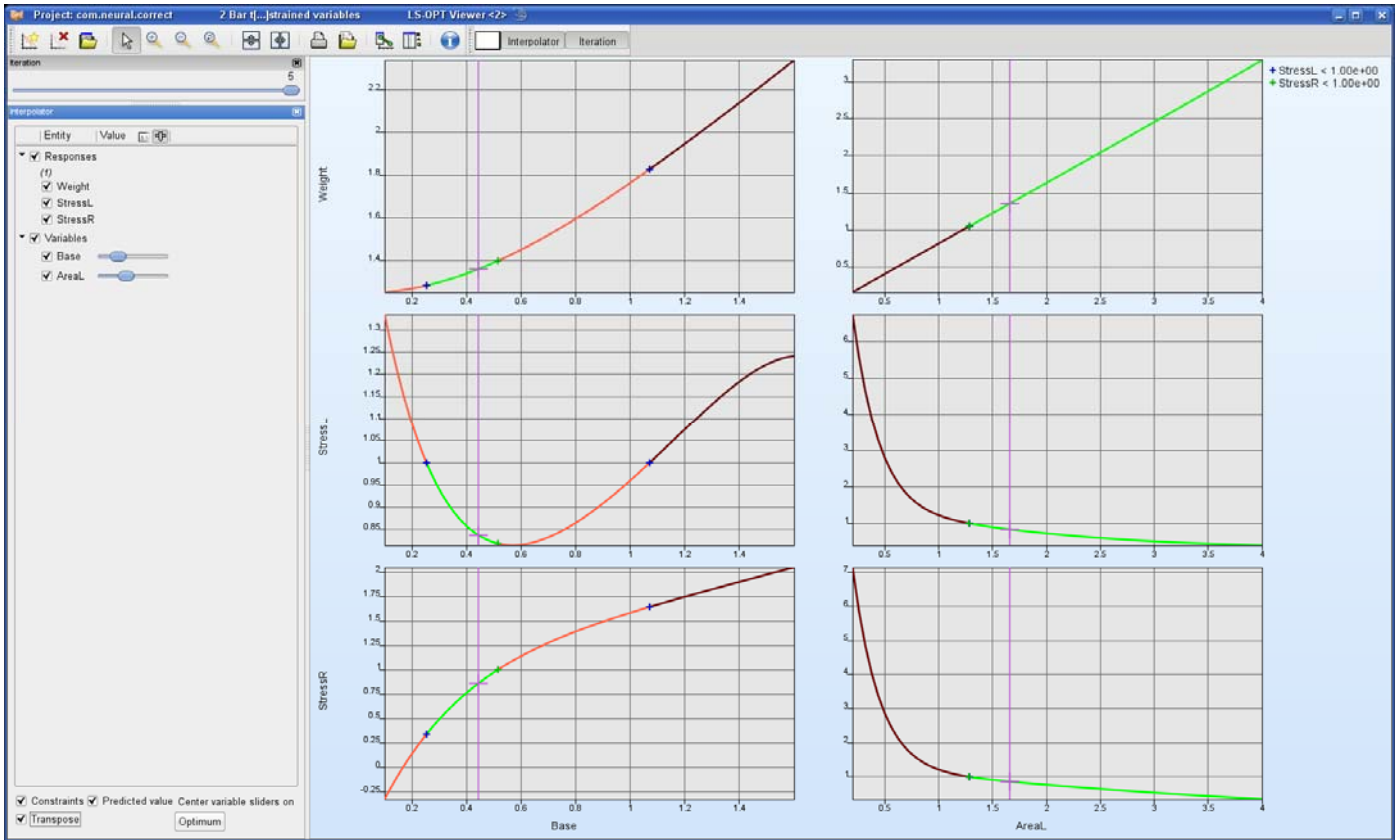
### 18.3.2. 2D Interpolator Plot

The Interpolator plot is a tool to display multiple two-dimensional surface plots. All selected responses and composites are plotted against all selected variables. The default is to display each response against all variables in a row.

#### Options

Selection	Description
<i>Constraints</i>	Constraints are displayed on the surface. Feasible regions are in green, the shade of red shows the degree of infeasibility (number of violated constraints), the colored + marks in 2D show the location where the constraints are exactly

	met.
<i>Predicted value</i>	The predicted value for the selected variable values is displayed on the surface (purple line), the variable and response values are displayed in the panel
<i>Transpose</i>	Allows to display each response against all variables in a column.
<i>Center variable sliders on Optimum</i>	Variable sliders are set to optimal values of selected iteration



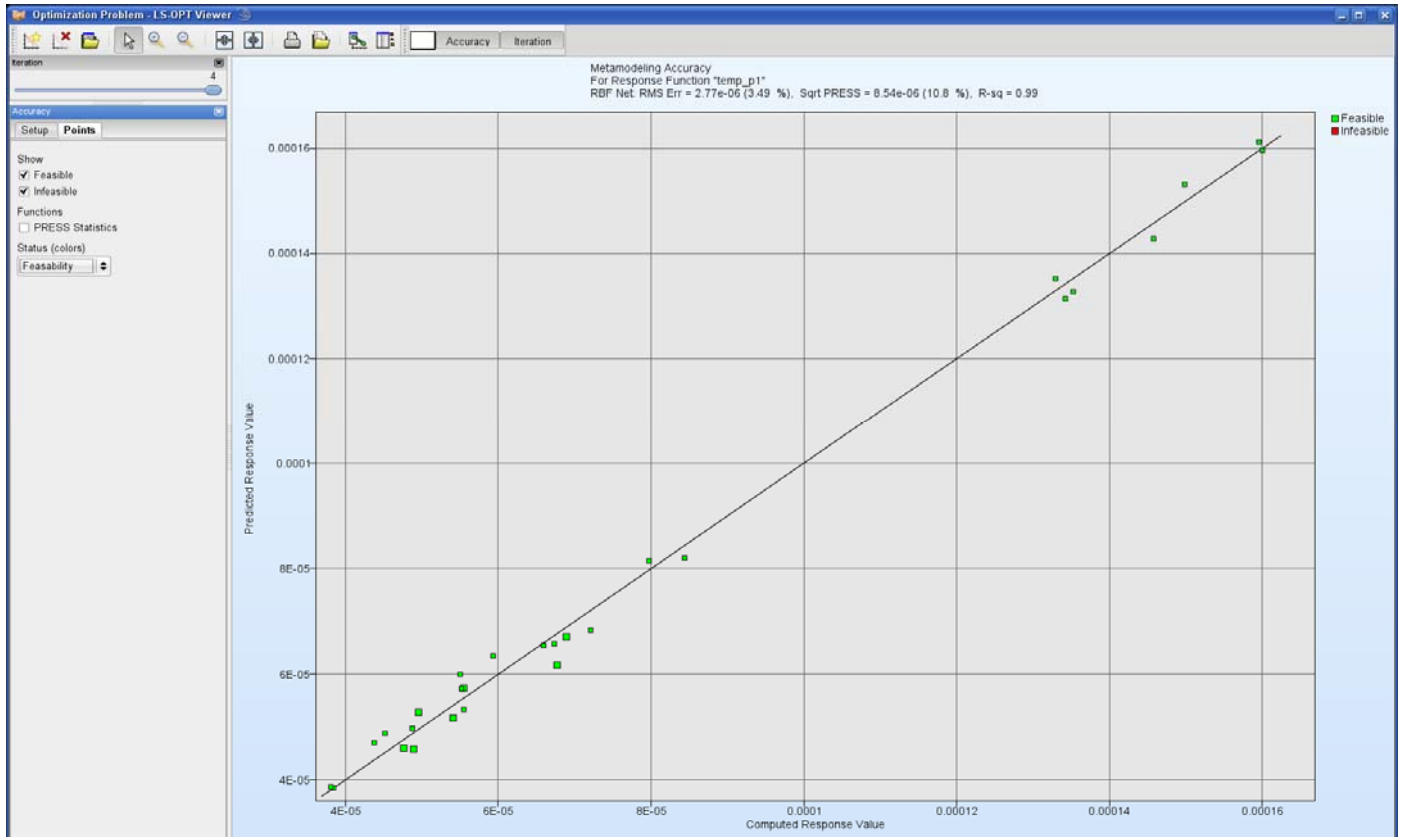
**Figure 18-30: Interpolator Plot with constraints (Feasible regions are in green, shade of red shows degree of infeasibility (number of violated constraints)) and predicted value (purple line)**

### 18.3.3. Accuracy Plot

The accuracy of the metamodel fit for the selected response or composite is illustrated in a Predicted vs. Computed plot, Figure 18-31. The results for the metamodel of each iteration are displayed separately using the slider bar. All points used to approximate the metamodel are displayed, i.e., for linear metamodels, the points of the current iteration are displayed, whereas for all other metamodels, the points of all previous iterations are also visualized, Figure 18-31. The error measures are displayed in the heading.

## Options

Selection	Description
<i>Feasible</i>	Plot feasible runs
<i>Infeasible</i>	Plot infeasible runs
<i>PRESS statistics</i>	PRESS residuals are plotted against computed values
<i>Status (colors)</i>	Coloring options for points, see 18.2.2



**Figure 18-31:** *Computed vs. Predicted plot in View panel in LS-OPTui. The points are color-coded to represent the feasibility. The largest points represent the most recent iteration.*

### 18.3.4. Sensitivities

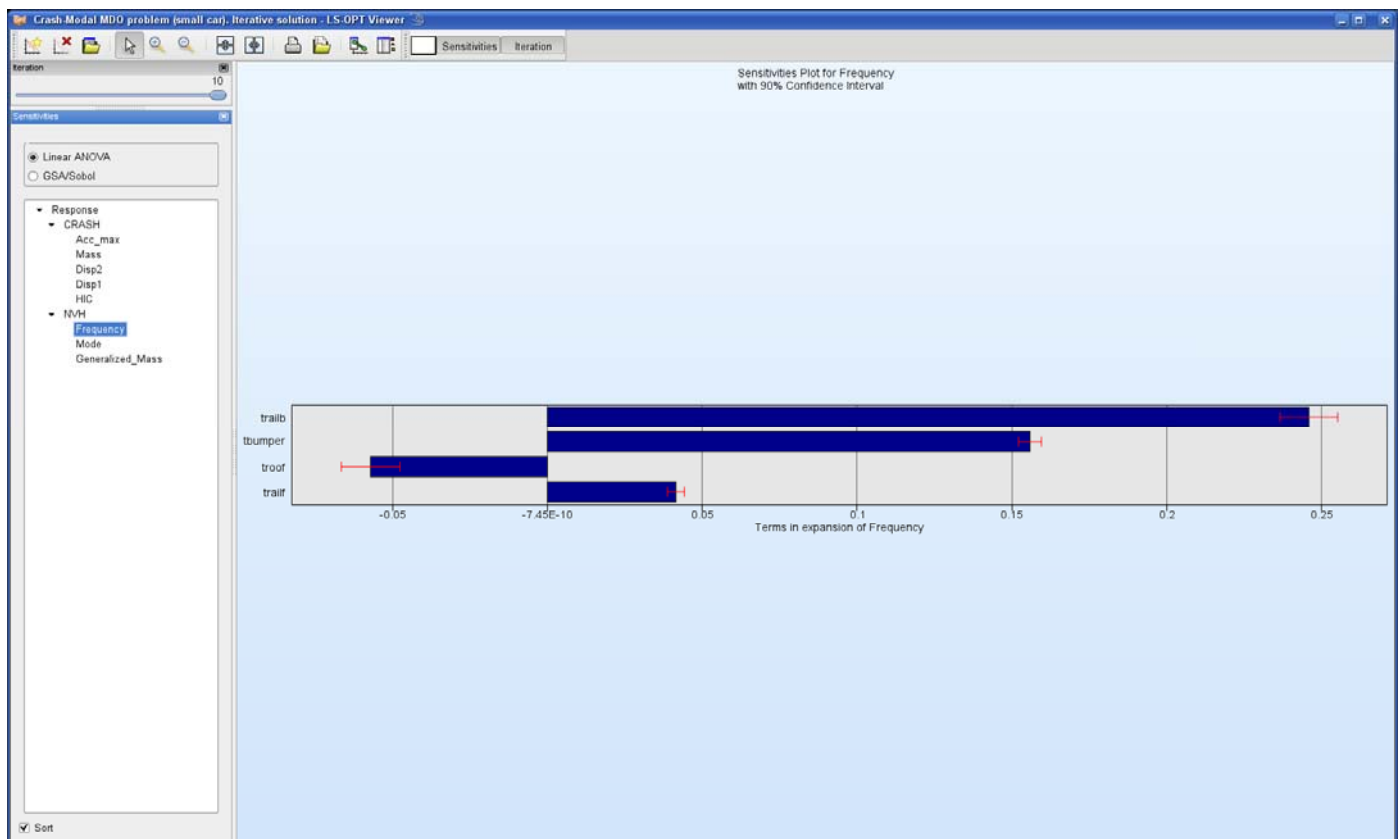
The Sensitivities Plot provides visualization of the results of ANOVA and global sensitivity analysis (GSA) using Sobol's variance-based sensitivity indices.

## Linear ANOVA

The Analysis of Variance (ANOVA) (refer to Section 2.4) of the approximation to the experimental design is automatically performed if a polynomial response surface method is selected. The ANOVA information can be used to screen variables (remove insignificant variables) at the start of or during the optimization process. The ANOVA method, a more sophisticated version of what is sometimes termed ‘Sensitivities’ or ‘DOE’, determines the significance of main and interaction effects through a partial  $F$ -test (equivalent to Student’s  $t$ -test) [1]. This screening is especially useful to reduce the number of design variables for different disciplines (see Sections 5.2 (theory) and 22.6 (example)).

If a probabilistic or an RBDO analysis is being done, then the Stochastic Contribution plots (see Section 18.6.3) are recommended.

The ANOVA results are viewed in bar/tornado chart format, Figure 18-32. The **Sort** option sorts the ANOVA values by relevance, the sorting doesn’t consider the 90% confidence interval.



**Figure 18-32: Linear ANOVA plot in View panel in LS-OPTui, sorted**

## GSA/Sobol

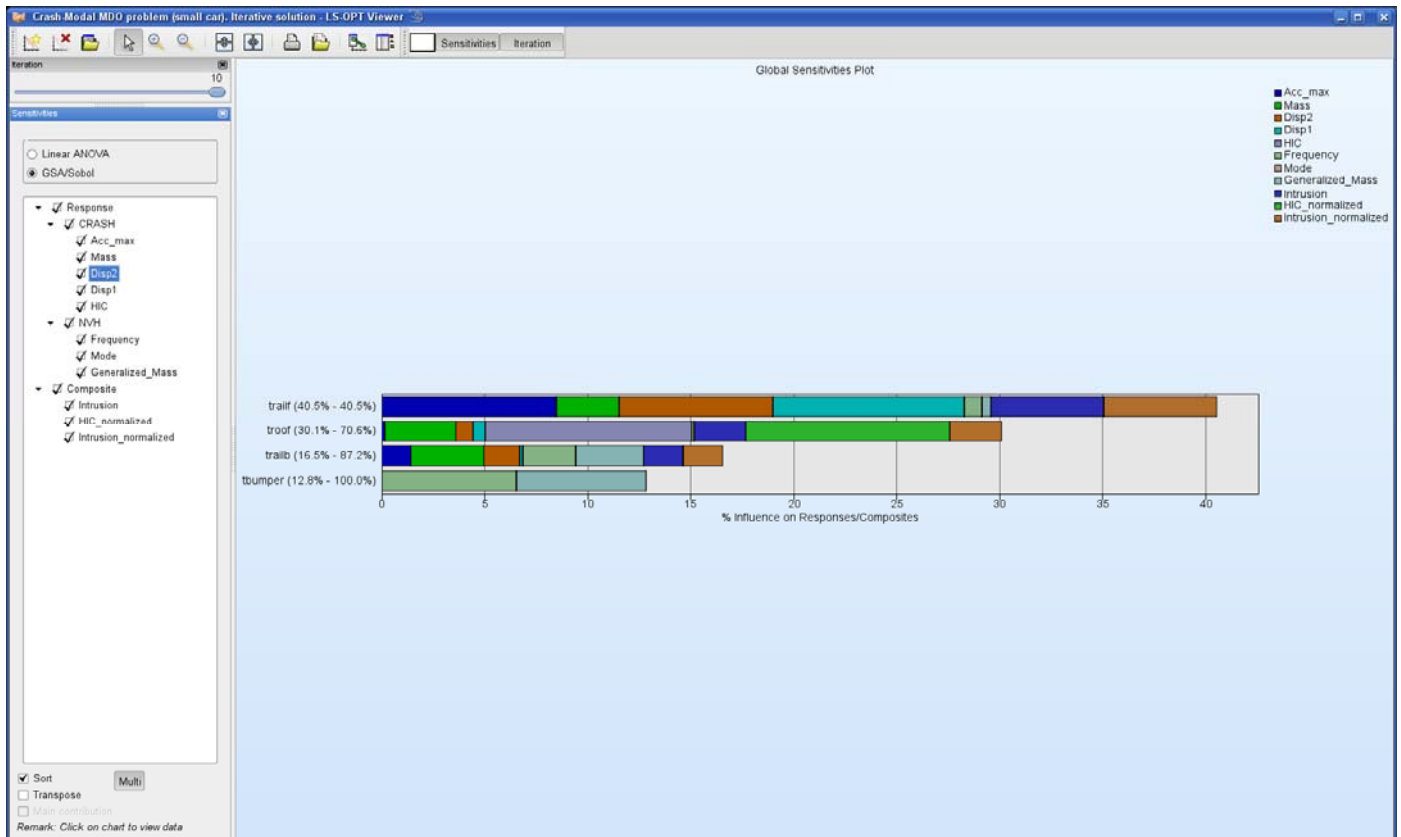
A global sensitivity analysis is only performed if **Compute global Sensitivities** is selected in the Sampling panel of LS-OPTui, see Section 13.2.

Figure 18-33 displays an example of a global sensitivities plot. Each bar represents the contribution of a variable to the variance of the respective response (total sensitivity index). The values are normalized such that the sum of all displayed values is 100%. The values are displayed in the labels. For sorted plots, the cumulative sensitivity indices of all values in descending order are also displayed in the label.

Clicking on the chart displays the respective sensitivity values and variances in the plot.

## Options

Selection	Description
<i>Sort</i>	Sorts data by relevance
<i>Transpose</i>	Sensitivity values are grouped by response/composite
<i>Main contribution</i>	Main contribution is displayed in addition to total contribution
<i>Multi</i>	Allows selection of multiple responses/composites



**Figure 18-33: Sorted global sensitivities of all responses and composites**

### 18.3.5. History Plot

If the **Approximate History** option is set in the Sampling Panel of LS-OPTui, a database that approximates the histories for any design point using metamodels is provided, see Section 14.22. If **Predicted History** is selected, the history evaluated on the metamodel for the selected design point is visualized, Figure 18-35. If the predicted histories are colored by variable, multiple curves are plotted for equidistant values in the range of the selected variable. This visualizes the influence of the selected parameter on the history curve, Figure 18-18.

The **center variable sliders on** options set the variable sliders to specific values.

Selection – <i>center variable sliders on ...</i>	Description
<i>Optimum</i>	Set variable sliders to optimum of current iteration
<i>Nearest history</i>	Set variable sliders to variable values of nearest history, this is the computed history with design point closest to selected design point for predicted history
<i>Selected point</i>	Set variable sliders to a selected point, e.g. a Pareto optimal solution Only active if there is only one selected point

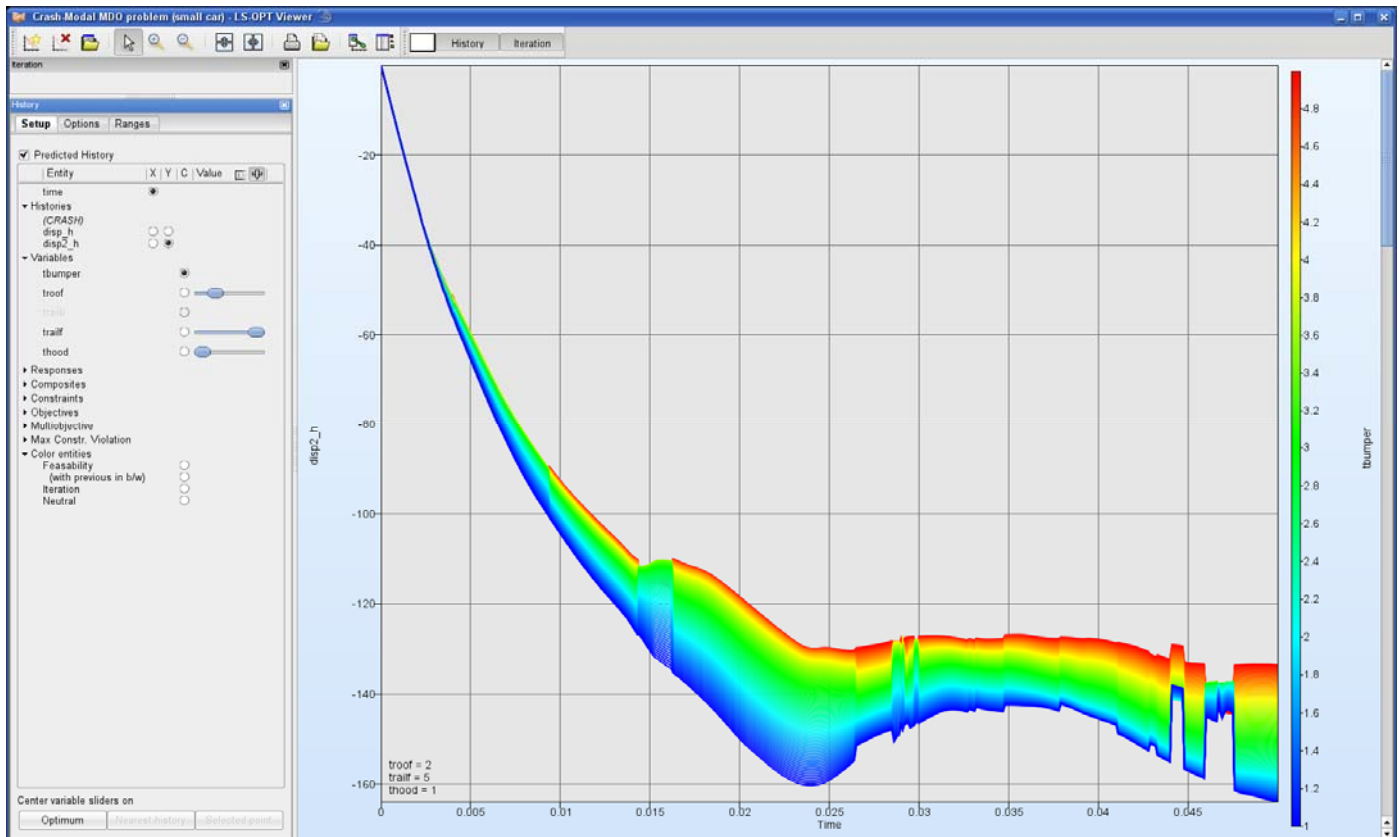


Figure 18-34: Predicted Histories colored by variable

## Options

Selection	Description
<i>Nearest</i>	Show computed history with design point closest to selected design point
<i>Maximal Residual</i>	Plot maximal residual
<i>Deviation Residual</i>	Plot standard deviation of residuals
<i>Number of predicted curves</i>	Number of plotted curves if histories are colored by variable

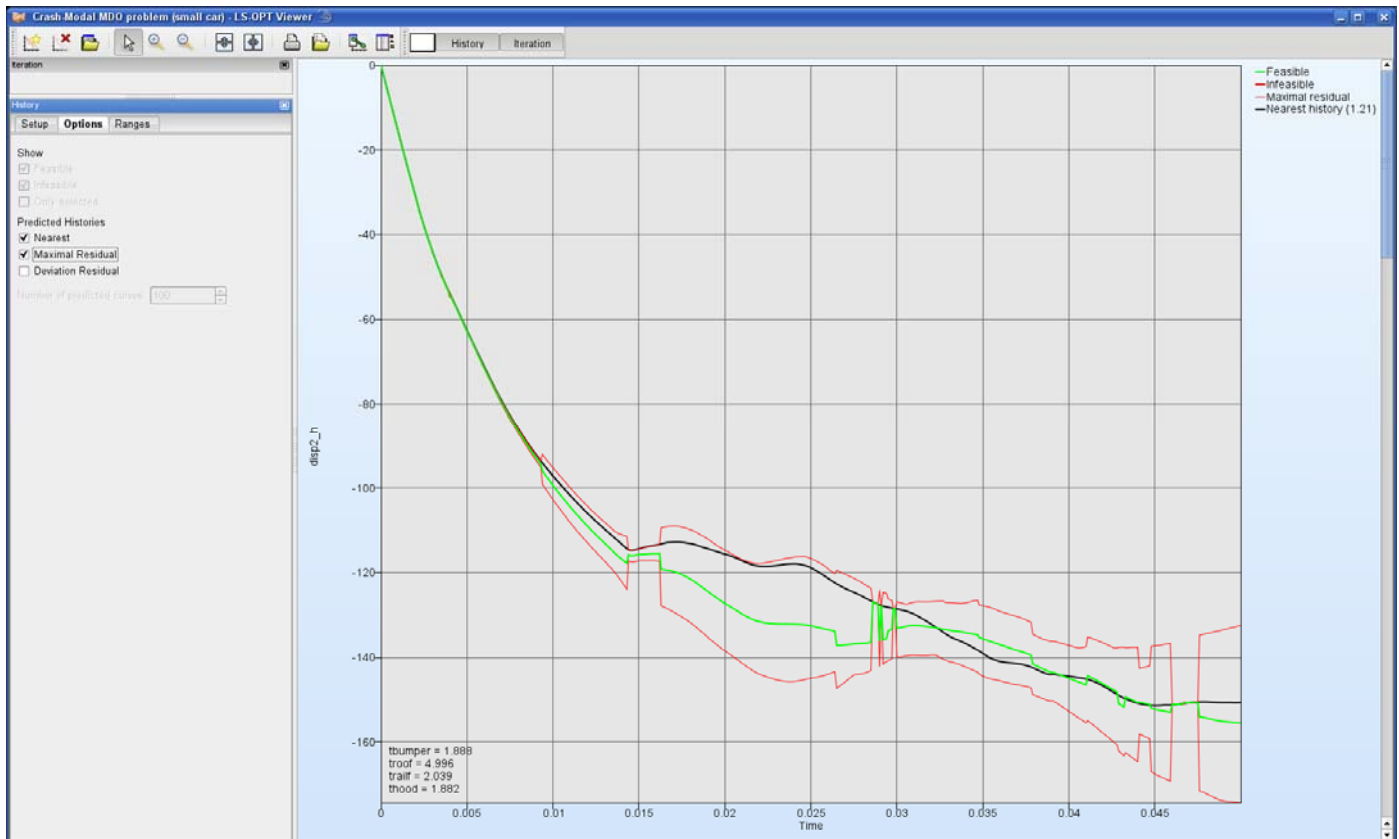


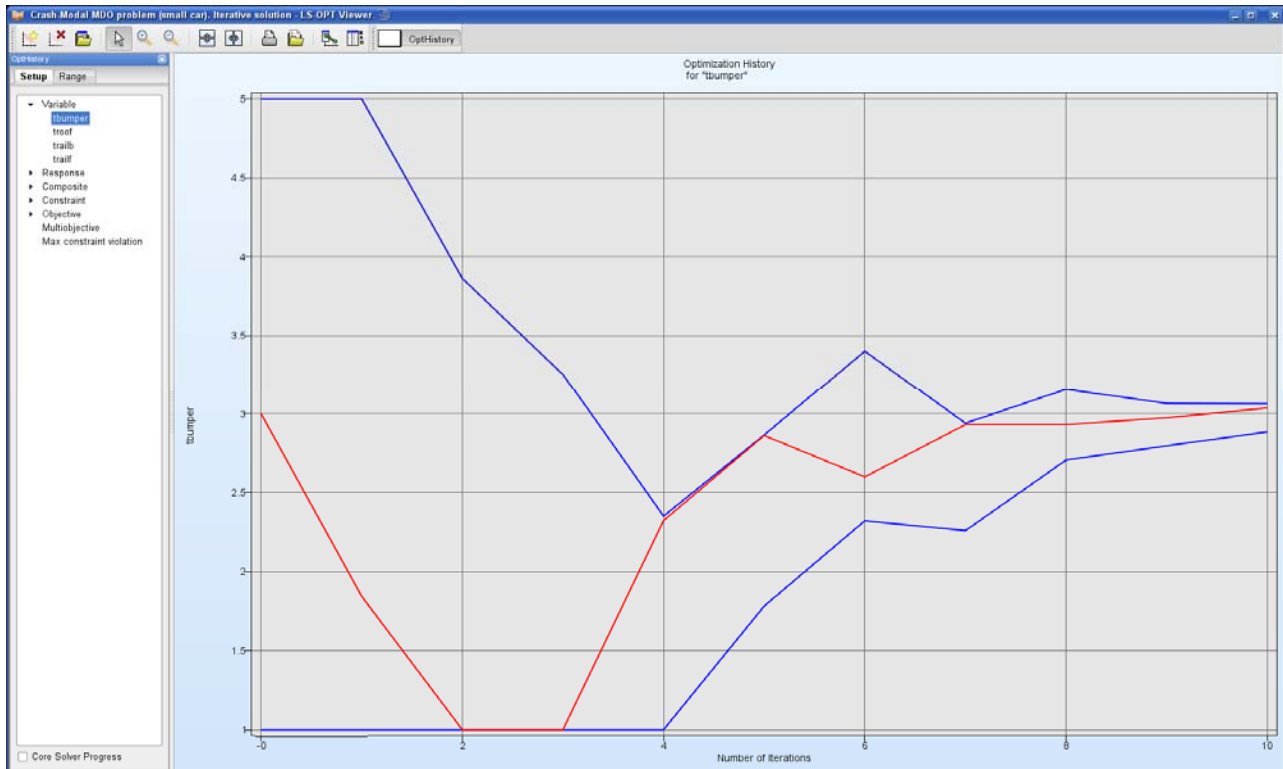
Figure 18-35: Predicted History with nearest history and maximal residual

## 18.4. Visualization of Optimization Results

### 18.4.1. Optimization History

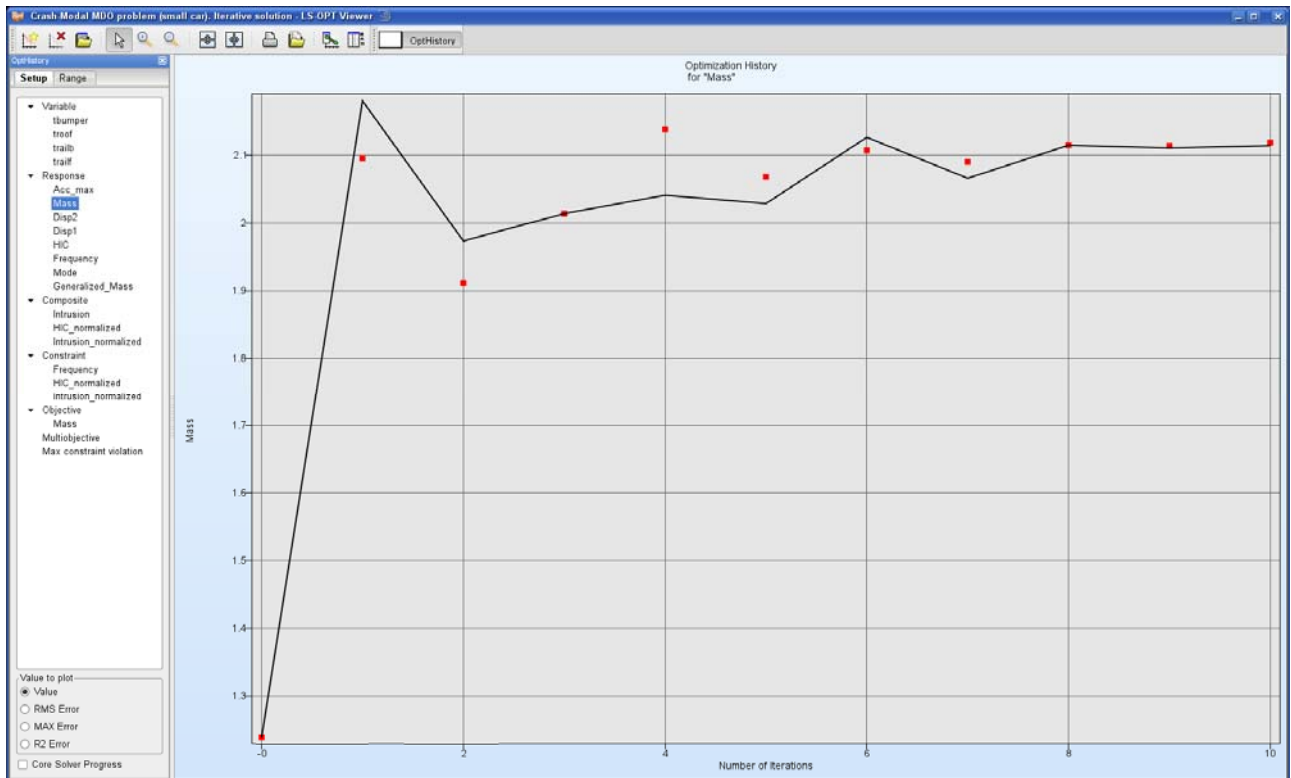
The optimization history of a variable, dependent, response, constraint, objective, multi-objective or the approximation error parameters of pure responses (not composites or expressions) shows the changes of the respective values of the optimum over the iterations. For the variables, the upper and lower bounds (subregion) are also displayed, Figure 18-36. For all the dependents, responses, objectives, constraints and maximum violation, a black solid line indicates the predicted values, while the red squares represent the computed values at the starting point of each iteration, Figure 18-37. For constraints, the lower and upper

bound are displayed with a blue and red line, respectively. For the error parameters, only one solid red line of the optimization history is plotted. RMS, Maximum and  $R^2$  error indicators are available.



**Figure 18-36: Optimization History plot of a variable – variable values (red) and subregions (blue)**

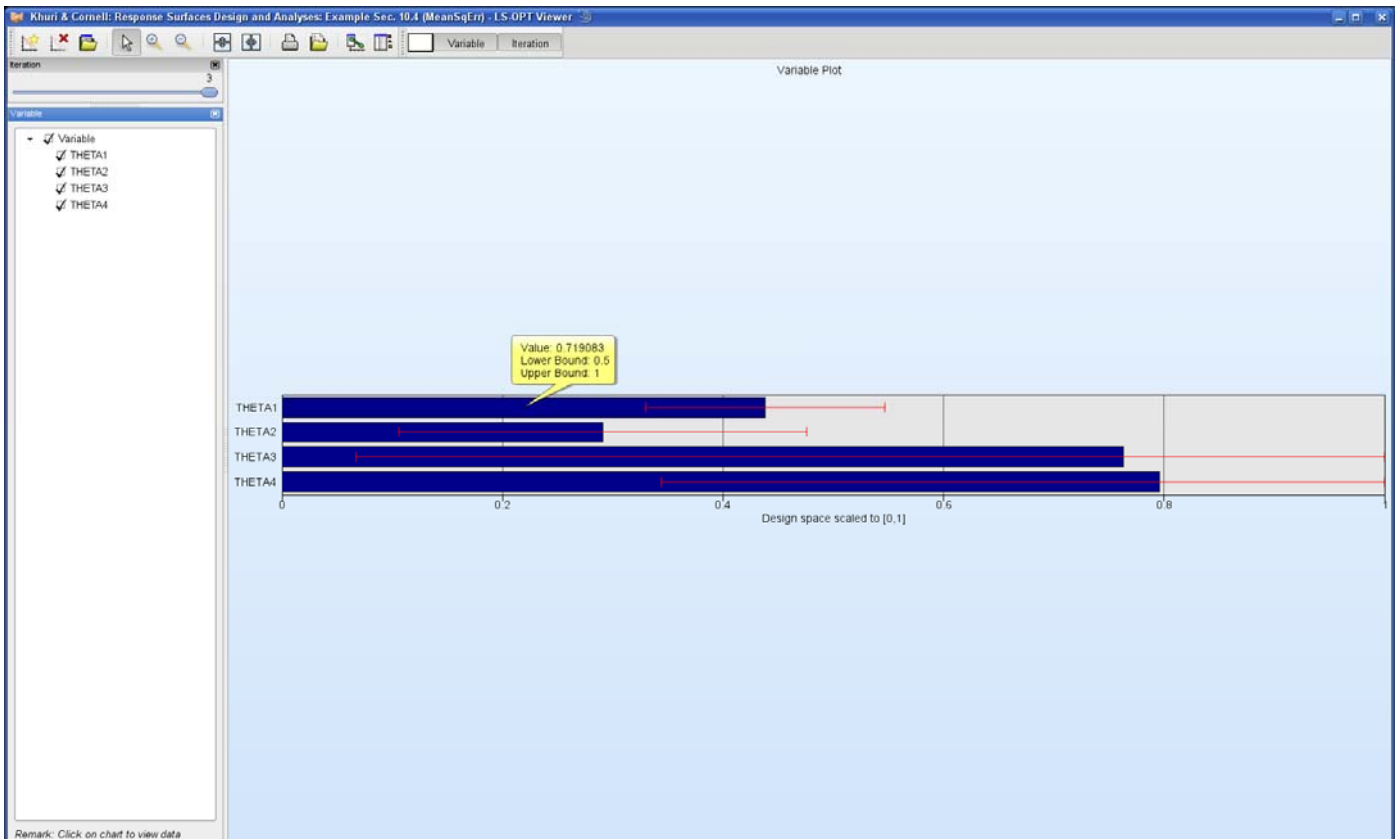




**Figure 18-37: Optimization History of a response – computed (red points) and predicted (black) values**

### 18.4.2. Variables Plot

The variables plot visualizes variable values and confidence intervals for \*.1 run of the selected iteration in a range scaled to [0,1], Figure 18-38. Clicking on the charts displays the actual value and the bounds on the plot.

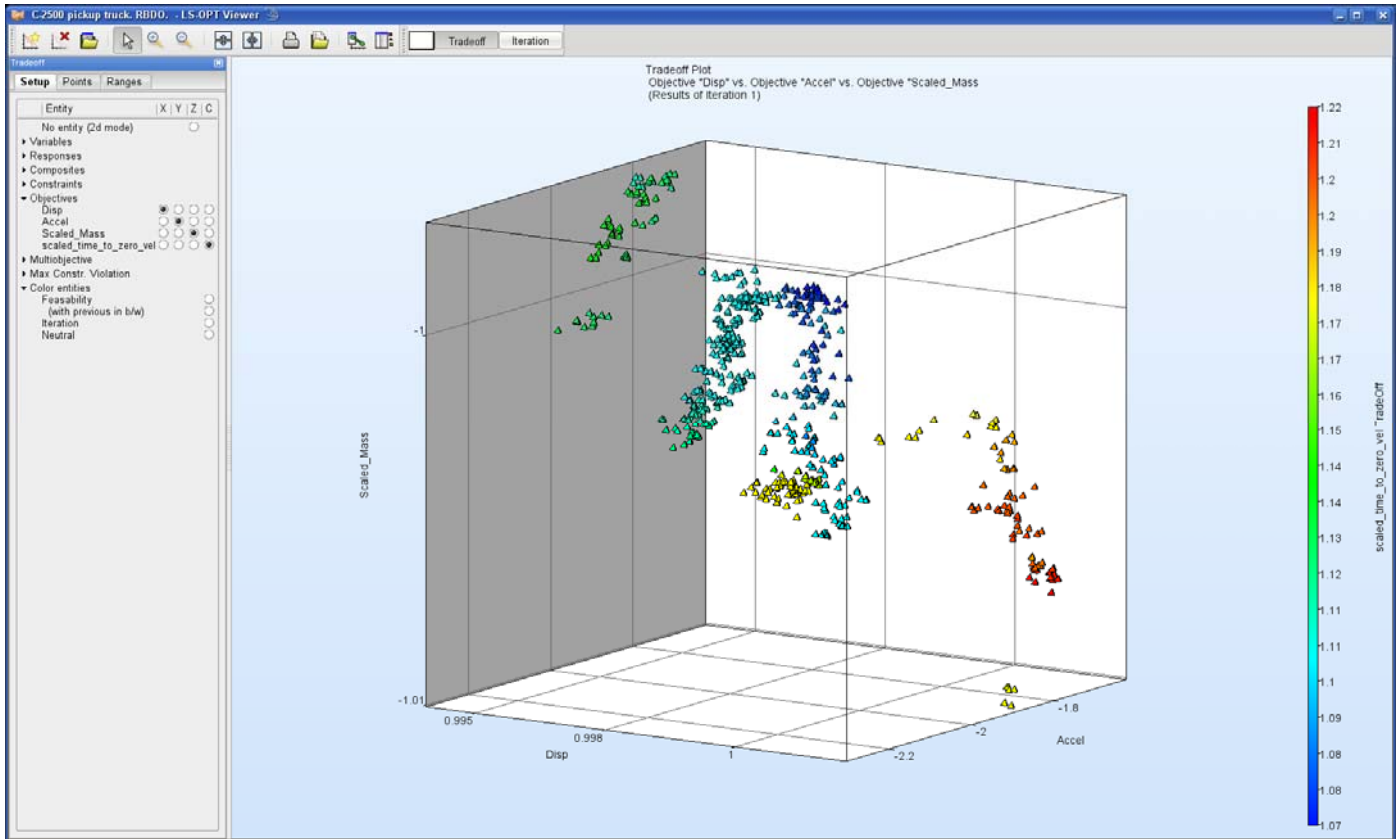


*Figure 18-38: Variable Plot*

## 18.5. Visualization of Pareto Optimal Solutions

### 18.5.1. Tradeoff Plot

The Tradeoff plot (Section 4.12.1) functions similar to the Scatter plot, Section 18.2.2, but the default setting is here to plot Pareto optimal solution data instead of Analysis Result data.



**Figure 18-39: Tradeoff plot**

### 18.5.2. Parallel Coordinate Plot

The Parallel Coordinate Plot (Section 4.12.3) in the Pareto optimal solutions category functions similar to the Parallel Coordinate Plot described in Section 18.2.3, but here, the default setting is to visualize Pareto data.

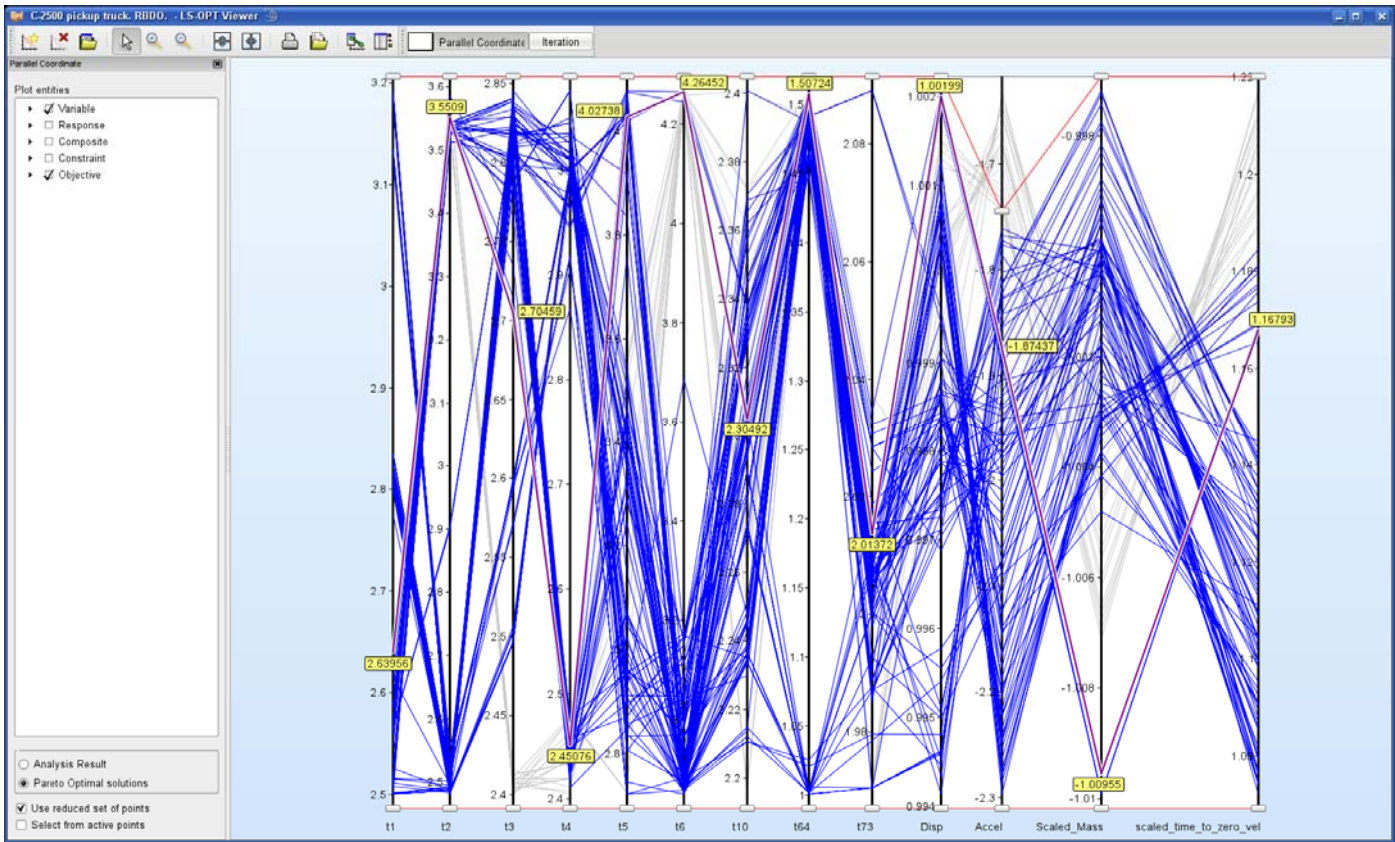


Figure 18-40: Parallel Coordinate Plot for Pareto optimal solutions with selected point (purple line)

### 18.5.3. Hyper-Radial Visualization

The hyper-radial visualization reduces multi-dimensional data to a two-dimensional graph by grouping the objectives and calculating a weighted sum for each group. These values are displayed in two dimensions. The designer may incorporate his preferences by selecting the weights. The best point with respect to the selected weights is colored purple in the plot, Figure 18-41.

The theory of hyper-radial visualization is explained in Section 4.12.2.

### Grouping

The objectives may be grouped using the 3-state buttons in the **Axis** column.

Selection	Description
<input type="checkbox"/> x	Add objective to the group displayed on the x axis
<input type="checkbox"/> y	Add objective to the group displayed on the y axis
<input type="checkbox"/>	Ignore objective

## Selection of Weights

The weights may be selected using the sliders or the text fields in the **Weights** column. The selected values represent the ratio of the weights and are scaled internally such that the sum of the weights is 1.

## Options

Selection	Description
<i>Use reduced set of points</i>	Plot only reduced set of Pareto optimal solutions
<i>Scale weights</i>	Scale weights by range of objectives
<i>Color Entity</i>	Color entity for HRV points

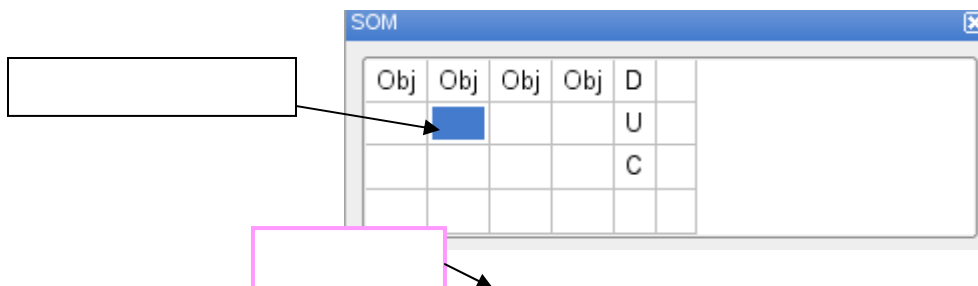
*Figure 18-41: Hyper-radial visualization, equal weights, points colored by variable*

### 18.5.4. Self-Organizing Maps

The theory of Self-Organizing Maps (SOM) is explained in Section 18.5.4.

#### Component Selection

By default, component maps of all objectives as well as the D-, U- and C-matrices are displayed. To modify the plot, select the position in the dynamic grid, Figure 18-42, and slot content, see Section 4.12.4. Describe the cell selection behaviour. D-, U-, C- maps. Refer to Section 4.12.4 for an explanation of the map types.



*Figure 18-42: Selection of position for SOM*

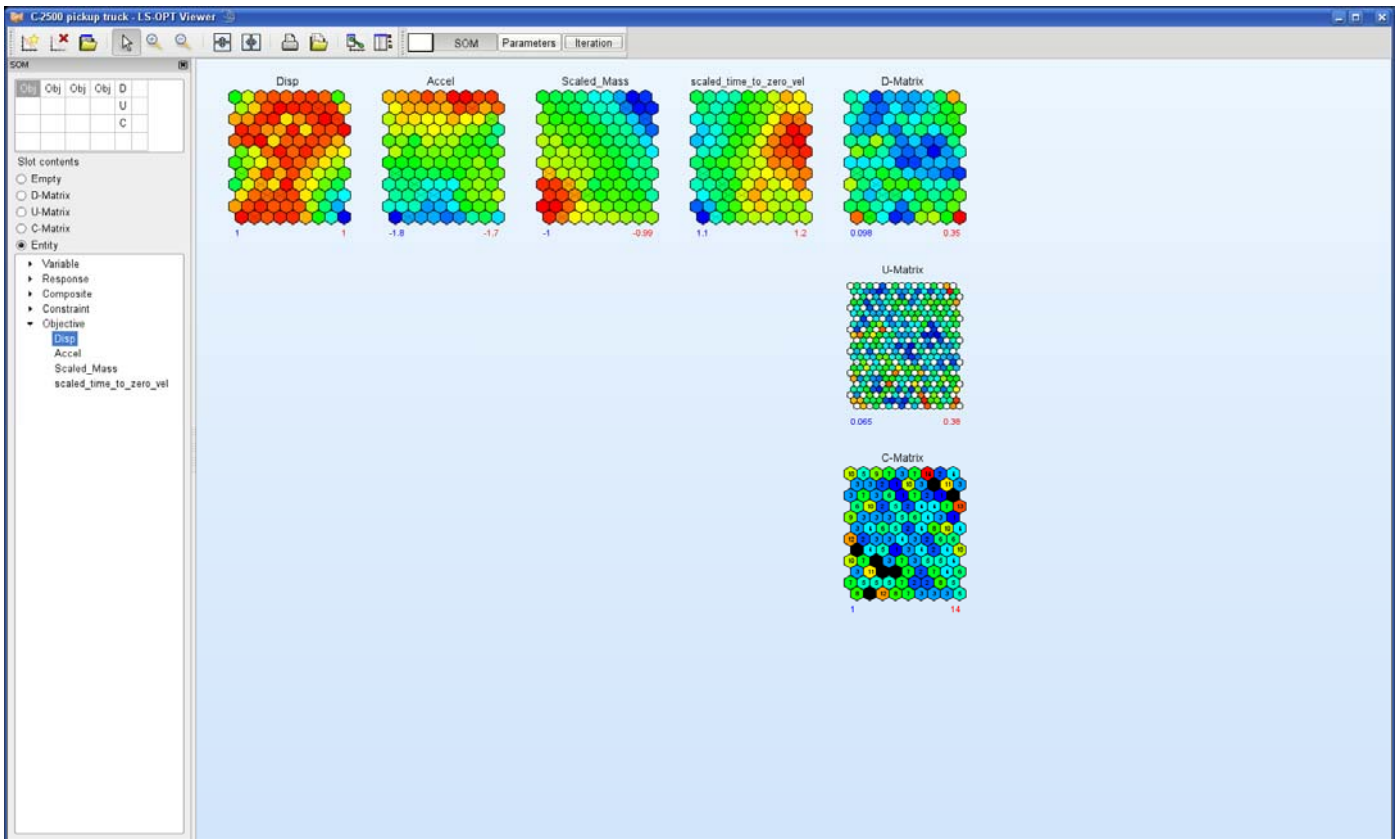


Figure 18-43: Self-Organizing Map, component plots of objectives and distance measure

## Parameter Panel

The advanced user may want to modify some parameters for the training of the SOM. These options are available in the **Parameters** panel. Modifications in the Parameter Panel effect retraining of the SOM.

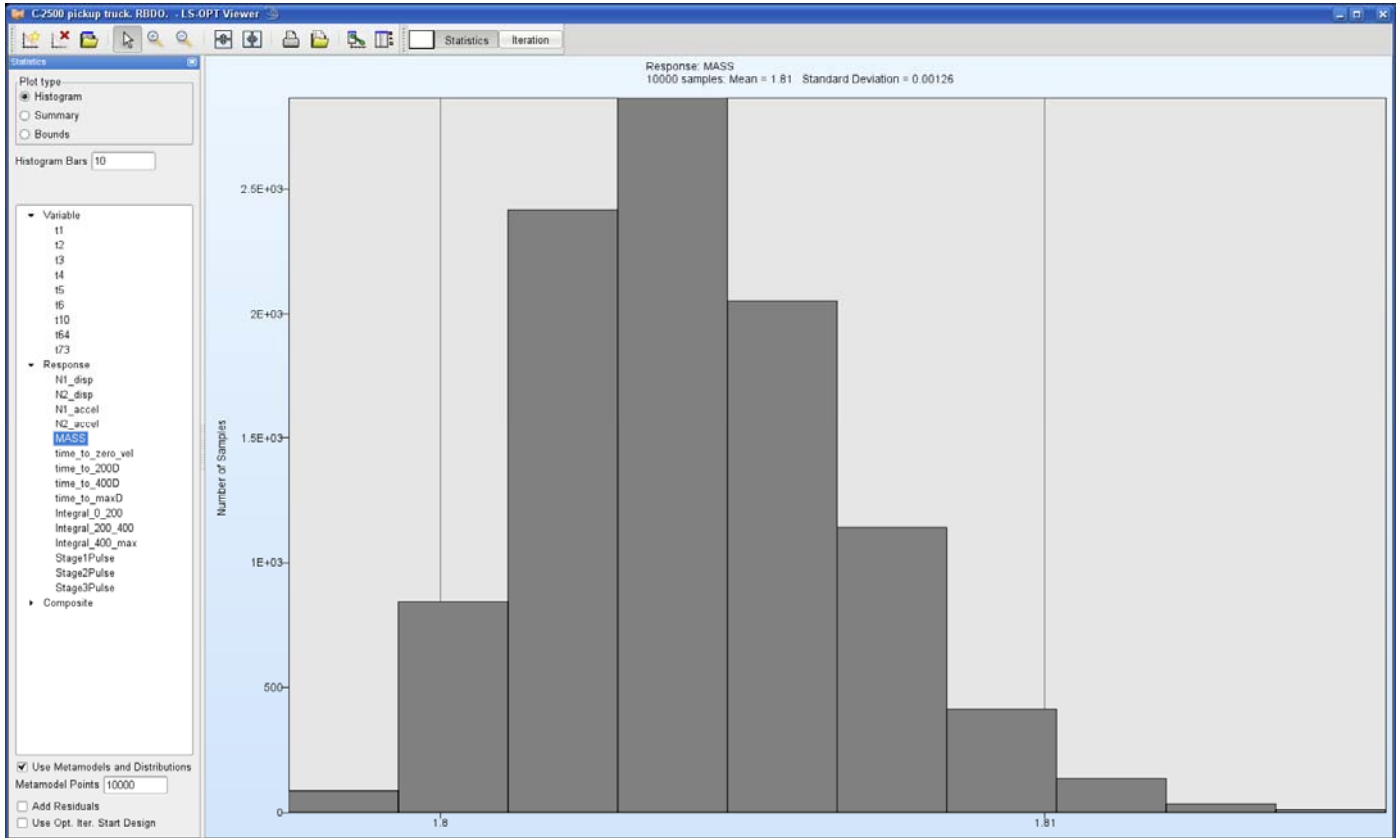
Selection	Description
<i>Training Iterations</i>	Number of iterations performed for training of SOM, default depends on honeycomb dimensions and number of data points
<i>Initial Radius</i>	Initial radius used for training of SOM, default depends on honeycomb dimensions
<i>Honeycomb dimensions</i>	Honeycomb dimensions, default 12x9

## 18.6. Stochastic Analysis

### 18.6.1. Statistics

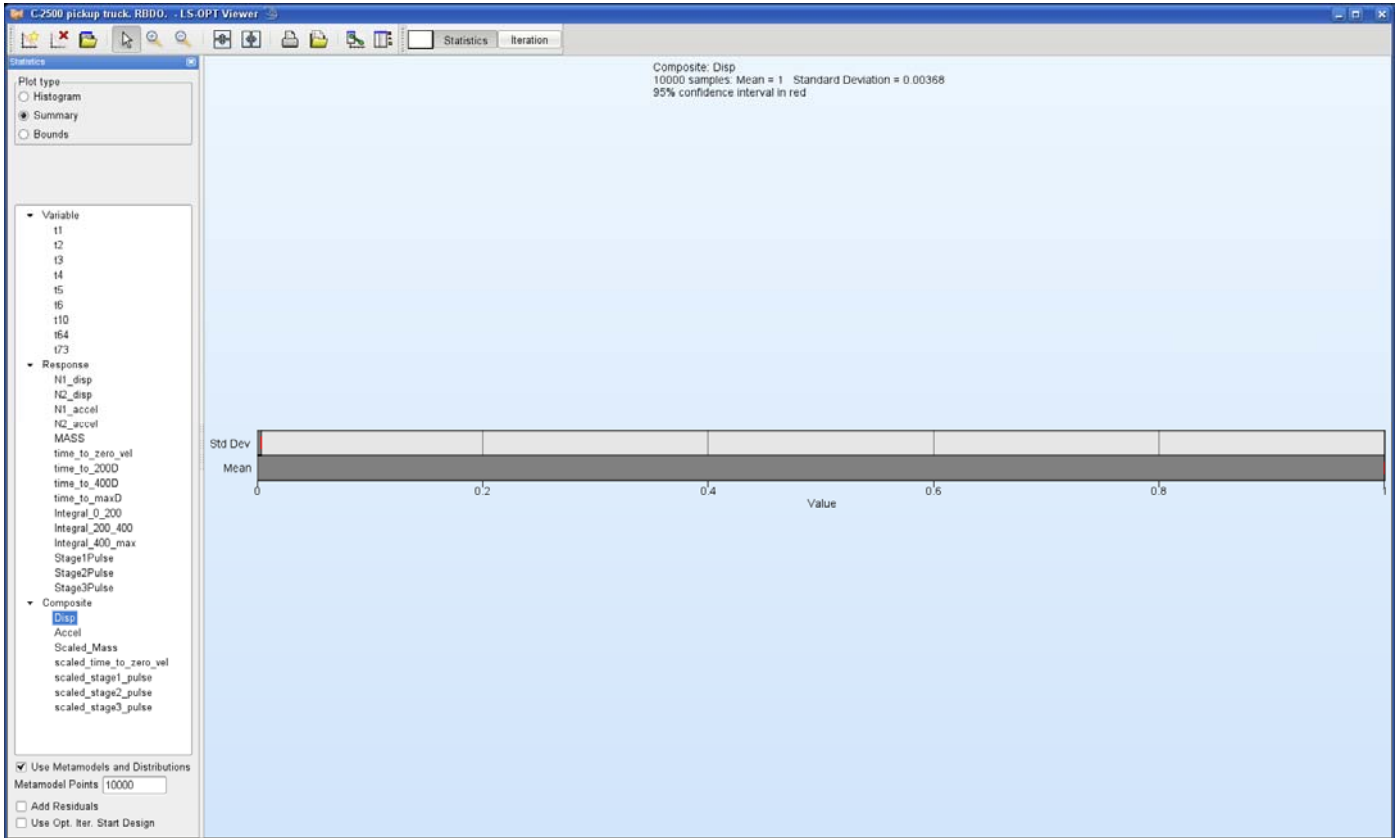
See Section 18.2.5.

## Histogram



**Figure 18-44:** Histogram constructed using metamodel together with the statistical distribution of the variables

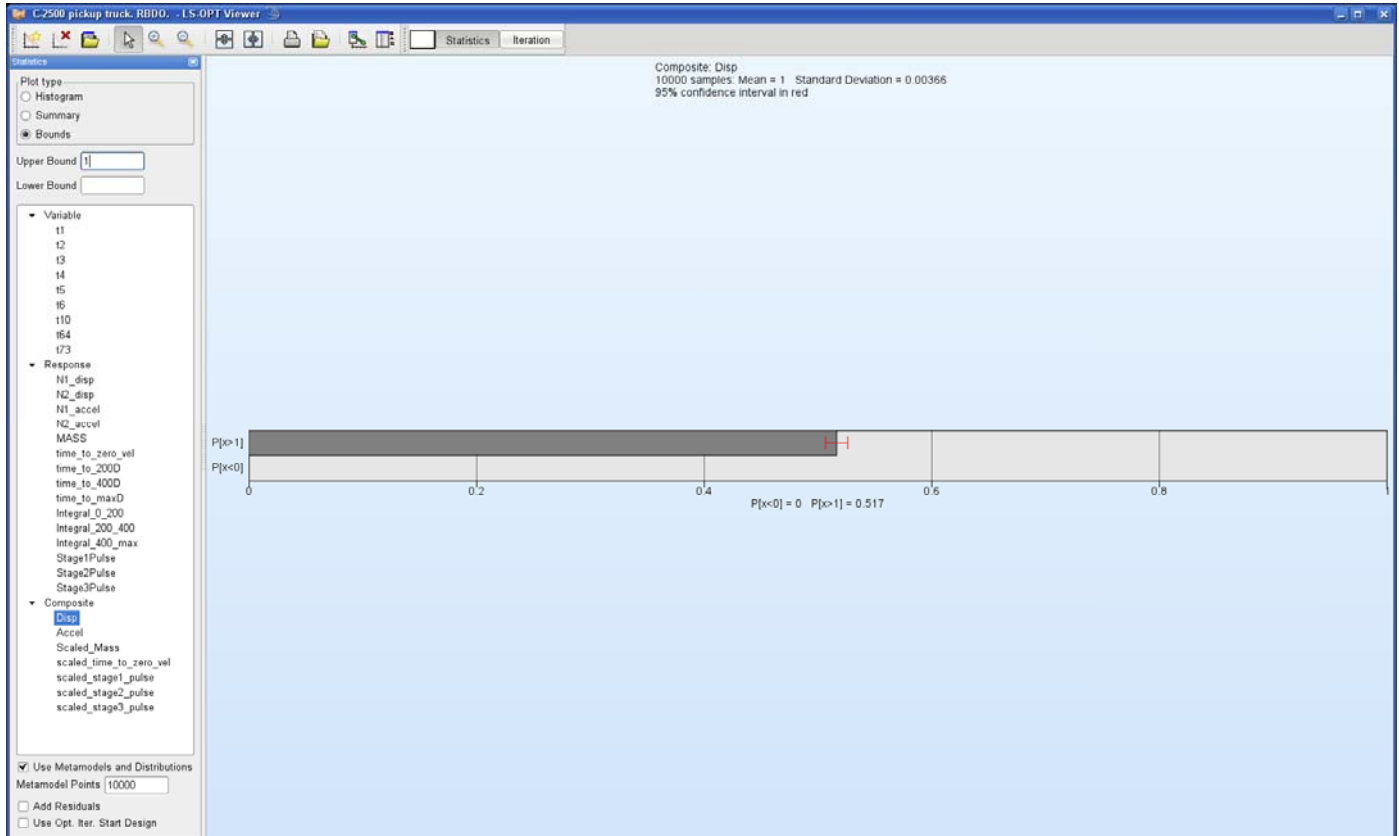
## Summary



*Figure 18-45: Mean value and standard deviation constructed using metamodel together with the statistical distribution of the variables*



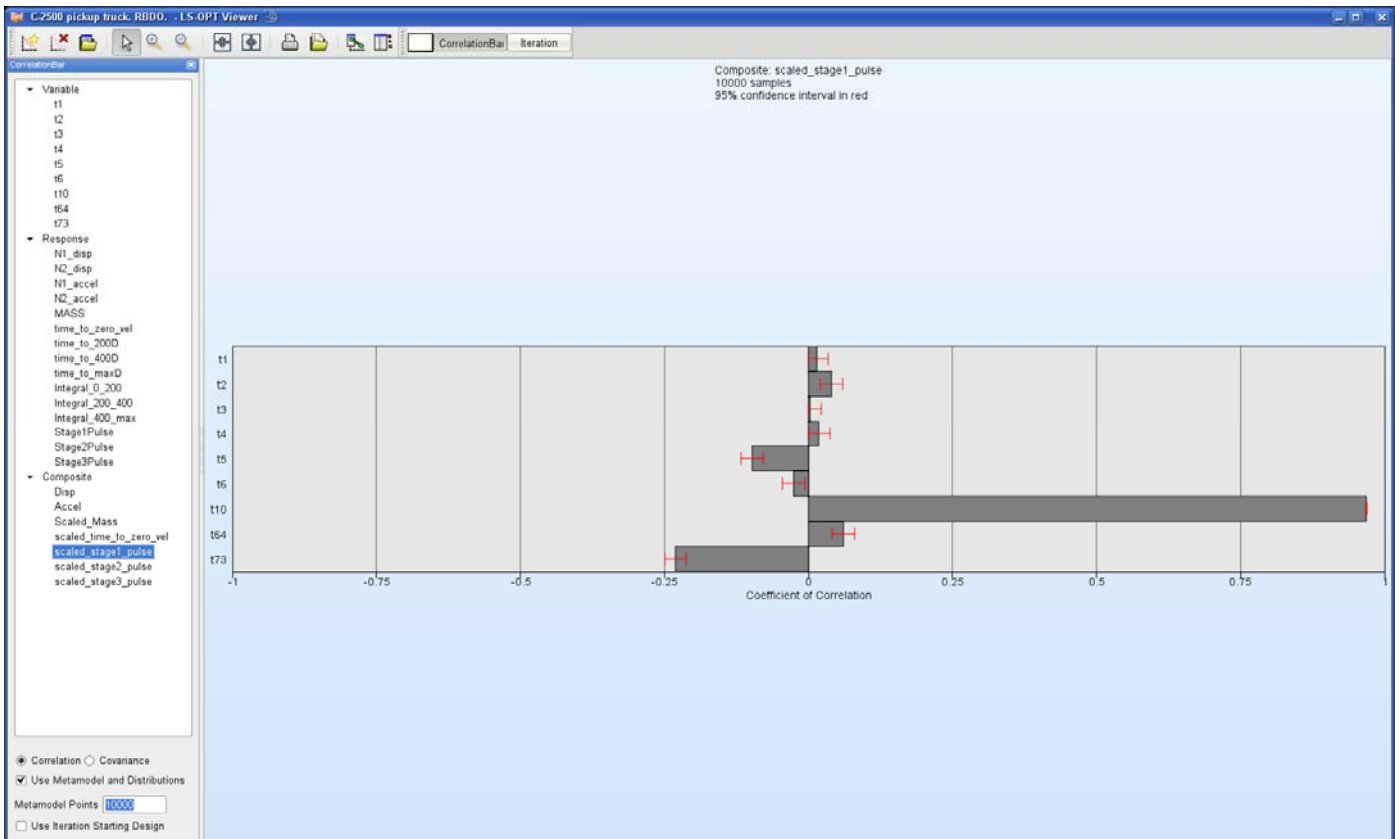
## Bounds



**Figure 18-46:** Probability of Composite Disp > 1 with 95% confidence interval in red constructed using metamodel together with the statistical distribution of the variables

### 18.6.2. Correlation Bars

See Section 18.2.6.



**Figure 18-47: Correlation Bars evaluated on metamodel**

### 18.6.3. Stochastic Contribution

The stochastic contribution of the variables to the variance of the responses and composites (see Section 6.7) can be displayed as a bar chart.

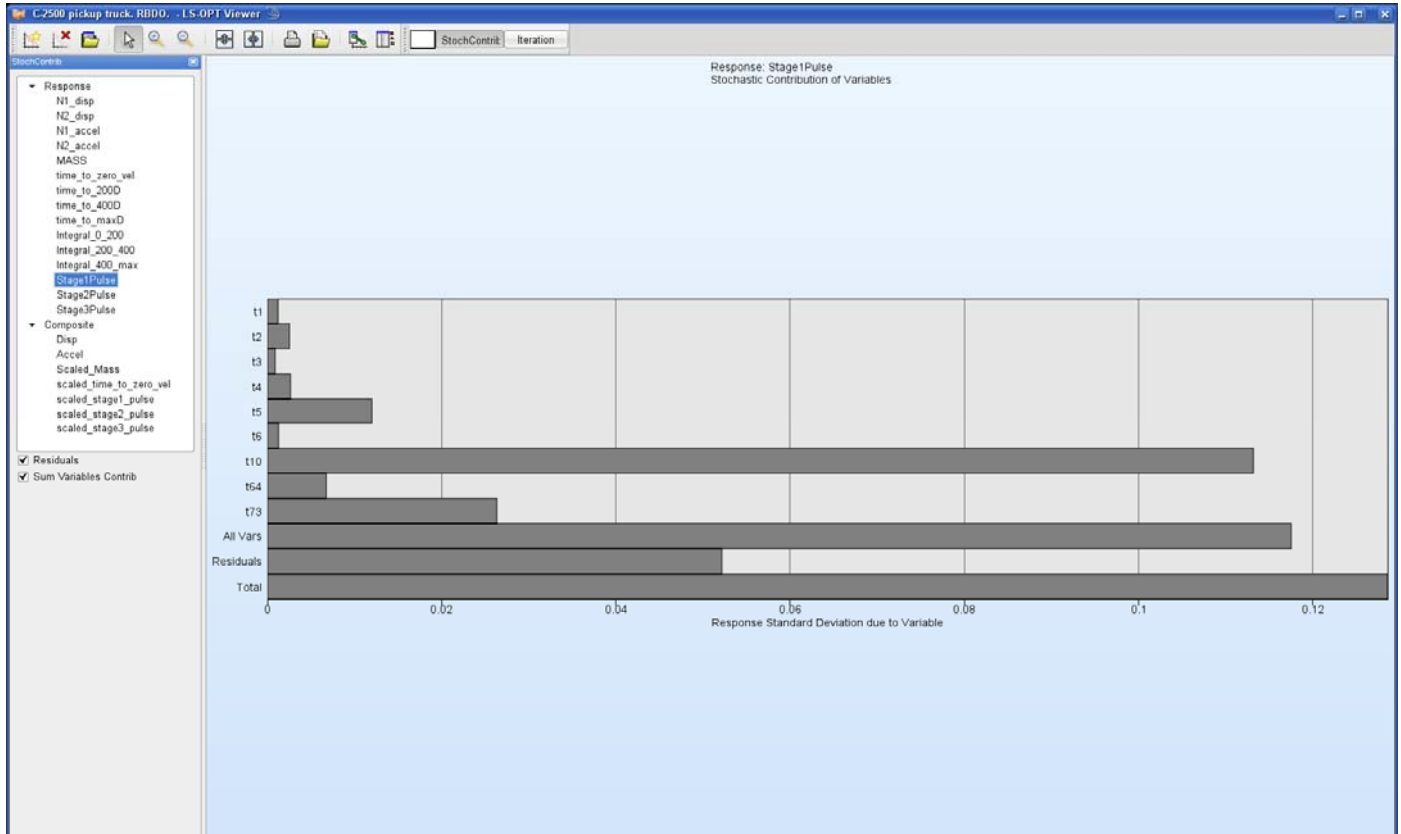
Optionally the user can elect to display the influence of the residuals from the metamodel fit and the effect of all the variables summed together. Contrasting these two values indicates how well the cause-effect relationship for the specific response is resolved. If both the residuals and the sum of the contributions are requested, then a total is displayed that is the sum of the contributions of all the variables as well as the residuals.

The computations are done using the metamodels and stored in databases for visualization.

Higher order effects, if any, are included in the results plotted. In the Sobol terminology, the total effect as opposed to the main effect is therefore plotted. See Section 6.7 for the details.

For optimization the stochastic contribution is computed using the optimal design.

The stochastic contribution panel is shown in Figure 18-48.



**Figure 18-48: Stochastic Contribution plot**

## 18.7. References

- [1] Myers, R.H. and Montgomery, D.C. *Response Surface Methodology. Process and Product Optimization using Designed Experiments*. Wiley, 1995

# 19. Applications of Optimization

This chapter provides a brief description of some of the applications of optimization that can be performed using LS-OPT. It should be read in conjunction with Chapter 22, the Examples chapter, where the applications are illustrated with practical examples.

## 19.1. Multidisciplinary design optimization (MDO)

The MDO capability in LS-OPT implies that the user has the option of assigning different variables, experimental designs and job specification information to different solvers or disciplines. The directory structure change that has been incorporated in this version, separates the number of experiments that needs to be run for each solver by creating separate `Experiments`, `AnalysisResults`, `DesignFunctions` and `ExtendedResults` files in each solver directory.

### Command file syntax:

---

```
mdo mdtype
```

---

The only `mdotype` available is `mdf`, or multidisciplinary feasible.

#### 19.1.1. Command file

All variable definitions are defined first, as when solving non-MDO problems, regardless of whether they belong to all disciplines or solvers. This means that the variable starting value, bounds (minimum and maximum) and range (sub-region size) are defined together. If a variable is *not* shared by all disciplines, however, i.e., it belongs to some but not all of the disciplines (solvers), then it is flagged using the syntax `local variable_name`. At this stage, no mention is made in the command file to which solver(s) the particular variable belongs. This reference is made under the solver context, where the syntax `Solver variable variable_name` is used.

See the examples in Section 22.6 for the command file format.

## 19.2. Worst-case design

The default setting in LS-OPT is that all design variables are treated as minimization variables. This means that the objective function is minimized (or maximized) with respect to all the variables. Maximization variables are selected in the Variables panel (see Figure 11-1) by toggling the required variables from ‘Minimize’ to ‘Maximize’.

## 19.3. Reliability-based design optimization (RBDO)\*

LS-OPT has a reliability-based design capability based on the computation of the standard deviation of any response. The theoretical concerns are discussed in Section 5.5.

The method computes the standard deviation of the responses using the same metamodel as used for the deterministic optimization portion of the problem using the First Order Second Method (FOSM) or First Order Reliability Method (FORM) method. No additional FE runs are therefore required for the probabilistic computations.

The method requires very little information additionally to what is required for deterministic optimization. Specify the following:

1. Statistical distributions associated with the design variables
2. Probabilistic bounds on the constraints.

The statistical distributions associated with the design variables are specified in the same manner as for a Monte Carlo analysis using a metamodel.

The current GUI support is the same as for deterministic design optimization and Monte Carlo analysis.

### Command file syntax:

---

```
probability upper bound constraint 'con_name' upper_bound  
probability lower bound constraint 'con_name' lower_bound  
iterate number_of_iterations
```

---

An example is given in Section 22.2.11.

# 20. Optimization Algorithm Selection and Settings

This chapter describes the parameter settings for the optimization methods, strategies and algorithms used in LS-OPT. The default parameters should be sufficient for most optimization applications. The following sections describe how to choose an optimization strategy and modify the default settings.

## 20.1. Introduction

The two basic optimization branches are Metamodel-based optimization and Direct optimization. Metamodel-based optimization is used to create and optimize an approximate model of the design instead of optimizing the design through direct simulation. The metamodel is thus created as a simple and inexpensive surrogate of the actual design. Once the metamodel is created it can be used to find the optimum or, in the case of multiple objectives, the Pareto Optimal Front.

In this section different strategies for building a metamodel are discussed. The strategies depend mostly on whether the user wants to build a metamodel that can be used for global exploration or whether she is only interested in finding an optimal set of parameters. An important criterion for choosing a strategy is also whether the user wants to build the metamodel and solve the problem iteratively or whether he has a "simulation budget" i.e. a certain number of simulations and just wants to use the budget as effectively as possible to build a metamodel for improving the design and obtaining as much information about the design as possible.

## 20.2. Selecting an optimization methodology

The syntax is as follows:

### Command file syntax:

---

```
Optimization method [srsm|genalg]
```

---

Metamodel-based optimization (`srsm`) is the default. Note that the choice of the Direct Genetic Algorithm may require a large number of simulations. The method selections can be made in the GUI using the Task button in the menu bar at the top of the GUI.

## 20.3. Selecting strategies for metamodel-based optimization

### Command file syntax:

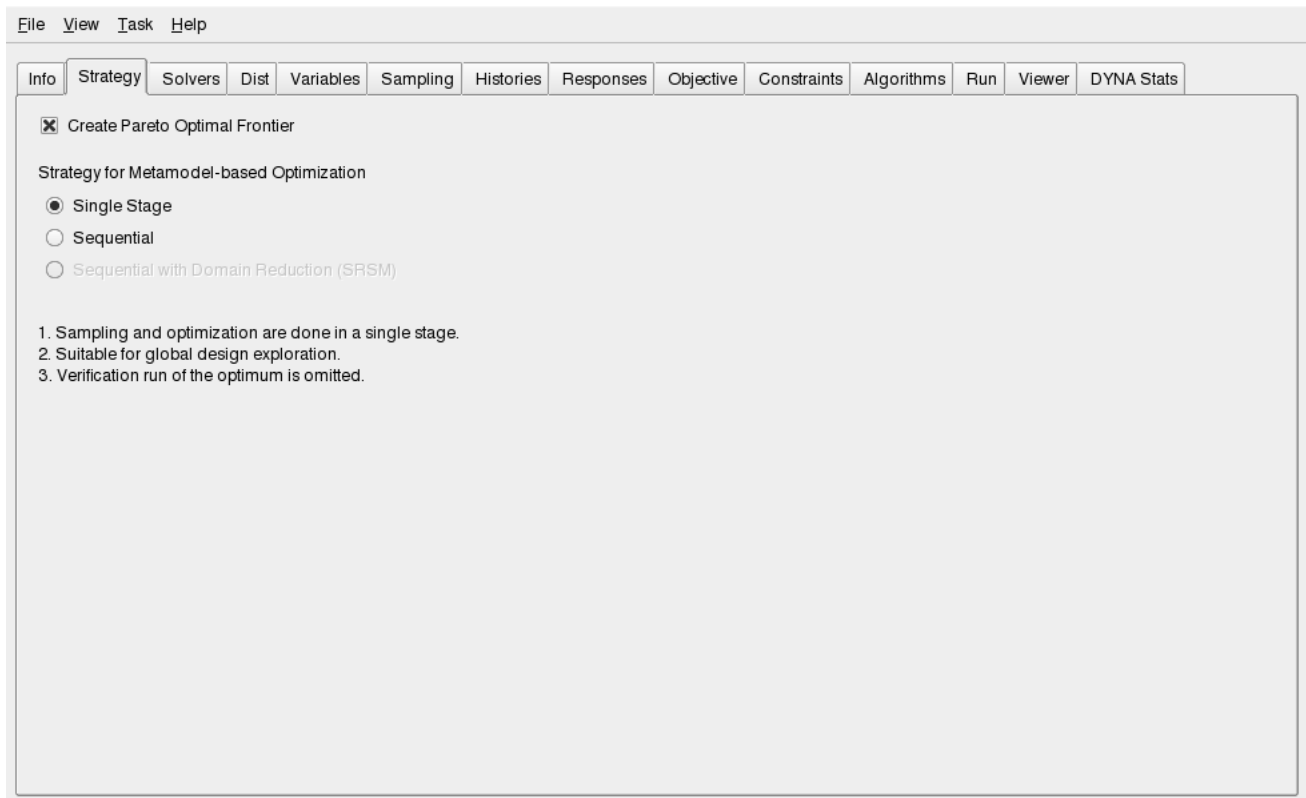
---

```
Metamodel Optimization Strategy [SINGLESTAGE | SEQUENTIAL |
DOMAINREDUCTION]
```

---

There are three available strategies for automating the metamodel-based optimization procedure. These strategies only apply to the tasks Metamodel-based Optimization and RBDO. In the GUI, the strategies are selected in the "Strategy" panel. The available optimization strategies are (i) Single Stage, (ii) Sequential and (iii) Sequential with Domain Reduction (SRSM).

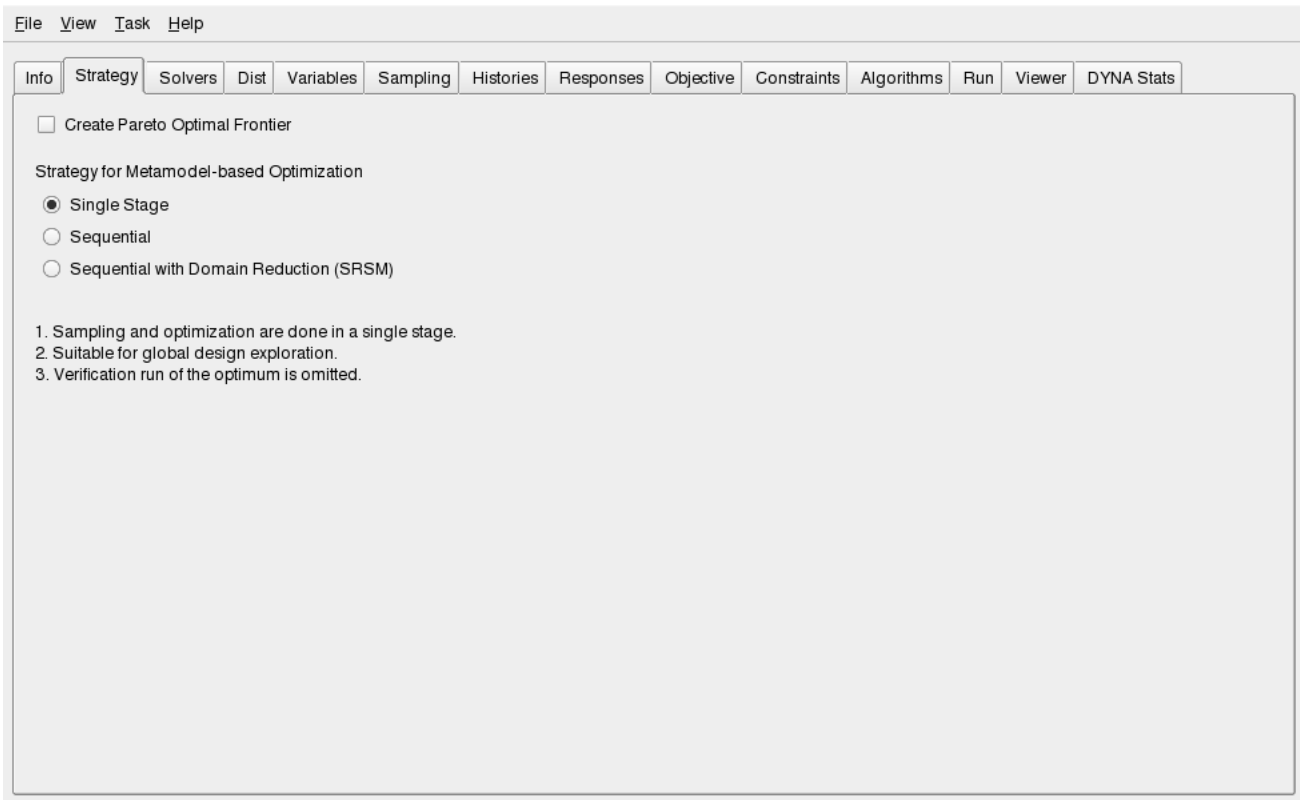
This is the only panel in which the Pareto Optimal Frontier (see Section 4.9.2) can be selected and the panel starts with this option. Selection limits the available options to the *global* strategies Single Stage and Sequential (see Figure 20-1). The remaining option (Sequential with Domain Reduction) is typically only used for optimization in which the user is only interested in the final optimum point (such as parameter identification) and not in any global exploration of the design. A strategy selection resets the Sampling panel (a warning is given!), Algorithms panel and Run panel with recommended selections. The strategies are discussed one by one.



**Figure 20-1: Selection to create Pareto Optimal Front showing the available two global strategies**

### 20.3.1. Single stage

In this approach, the experimental design for choosing the sampling points is done only once. The metamodel selection defaults to Radial Basis Function Networks with Space Filling as the sampling scheme. The verification run is omitted by default. The setting is shown in Figure 20-2 and is the default option.

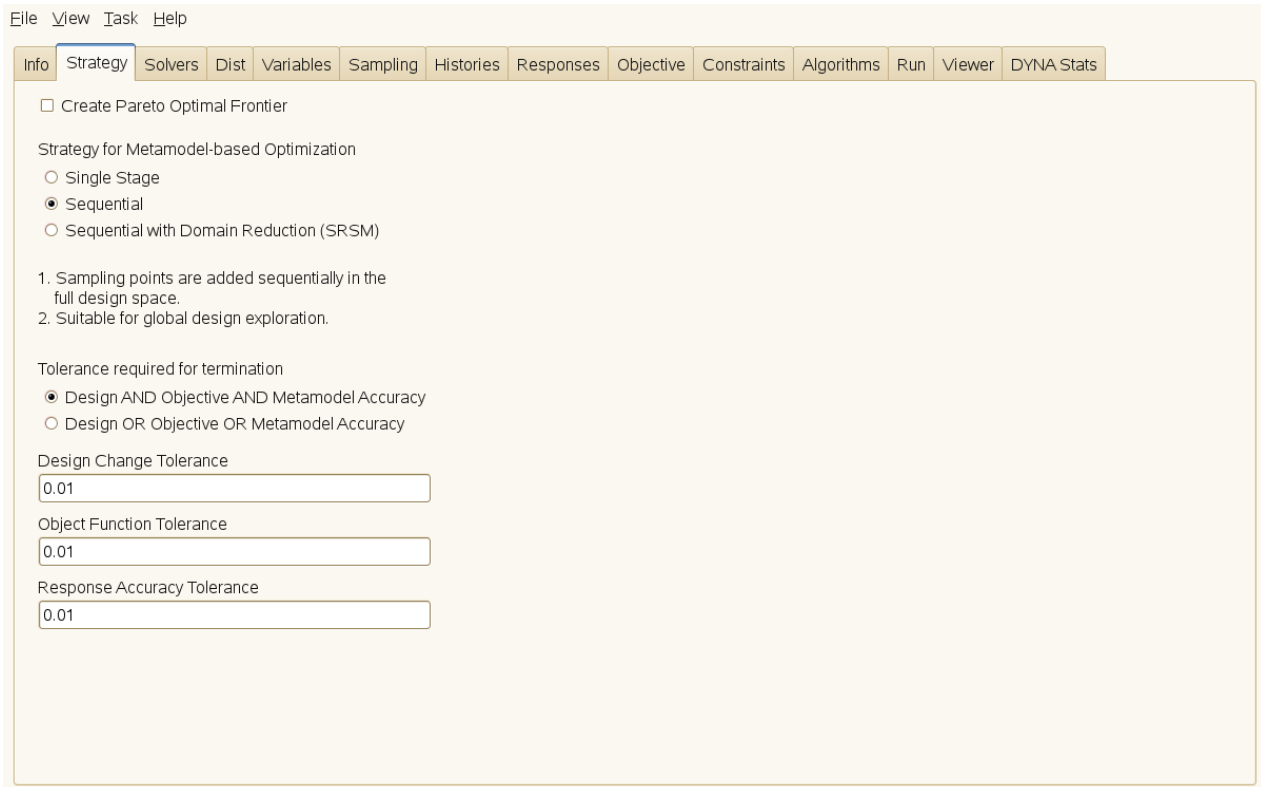


*Figure 20-2: Single Stage strategy selected in the Strategy tab*

### 20.3.2. Sequential strategy

In this approach, sampling is done sequentially. A small number of points is typically chosen for each iteration and multiple iterations can be requested in the Run panel. The approach has the advantage that the iterative process can be stopped as soon as the metamodels or optimum points have achieved sufficient accuracy. The setting is shown in Figure 20-3.





**Figure 20-3: Sequential strategy selected in Strategy tab**

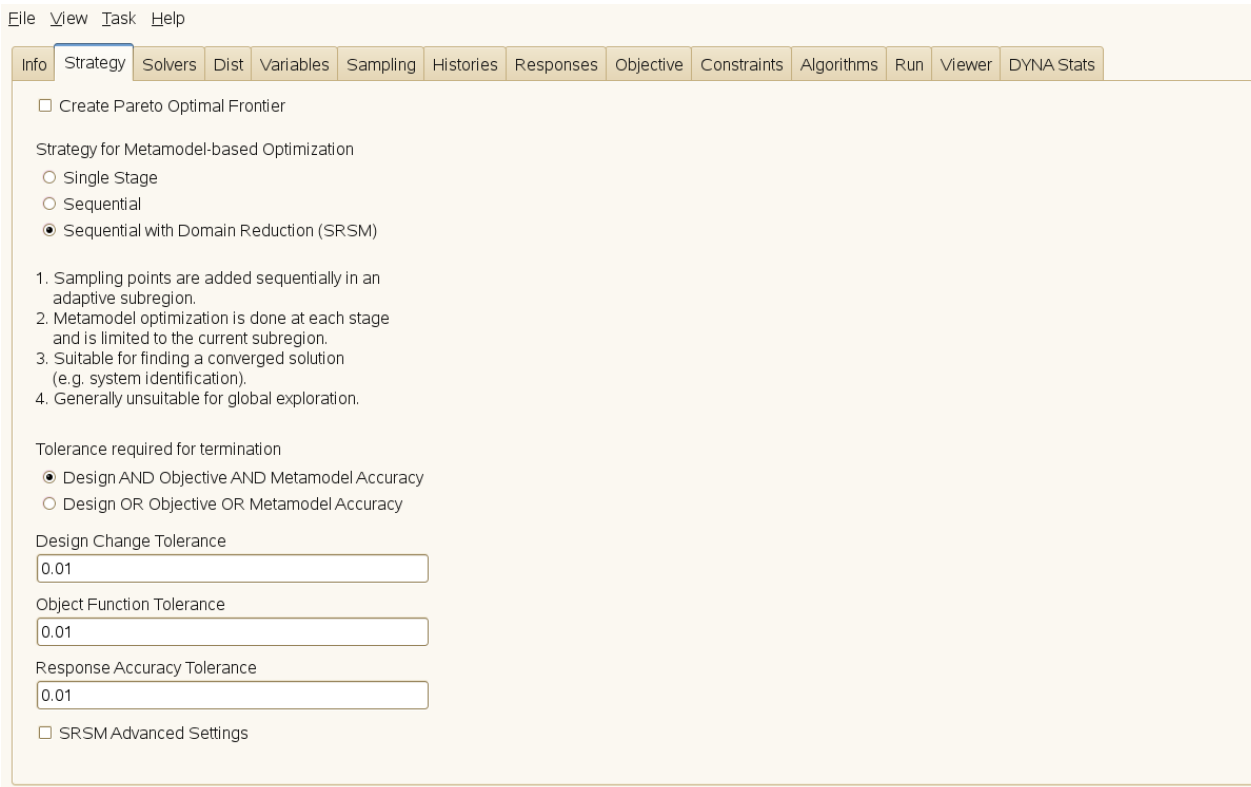
The default settings for sampling follow below (see Sampling panel):

1. Radial Basis Function networks
2. Space Filling sampling.
3. The first iteration is Linear D-Optimal.
4. Choose the number of points per iteration to not be less than the default for a linear approximation  $(1.5(n + 1) + 1)$  where  $n$  is the number of variables.

It was demonstrated in Reference [16] that, for Space Filling, the Sequential approach had similar accuracy compared to the Single Stage approach, i.e.  $10 \times 30$  points added sequentially is almost as good as 300 points. Therefore both the Single Stage and Sequential Methods are good for design exploration using a metamodel. Both these strategies work better with metamodels other than polynomials because of the flexibility of metamodels such as RBF's to adjust to an arbitrary number of points.

### 20.3.3. Sequential strategy with domain reduction

This approach is the same as that in 20.3.2 but, in order to accelerate convergence, the domain reduction strategy is used to reduce the size of the subregion. During a particular iteration, the subregion is used to bind the positions of new points. Figure 20-4 shows the selection of a domain reduction scheme.



**Figure 20-4: Sequential Strategy with Domain Reduction selected in the Strategy tab.**

The default domain reduction approach is SRSM which is the original LS-OPT design automation strategy. It allows the building of a new response surface (typically linear polynomial) in each iteration. The size of the subregion is automatically adjusted for each iteration (see Section 4.6) and points belonging to previous iterations are ignored. This method is only suitable for convergence to an optimum, cannot be used to construct a Pareto Optimal Front and is not recommended for any other type of design exploration. The method is ideal for system identification (see Section 5.3).

The default settings for sampling are listed below (see Sampling panel):

1. Linear polynomial
2.  $D$ -optimal sampling
3. Default number of sampling points based on the number of design variables (see Table 2-1).

## 20.4. Domain reduction in metamodel-based optimization

### 20.4.1. Setting the subdomain parameters

To automate the successive subdomain scheme for SRSM, the size of the region of interest (as defined by the range of each variable) is adapted based on the accuracy of the previous optimum and also on the occurrence of oscillation (see theory in Section 4.6).

The following parameters can be adjusted (refer also to Section 4.6). A suitable default has been provided for each parameter and the user should not find it necessary to change any of these parameters. They can also be set in the GUI (see Figure 20-5).

**Table 20-1: Subdomain parameters and default values**

Item	Parameter	Default	
		SRSM	SRSM (NN)
objective	Tolerance on objective function accuracy $\epsilon_f$	0.01	0.01
design	Tolerance on design accuracy $\epsilon_x$	0.01	0.01
stoppingtype	and: objective <i>and</i> design; or: objective <i>or</i> design	and	and
response	Tolerance on accuracy of response surface $\epsilon_r$	0.01	0.01
psi	$\gamma_{pan}$	1.0	1.0
gamma	$\gamma_{osc}$	0.6	1.0
eta	Zoom parameter $\eta$	0.6	0.75

\* Applied when the design has not changed.

**Command file syntax:**

---

`iterate param parameter_identifier value`

---

The iterative process is terminated if the following convergence criteria become active:

$$\left| \frac{f^{(k)} - f^{(k-1)}}{f^{(k-1)}} \right| < \epsilon_f$$

and/or

$$\frac{\|x^{(k)} - x^{(k-1)}\|}{\|d\|} < \epsilon_x$$

or

$$\left| s_i^{(k)} - s_i^{(k-1)} \right| < \epsilon_r$$

where  $x$  refers to the vector of design variables,  $d$  is the size of the design space,  $f$  denotes the value of the objective function,  $s_i$  denotes the approximation error of  $i^{th}$  response characterized by the ratio of square root PRESS statistics and the mean value of response and,  $(k)$  and  $(k - 1)$  refer to two successive iteration numbers. The `stoppingtype` parameter is used to determine whether (and) or (or) will be used, e.g.,

```
iterate param design 0.001
iterate param objective 0.001
iterate param stoppingtype or
iterate param response 0.01
```

implies that the optimization will terminate when either criterion is met.

## 20.4.2. Changing the behavior of the subdomain

### Resetting the subdomain range

It is possible to reset the subregion range to the initial range, e.g. for adding points in the full design space (or any specified range around the optimum) after an optimization has been conducted. This feature is typically only used in a restart mode. The GUI option is "Reset to Initial Range on Iteration" (Figure 20-5).

#### Command file syntax:

---

```
iterate param reset range iteration iteration_number
```

---

#### Example:

```
iterate param reset range iteration 3
```

The point selection of iteration 3 will be conducted in the initial range around the most recent optimum point. Full adaptivity will be applied again starting with iteration 4.

### Freezing the subdomain range

This feature allows for points to be added without changing the size of the subregion. Adaptivity can be frozen at a specified iteration number. The GUI option is "Freeze Range from iteration" (Figure 20-5).

#### Command file syntax:

---

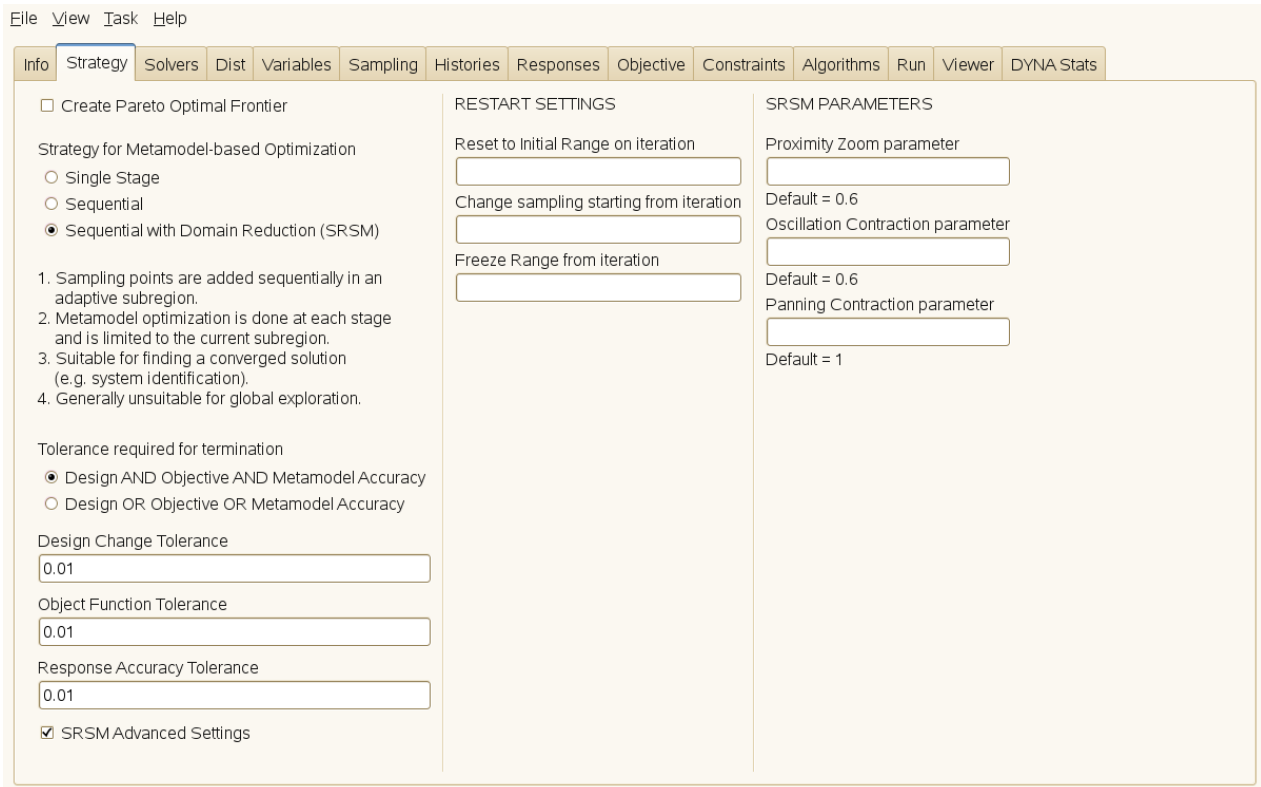
```
iterate param adapt off iteration iteration_number
```

---

#### Example:

```
iterate param adapt off iteration 3
```

Adaptivity will be applied up to the second iteration. Therefore iterations 3 and higher will have the same range (although the region of interest may be panning). The flag is useful for adding points to the full design space without any changes in the boundaries.



**Figure 20-5: Setting the domain reduction parameters using SRSM Advanced Settings**

## 20.5. Selecting an algorithm for metamodel-based optimization

Optimization algorithms for metamodel-based optimization can be selected in the Algorithms panel in the GUI (see Figure 20-6).

The four core solvers that can be used for metamodel optimization are LFOPC, the Genetic Algorithm and Adaptive Simulated Annealing (ASA). Three hybrid algorithms may also be selected namely the Hybrid GA and Hybrid SA. The hybrid algorithms start with the GA and SA to find an approximate global optimum after which LFOPC is used to sharpen the solution. The solution to a hybrid algorithm will be at least as good as the one provided by the global optimizer (GA and SA). The syntax is as follows:

### Command file syntax:

---

```
Optimization algorithm [lfopc|genalg|hybrid ga|simulated
annealing|hybrid simulated annealing]
```

---

Hybrid Simulated Annealing is the default.

## 20.6. Setting parameters in the LFOPC algorithm

The values of the responses are scaled with the values at the initial design. The default parameters in LFOPC should therefore be adequate. Should the user have more stringent requirements, the following parameters may be set for LFOPC. These can also be set in the GUI.

**Table 20-2: LFOPC parameters and default values**

Item	Parameter	Default value	Remark
mu	Initial penalty value $\mu$	1.0E+2	
mumax	Maximum penalty value $\mu_{\max}$	1.0E+4	1
xtol	Convergence tolerance $\varepsilon_x$ on the step movement	1.0E-8	2
eg	Convergence tolerance $\varepsilon_f$ on the norm of the gradient	1.0E-5	2
delt	Maximum step size $\delta$	See remark	3
steps	Maximum number of steps per phase	1000	1
print	Printing interval	10	4

*Remarks:*

1. For higher accuracy, at the expense of economy, the value of  $\mu_{\max}$  can be increased. Since the optimization is done on approximate functions, economy is usually not important. The value of `steps` must then be increased as well.
2. The optimization is terminated when either of the convergence criteria becomes active that is when

$$\|\Delta(\mathbf{x})\| < \varepsilon_x$$

or

$$\|\nabla f(\mathbf{x})\| < \varepsilon_f$$

3. It is recommended that the maximum step size,  $\delta$ , be of the same order of magnitude as the “diameter of the region of interest”. To enable a small step size for the successive approximation scheme, the value of `delt` has been defaulted to  $\delta = 0.05\sqrt{\sum_{i=1}^n (range)^2}$ .
4. If `print = steps + 1`, then the printing is done on step 0 and exit only. The values of the design variables are suppressed on intermediate steps if `print < 0`.
5. The parameters can also be set in the GUI (Algorithms panel). See Figure 20-6.

**Command file syntax:**

---

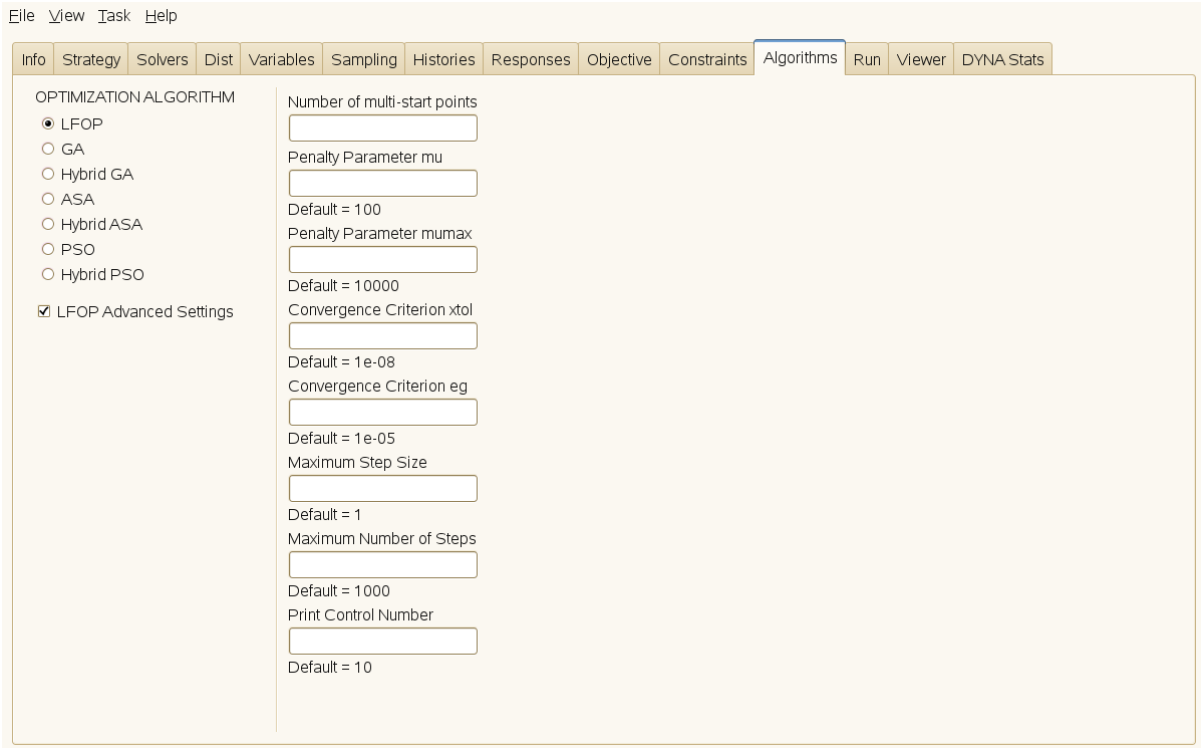
```
lfopt param parameter_identifier value
```

---

*Example:*

lfop param eg 1.0e-6

In the case of an infeasible optimization problem, the solver will find the most feasible design within the given region of interest bounded by the simple upper and lower bounds. A global solution is attempted by multiple starts from a set of random points.



**Figure 20-6: Selection of the LFOPC parameters**

## 20.7. Setting parameters in the genetic algorithm

The default parameters in the GA should be adequate for most problems. However, if the user needs to explore different methods, the following parameters may be set. These can also be set in the GUI (see Figure 20-7).

**Table 20-3: GA parameters and default values**

Item	Parameter	Default value	Type	Remark
popsize	Population size (always even)	30/100	Integer	1
generation	Number of generations	100/250	Integer	1
selection	Selection operator: Tournament, Roullette, SUS	TOURN		2
Tourn Size	Tournament size for tournament selection operator	2	Integer	2

Elitism	Switch elitism for single objective GA: ON/OFF	ON		
NumElites	Number of elites passed to next generation	2	Integer	
Encoding variable	Type of encoding for a variable: Binary=1, Real=2	2	Integer	2
Numbits variable	Number of bits assigned to a binary variable	15	Integer	2
Binary crossover type	Type of binary crossover: One point, Uniform	One Point		
Binary crossover probability	Binary crossover probability	1.00	Real	
Real crossover type	Type of real crossover: SBX, BLX	SBX		
Real crossover probability	Real crossover probability	1.00	Real	
BLX alpha param	Value of $\alpha$ for BLX operator	0.5	Real	
Real crossover distribution index	Distribution index for SBX crossover operator	10.0	Real	
Binary mutation probability	Mutation probability for binary mutation	1/number of binary digits	Real	
Real mutation probability	Mutation probability in real-space	1/number of real variables	Real	
Real mutation distribution index	Distribution index for mutation operator	10.0	Real	
MOEA TYPE	Multi-objective optimization algorithm: NSGA2, SPEA2	NSGA2		
Restart interval	Frequency of writing restart file. For multi-objective problems, this parameter governs the frequency of writing TradeOff files	10	Integer	

*Remarks:*

**Command file syntax:**

---

GA parameter parameter identifier value

---

*Example:*

GA parameter popsize 100

For direct GA, the default population size is 30 and number of generations is 100. For SRSM, the default population size is 100 and number of generations is 250.

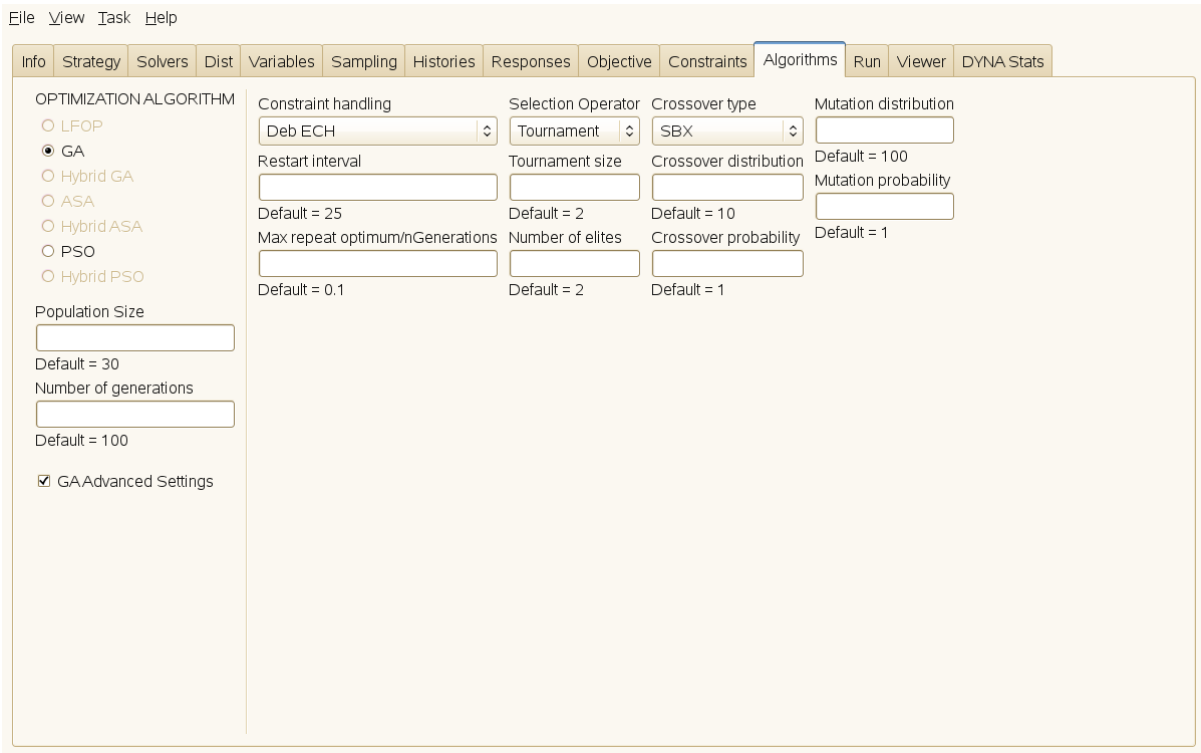


**Command file syntax:**

Encoding variable variable\_name value

*Example:*

Encoding variable 'x1' 1  
 Numbits variable 'x1' 20



*Figure 20-7: Selection of the GA parameters for creating a Pareto Optimal Frontier*

**20.8. Setting parameters in the simulated annealing algorithm**

The adaptive simulated annealing parameters can be modified in the command file manually.

*Table 20-4: ASA parameters and default values*

Item	Parameter	Default value	Type
Temperature ratio	Ratio of minimum and maximum temperature	1e-6	Real
Annealing scale	Annealing scale	1000	Integer
Function param ratio	Ratio of cost temperature ratio and parameter temperature ratio	1	Integer
Maximum simulation	Maximum number of function evaluations	10000	Integer

Temperature update interval	Number of function evaluations at some temperature	1	Integer
NumElites	Number of elites passed to next generation	2	Integer

**Command file syntax:**

---

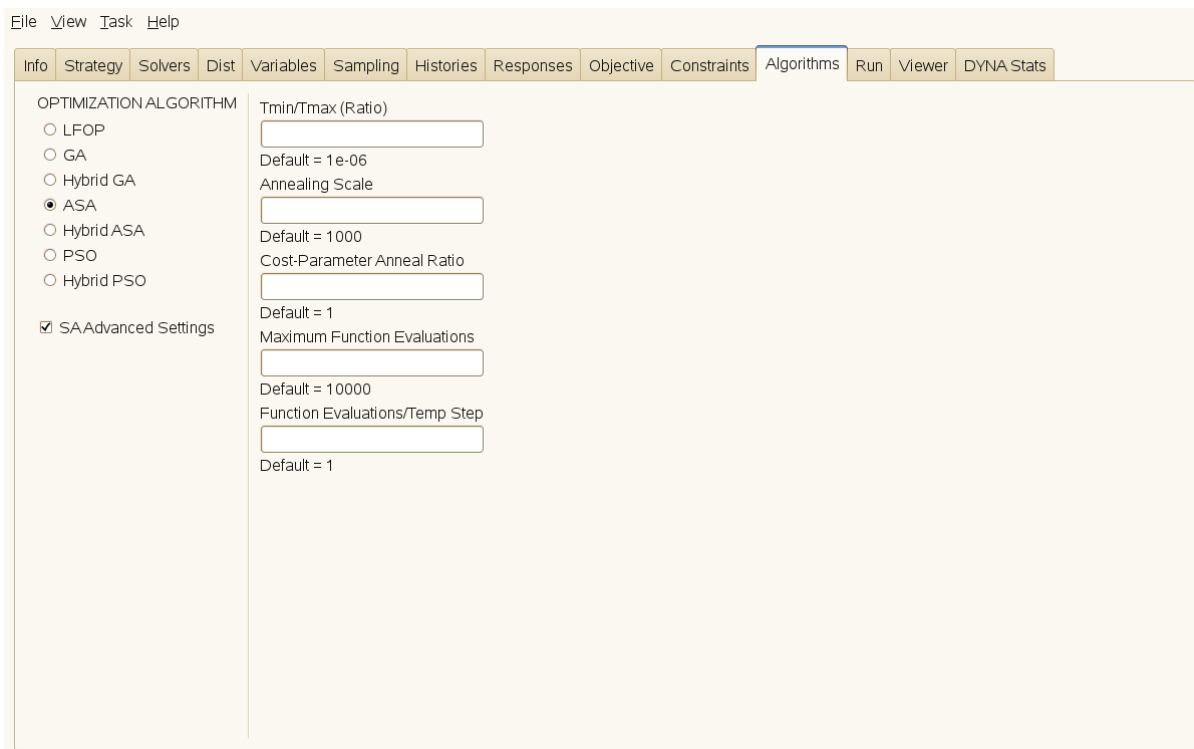
SA parameter identifier value

---

*Example:*

SA temperature ratio 1e-6

The parameters can also be set in the GUI (see Figure 20-8).



**Figure 20-8: Selection of the SA parameters**

## 20.9. Termination criterion for multi-objective optimizers

A few termination criteria are available for multi-objective optimizers. While the default selection is maximum number of function evaluations/generations, one can also use consolidation ratio or hypervolume based metrics to terminate the search as shown in Figure 20-9.

**Table 20-5: Termination criteria and default values**

Item	Parameter	Default	Type
stoppingtype	MOO performance metric*: Consolidation Ratio   Variable Consolidation Ratio   Hypervolume *No information needed for maximum function criterion	NONE	
Generation interval	Interval to calculate MOO performance metrics	10	Integer
Hypervolume deviation threshold	Threshold value for the change in normalized hypervolume	1.0e-4	Real
Consolidation ratio threshold ratio	Parameter F defining bound ( $CR_i/F$ ) on the variation in the consolidation ratio	5	Real
Consolidation ratio threshold	Threshold value of the consolidation ratio	0.8	Real

**Command file syntax:**

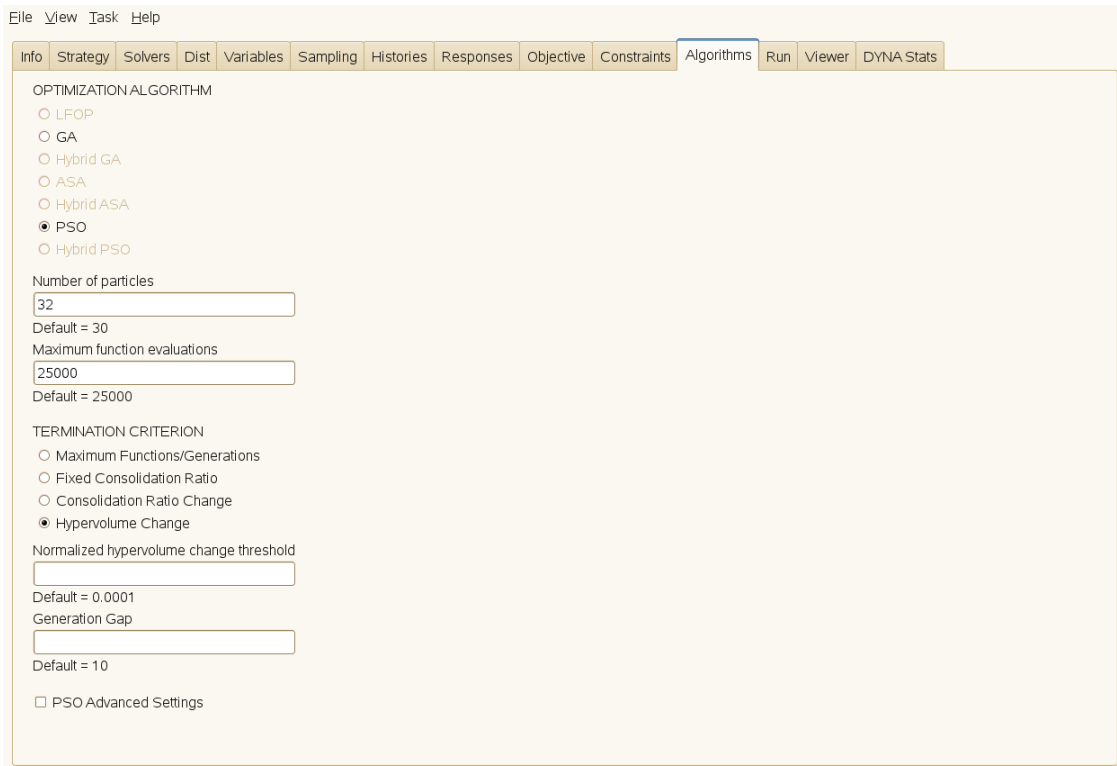
---

Multiobjective parameter\_identifier value

---

*Example:*

Multiobjective generation interval 5



**Figure 20-9: Termination criteria selection for multi-objective optimizers**

## 20.10. Verification runs

After the last full iteration a verification run of the predicted optimal design is executed. This run can also be omitted if the user is only interested in the prediction of the optimum using the metamodel.

**Command file syntax:**

---

```
iterate noverify
```

---

The verification run can also be omitted by setting a flag in the Run panel.

For multi-objective optimization problems, multiple verification runs can be done. A discrete Space Filling algorithm is used to select Pareto Optimal points which are evenly distributed in the design space.

**Command file syntax:**

---

```
verify number_of_design_points
```

---

The number of verification runs can be set in the GUI.



# 21. LS-DYNA Results Statistics

The statistics of the LS-DYNA results can be displayed on the FE model. The statistics of the LS-DYNA d3plot results and LS-OPT history data are computed by LS-OPT for viewing in LS-PREPOST. These statistics shows:

- The variation of the LS-DYNA results due to the variation of the design parameters.
- The variation of the LS-DYNA results due to bifurcations and other stochastic process events.

The d3plot results are computed and displayed for every node or element for every state in the d3plot database, while the history results are likewise computed and displayed for every timestep in the history.

A more complete list of the statistics that can be computed and visualized is:

1. Statistics of the **Monte Carlo** data from the LS-DYNA jobs. These are the data from the experimental designs used. If the experimental design was for a Monte Carlo analysis then the experimental design reflects the variation of the design variables, but if the experimental design was for creating a metamodel then the experimental design does not reflect the statistical variation of the design variables.
2. Statistics of the results considering the variation of the design variables using the approximations (**metamodels**) created from the LS-DYNA jobs. The distributions of the design variables and the metamodels are used to compute the variation of the responses. If distributions were not assigned to the design variables, the resulting variation will be zero. The metamodels allow the computations of the following:
  - The deterministic or parametric variation of the responses caused by the variation of the design variables.
  - Statistics of the residuals from the metamodels created from the LS-DYNA jobs. These residuals are used to find bifurcations in the structural behavior – the outliers comprise the displacement changes not associated with a design variable change. See Section 6.6 regarding the computation of outliers. This is the process variation is associated with structural effects such as bifurcations and not with changes in the design variable values.
  - The stochastic contribution of a variable can be investigated.
  - A probabilistic safety margin with respect to a bound on the LS-DYNA response can be plotted.
  - The LS-OPT histories of all the LS-DYNA runs can be plotted.

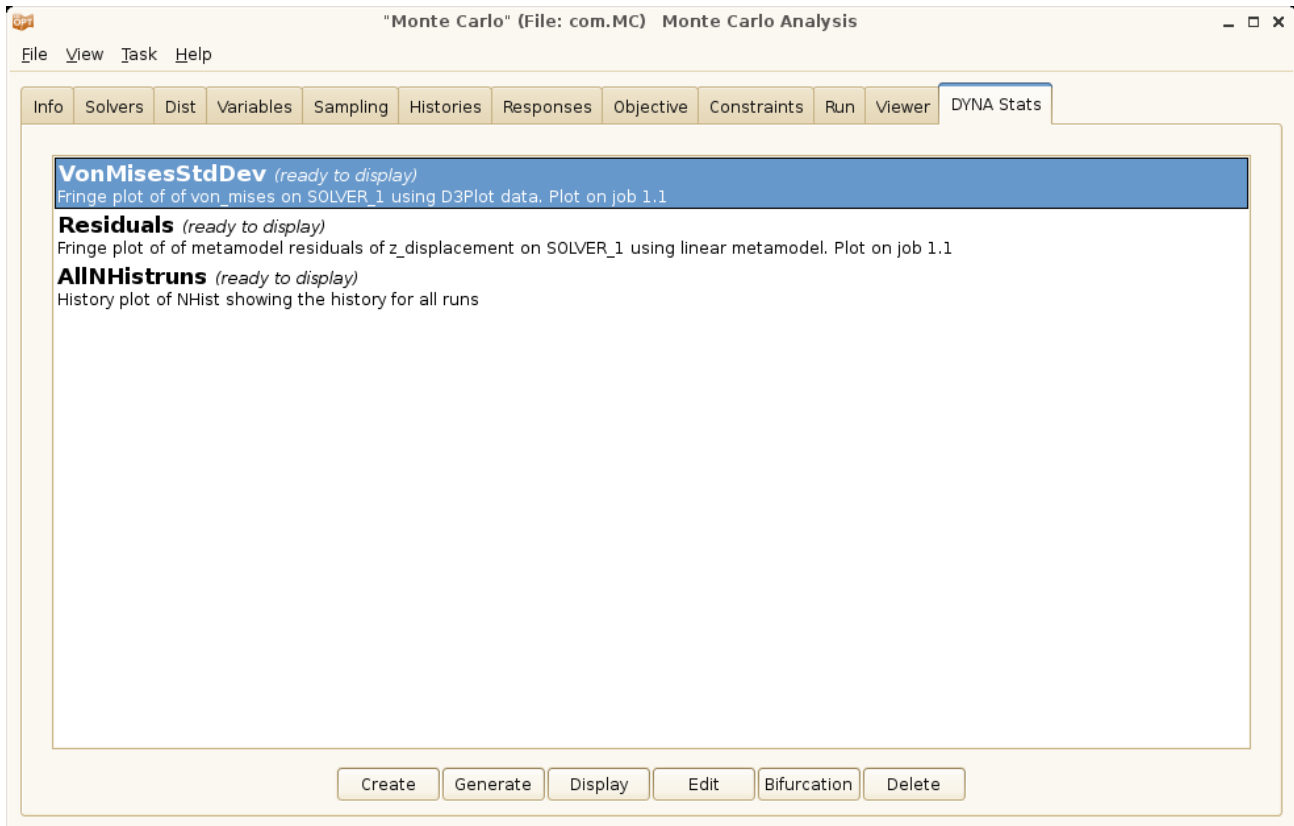
3. The correlation of d3plot results or histories with an LS-OPT response can be displayed. This can be used, for example, to identify the changes in displacements associated with noise in an LS-OPT response.

## 21.1. Working with the plots

Use the GUI panel shown in Figure 21-1 to work with the plots. Utilize the following actions:

- *Create* This creates a new plot. Note that this only creates the definition of the plot. The data for the must be generated before it can be displayed.
- *Generate* The data for a plot is generated. This is done only once per plot. More than one plot can be selected to be generated – there is no need to generate plots one-by-one.
- *Display* Plot previously created and generated can be displayed.
- *Edit* A plot can be edited or copied. This may require that the data be re-generated.
- *Bifurcation* A study can be investigated for bifurcations, and the bifurcation can be plotted.
- *Delete* A plot can be deleted.

The plot definitions are stored in a file which allows re-use of a methodology in different studies (see Section 21.13).



*Figure 21-1 Visualization of DYNASTATS results statistics. After a plot has been created using the plot creation wizard, the data for the plot must be generated by running LS-OPT, following which the plot can be displayed in LS-PREPOST. An existing plot can be edited, or a bifurcation in the plot can be investigated, or the plot can be deleted.*

## 21.2. Monte Carlo

The statistics of the responses from a Monte Carlo procedure can be computed. The task will calculate:

1. Statistics of the response
  - Mean value of the response
  - Standard deviation of the response
  - Range of the response (maximum minus the minimum value)
  - Maximum value of the response
  - Minimum value of the response
  - ID of the LS-DYNA job where the maximum value occurred. This can be used to indentify the jobs likely to contain a different bifurcation.
  - ID of the LS-DYNA job where the minimum value occurred. This can be used to indentify the jobs likely to contain a different bifurcation.

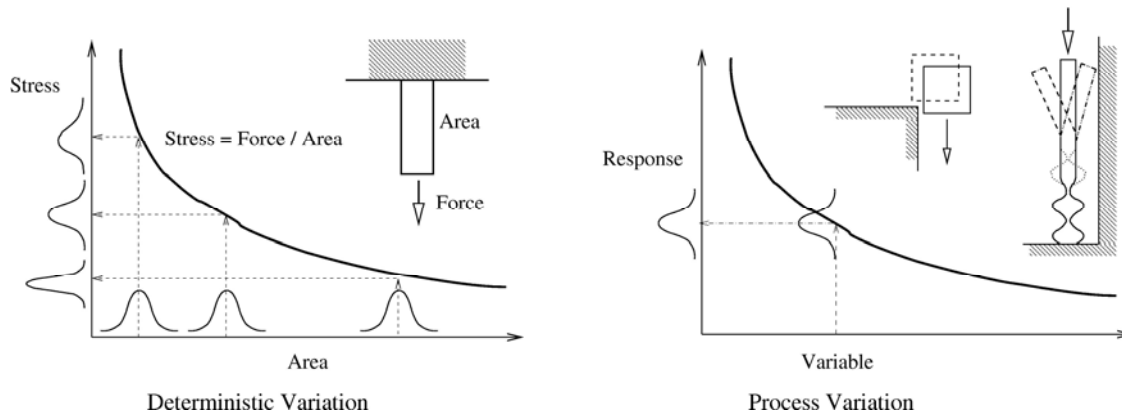


2. The margin of safety (constraint margin) considering (i) a given bound on the response and (ii) the variation of the response as computed using the Monte Carlo analysis (see also Section 21.7).

### 21.3. Metamodels and residuals

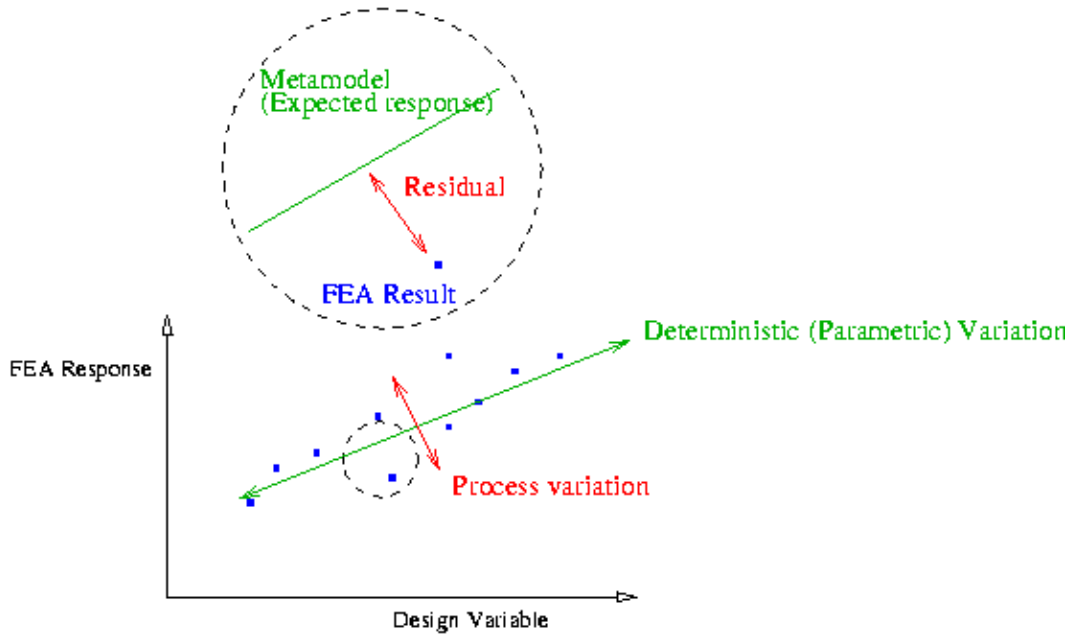
Metamodels (approximations) can be used to predict the statistics of the responses. These metamodels (approximations) will be computed for all results for all nodes for all time steps.

The metamodels are also useful for separating deterministic variation, caused by the variation of the design variables, from the process variation. The two types of variation are as shown in Figure 21-2.



**Figure 21-2** Different types of variation that can occur in a structure. The deterministic variation, predicted using the metamodel, is due to changes in the design variable values. The process variation, not associated with change in the design variable values, shows up in the residuals of the metamodel fit.

Metamodels are able to distinguish the process variation because, as shown in Figure 21-3, a metamodel can only predict the effect of the design variables. Process variation, not predictable by the design variables, becomes residuals.



**Figure 21-3** *Metamodels can be used to distinguish between changes in the results due to the design variable changes and changes due to bifurcations.*

The metamodel task will calculate:

1. Statistics of the response due to all the variables using the metamodel
  - Mean value of the response
  - Standard deviation of the response
  - Range (four standard deviations)
  - Maximum value (mean plus two standard deviations)
  - Minimum value (mean minus two standard deviations)
2. Statistics of the residuals
  - Mean value of the residuals (always zero)
  - Standard deviation of the residuals
  - Range of the residuals (maximum minus the minimum value)
  - Maximum value of the residuals
  - Minimum value of the residuals
  - ID of the LS-DYNA job where the maximum residual occurred. This can be used to indentify the jobs likely to contain a different bifurcation.
  - ID of the LS-DYNA job where the minimum residual occurred. This can be used to indentify the jobs likely to contain a different bifurcation.
3. Stochastic contribution of each individual variable

4. The margin of safety (constraint margin) considering (i) a given bound on the response and (ii) the variation of the response as computed using the metamodel (see also Section 21.7).
5. All the computations as specified for the Monte Carlo procedure. The data required for this computation is read in for the metamodel computations, so very little time is expended computed these results as well.

The standard deviation of the variation caused by the design variables are computed using the metamodel as described in Section 6.7. The maximum, minimum, and range are computed using the mean value plus/minus two standard deviations. The *Max Job ID* and *Min Job ID* are not meaningful for the metamodel results.

The residuals are computed as the difference between the values computed using FEA and the values predicted using the metamodel (see Section 6.6 for more details).

A linear or a quadratic response surface can be used.

The metamodel processing speed is approximately  $10^5 - 10^6$  finite element nodes a second, where the total number of nodes to be processed is the number of nodes in the model times the number of states times the number of jobs. FLD computations, which require the computation of the principle strains, can be a factor of five slower than computations using the nodal displacements. The overall speed is dominated by the time required to read the d3plot files from disk, which means accessing files over a network will be slow.

## 21.4. Monte Carlo and metamodel analysis commands

This section gives the commands required for the computation of the statistics from a Monte Carlo or a metamodel based set of LS-DYNA results.

Either the LS-DYNA d3plot results or LS-OPT history results can be analyzed. The resulting output can be viewed in LS-PREPOST. The results will be in the solver directory with extensions of *.statdb* and *.history*.

The statistics are computed for a single solver and a single iteration.

### Command file syntax:

---

```
dynastat solver `case_name`  
dynastat iteration interation_number  
dynastat order approx_order  
analyze dynastat  
analyze dynastat d3plot `result_type` `component`
```

---

---

```
analyze dynastat d3plot `FLD' `fld_component' parameters fld_t
fld n
analyze dynastat d3plot `FLD' `fld_component' fld_curve_id
analyze dynastat history `history_name'
```

---

*Example:*

```
dynastat order linear
```

Item	Description	Default
<i>case_name</i>	Name of analysis case	The first or only case specified
<i>iteration_number</i>	Iteration number	1
<i>approx_order</i>	linear   quadratic	Do not use a metamodel
<i>result_type</i>	The available result types are listed Appendix A	
<i>component</i>	The available components are listed Appendix A	
<i>fld t</i>	FLD curve <i>t</i> coefficient	
<i>fld n</i>	FLD curve <i>n</i> coefficient	
<i>fld_curve_id</i>	ID in the LS-DYNA file of the FLD curve to be used	
<i>history_name</i>	Name of LS-OPT history	

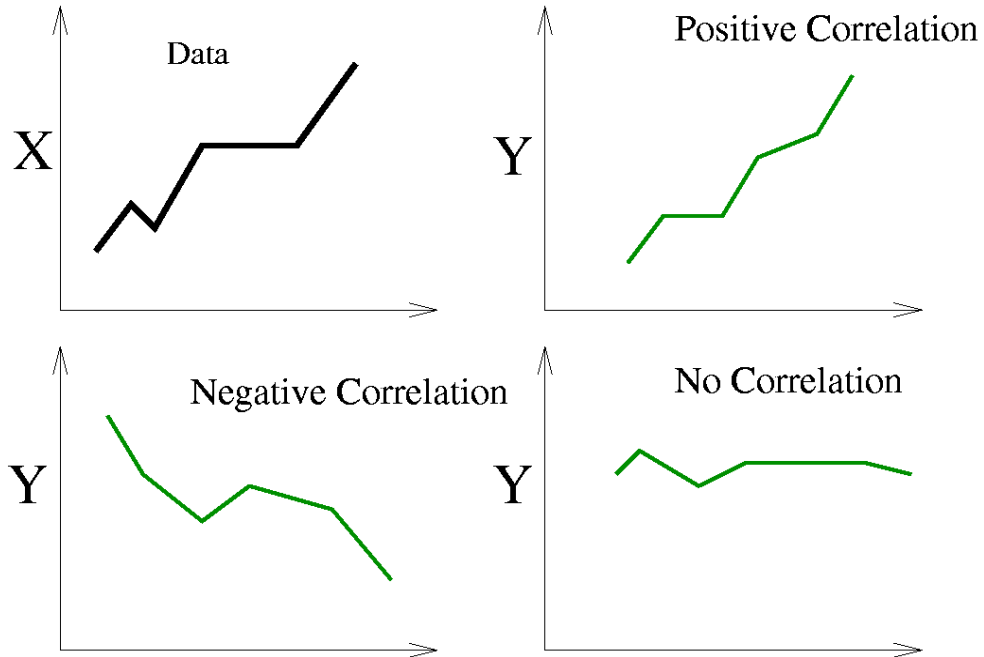
*Example:*

```
$ analyze displacement using a metamodel
dynastat solver `CRASH'
dynastat iteration 1
analyze dynastat
dynastat order linear
$
$ analyze history using a metamodel
dynastat solver `CRASH'
dynastat iteration 1
dynastat order linear
analyze dynastat history `nHist'
```

## 21.5. Correlation

### 21.5.1. Correlation of fringe plots or histories with responses

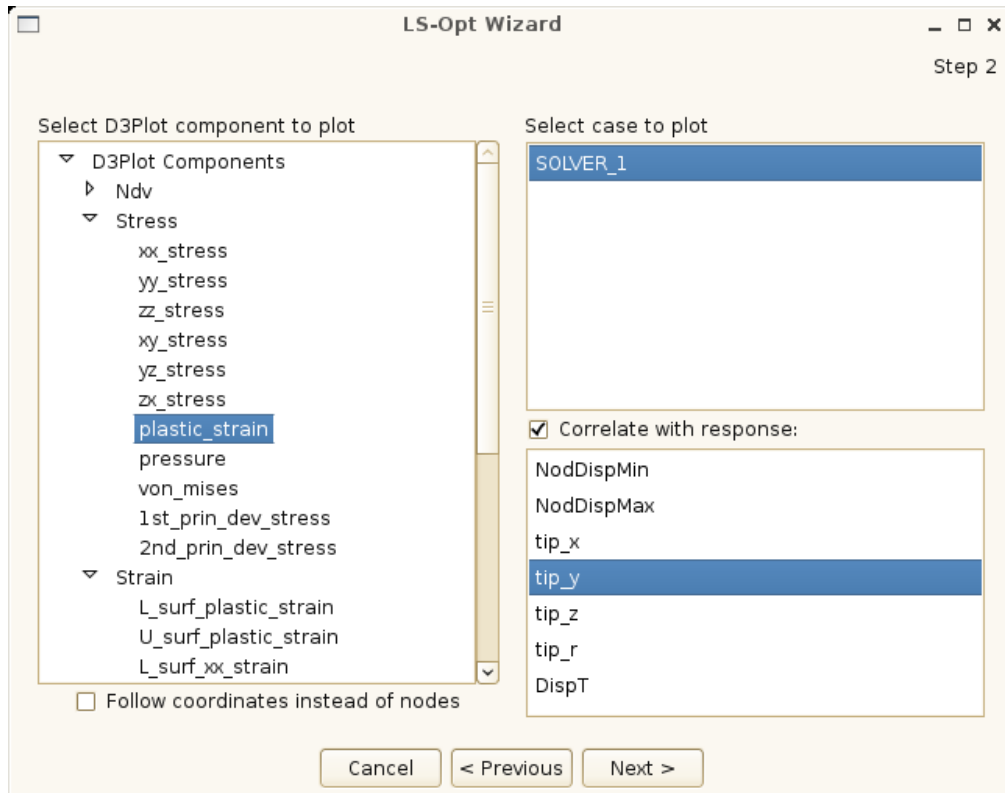
The correlation of the LS-DYNA results or LS-OPT histories with a response can be computed. This quantity indicates whether the changes in the responses are associated with the changes in the displacement or history. Figure 21-4 shows examples of a positive, a negative, and a lack of correlation.



**Figure 21-4** Correlation between  $X$ , shown in the upper left corner, and different responses  $Y$ . Different responses  $Y$  with a positive, a negative, and no correlation are shown.

If not enough FE evaluations were conducted, the resulting fringe plot can be visually noisy. Thirty or more FE evaluations may be required.

Note that the correlation of history is with respect to a response at a single time instance.



*Figure 21-5 Viewing the correlation between an LS-DYNA response and an LS-OPT response. Additionally, the correlation between an LS-OPT history and an LS-OPT response can also be viewed.*

**Command file syntax:**

---

```
dynastat correlation response 'name'
```

---

Item	Description
<i>name</i>	Name of response or composite

*Example:*  
 dynastat correlation response 'node\_max'

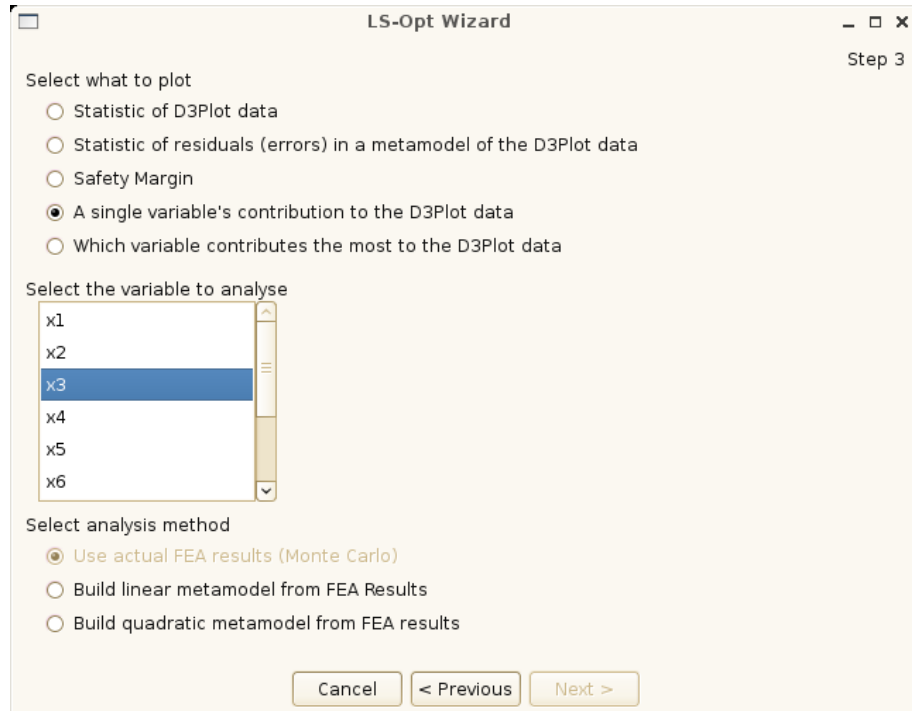
**21.5.2. Correlation between variables**

If correlation between variables are specified as described in Section 12.3.4, this will be handled automatically for Monte Carlo results as well as results computed using a linear metamodel. Quadratic metamodels will generate an error message.

## 21.6. Stochastic contribution of a variable (Design sensitivity analysis)

The contribution of each design variable to the variation of the nodal response can also be plotted on the model. These results are computed as described in Section 6.7.

The most important variable, or rather the variable responsible for the most variation of the response, can be plotted on the model. Actually, only the index of the variable is displayed on the model. This index is the same as in the list of variables as shown in the LS-DYNA results statistics GUI.

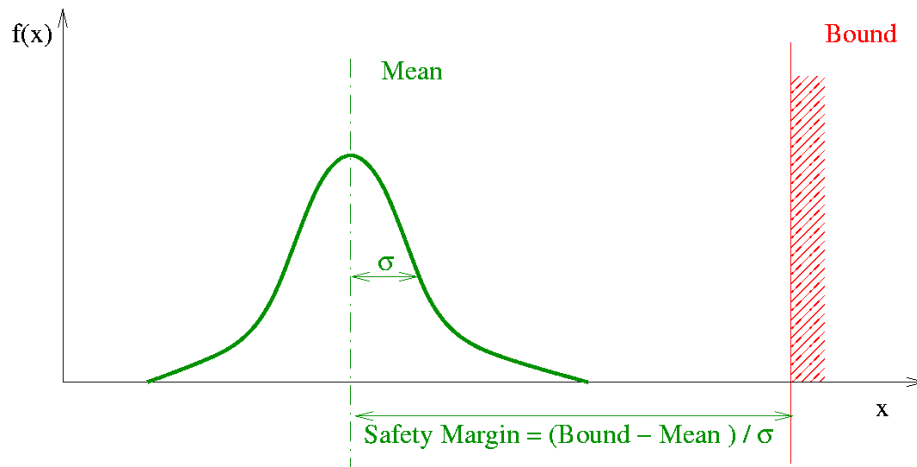


*Figure 21-6 Viewing the stochastic contribution of a single variable.*

## 21.7. Safety margin

The safety margin as shown in Figure 21-7 can be displayed in three ways:

1. The safety margin — the difference between the bound and mean,
2. The safety margin measured (scaled) in standard deviations (sigmas), and
3. The probability of exceeding the bound.



**Figure 21-7** The safety margin is the difference, measured in standard deviations, between the mean response and the constraint bound on the response.

The bound must therefore be specified when the statistics are computed as shown in Figure 21-8. Obtaining the safety margin for a different bound requires the generation of a new plot.

The probability of exceeding the bound is computed using the FOSM method (see Section 6.4.4) using the normal distribution together with the safety margin measured in standard deviations (sigmas). The computation is therefore done in the six-sigma sense interpretation — the number of sigmas (standard deviations) is the unit of measure. For a Monte Carlo computation of the probability is desired, then it must be computed using a response in viewer; if this response was not defined originally then it must be extracted from the d3plot database: first defining a d3plot response, do a repair/extract, and use Viewer.



Step 3

Select what to plot

- Statistic of D3Plot data
- Statistic of residuals (errors) in a metamodel of the D3Plot data
- Safety Margin
- A single variable's contribution to the D3Plot data
- Which variable contributes the most to the D3Plot data

Enter desired safety margin  bound:

Select value to plot

- Safety Margin
- Safety Margin scaled with response standard deviation
- Probability of Failure

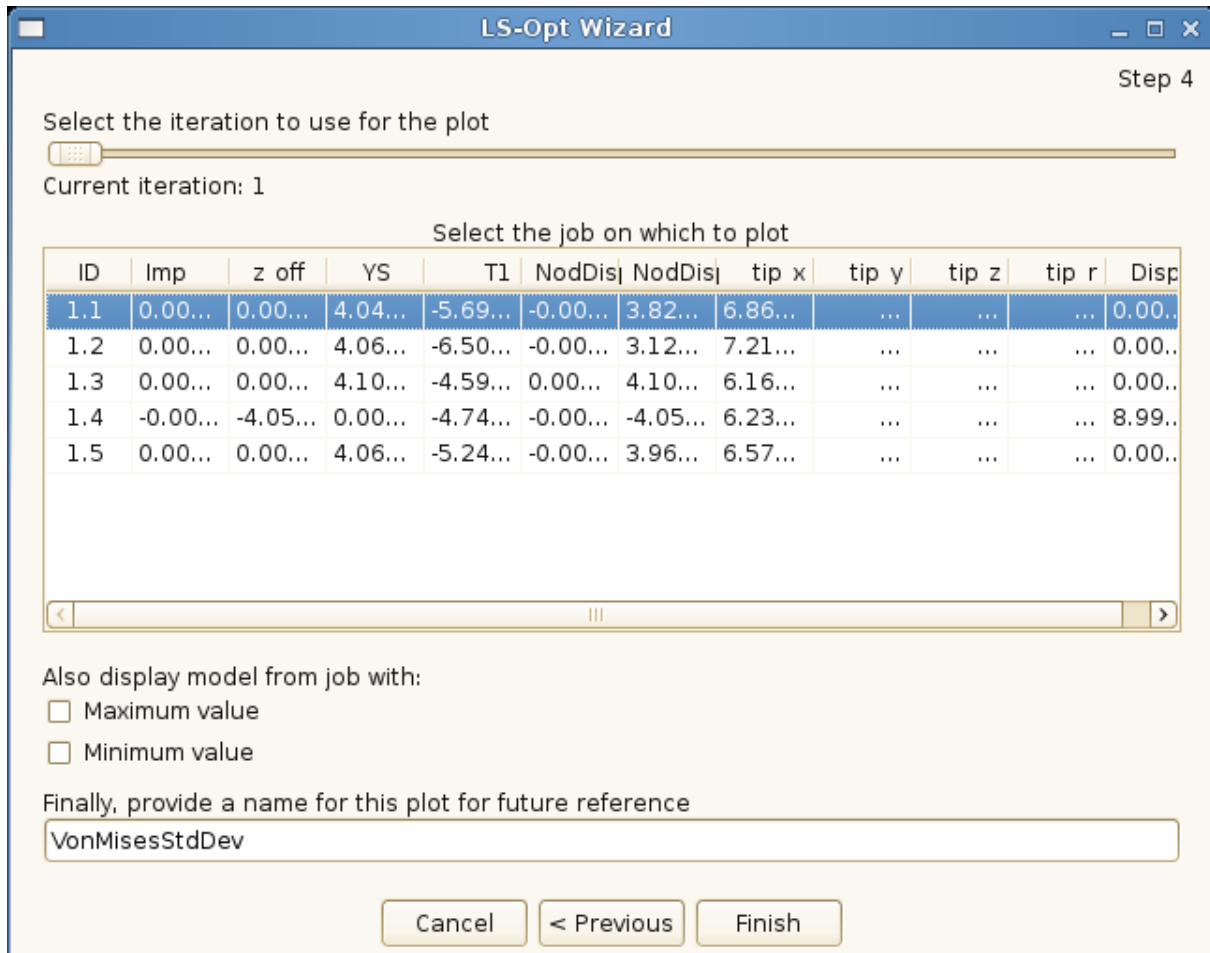
Select analysis method

- Use actual FEA results (Monte Carlo)
- Build linear metamodel from FEA Results
- Build quadratic metamodel from FEA results

*Figure 21-8 Plotting a safety margin or the probability of failure requires that the bound must be specified.*

## 21.8. Visualization in LS-PREPOST

The user can select the LS-PREPOST plot details in LS-OPT (Figure 21-9). The GUI options will reflect whether displacements or history data is being investigated and whether coefficient of correlation results are requested.



**Figure 21-9** The statistics viewing options. The statistics will be shown in LS-PREPOST using the FE model from the LS-DYNA job specified using the Job field. The FE models of the jobs containing the maximum and minimum values can be overlayed in order to identify bifurcations as described in Section 21.10.

The *Job Index* field specifies the FE model used for the display of the results. Additionally, the FE models containing the maximum and the minimum results can be overlayed in order to spot bifurcations as described in a later section.

## 21.9. Viewing LS-OPT histories

The LS-OPT histories for all the LS-DYNA run can be viewed simultaneously. See Figure 21-12 for an example.

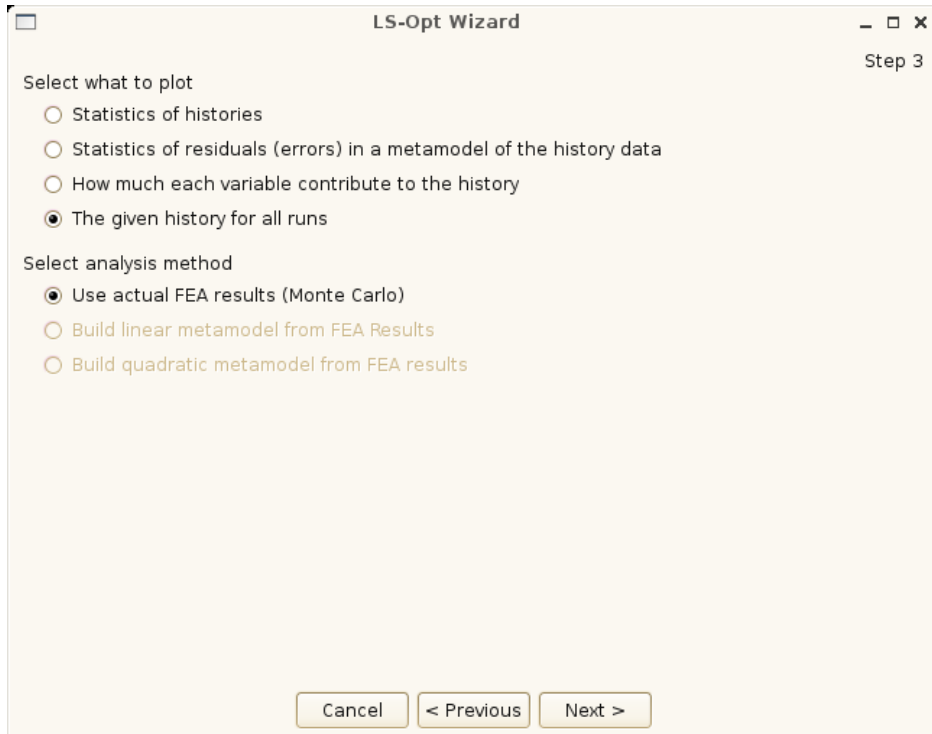


Figure 21-10 Viewing all the LS-OPT histories.

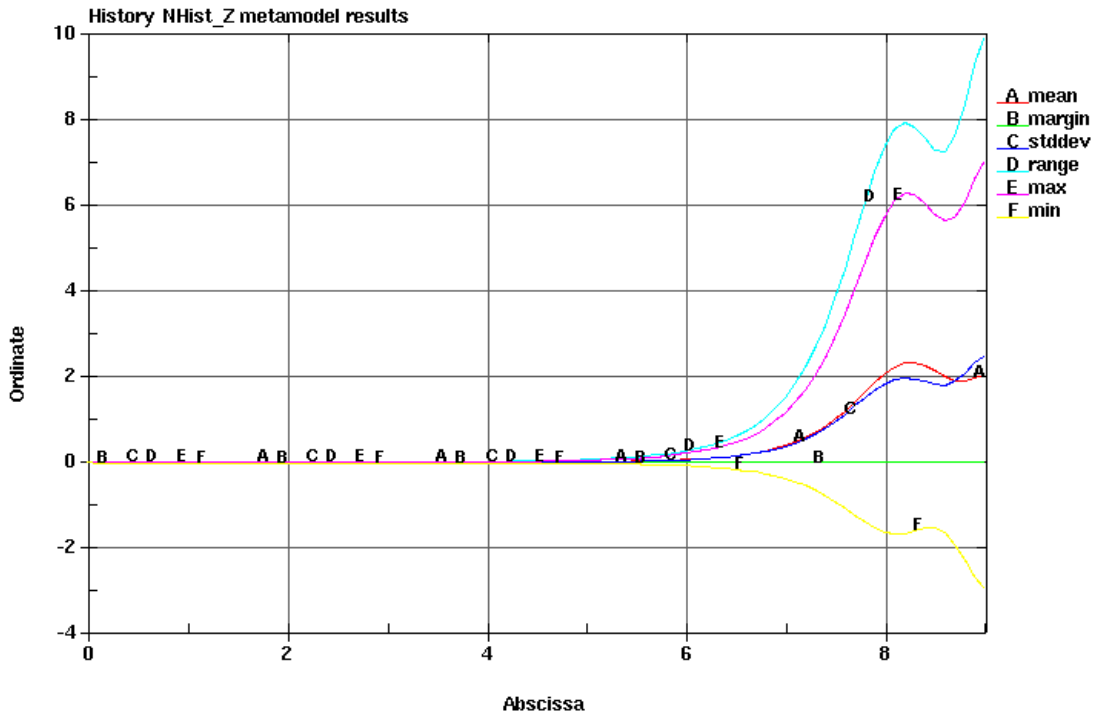
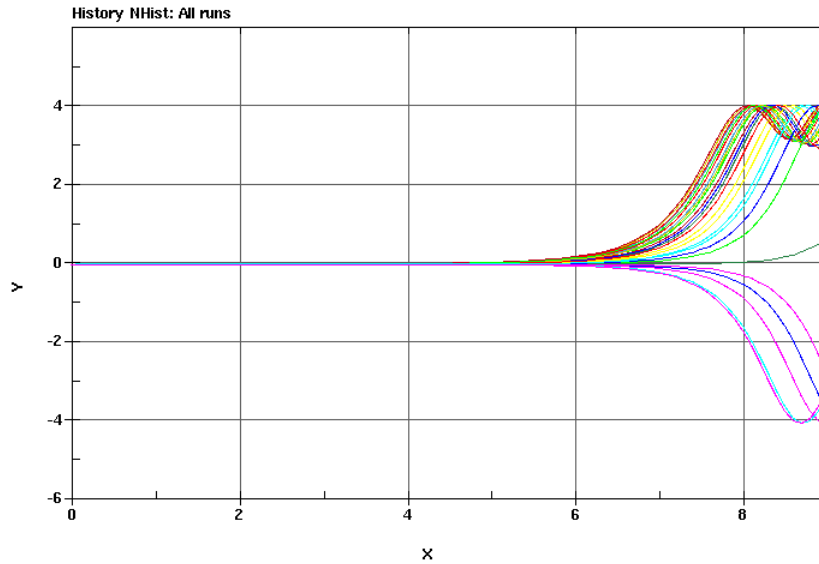


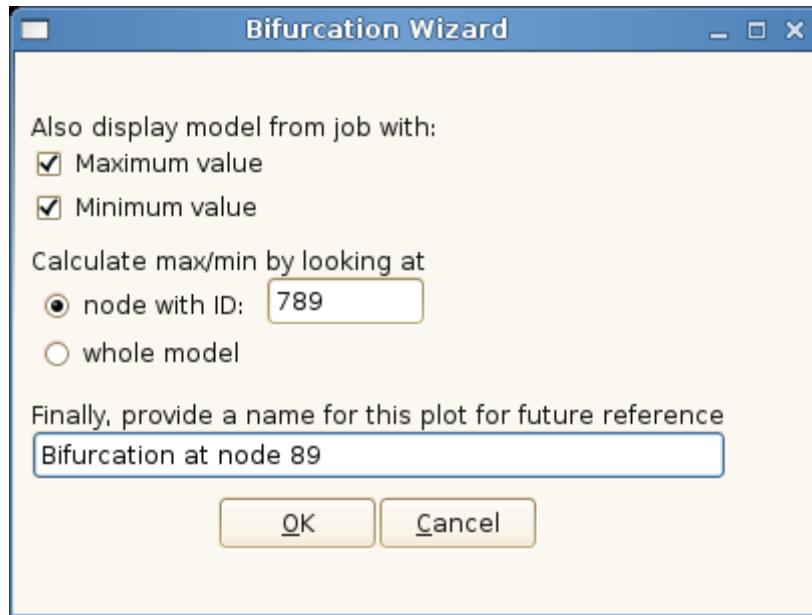
Figure 21-11 Statistics of an LS-OPT history.



*Figure 21-12 The LS-OPT histories of all the LS-DYNA run can be viewed simultaneously.*

## 21.10. Bifurcation investigations

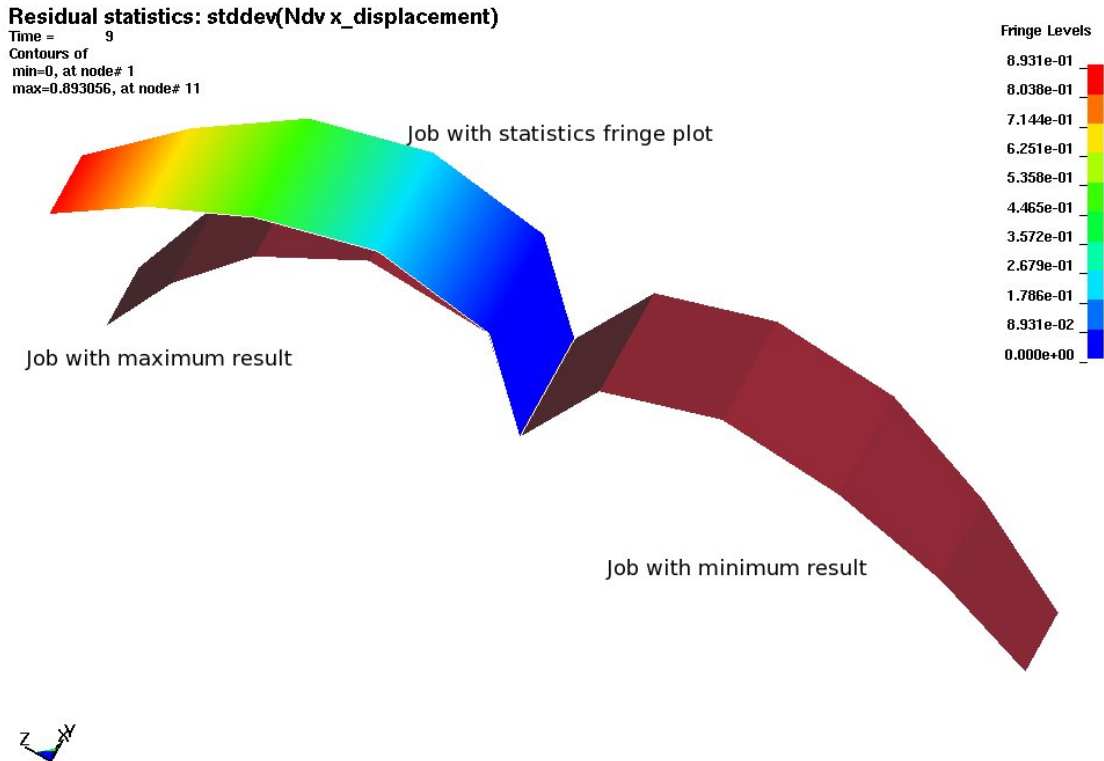
The residuals plots are useful for finding bifurcations. The standard deviation (or range) of the residuals indicate regions where the changes in displacements are not explained by changes in the design variable values — it is therefore a plot of the unexpected displacements or ‘surprise factor’. The plots from a Monte Carlo analysis can also be used to find bifurcations similarly to the residuals from a metamodel-based Monte Carlo analysis.



*Figure 21-13 Bifurcation options. The bifurcation is found by superimposing the FE models containing the maximum and minimum results. The specification of a node ID associated with the bifurcation may be required if the extreme values in the model are not caused by the bifurcation.*

### 21.10.1. Automatic detection

Automatic detection of the LS-DYNA jobs containing the minimum and maximum outlier can be done as shown in Figure 21-9. The GUI the user must select (i) overlay of the FE models containing the maximum and minimum results and (ii) whether the global minimum or the minimum at specific node must be used. Viewing the maximum and minimum job simultaneously allows the bifurcation to be identified. See Figure 21-9 for an example of the resulting LS-PREPOST plot.



**Figure 21-14** Viewing a bifurcation. The structure is a plate that can buckle either left or right. Three FE models are shown, and the two distinctly different solution modes are clearly visible. The creation and display of the plot containing all three models are automated in LS-OPT.

### 21.10.2. Manual detection

The steps for manual detection are:

1. Plot displacement magnitude outlier *Range* to identify location in FE model where the bifurcation occurred.
2. Identify job in which maximum value occurred using a *Max Job ID* plot
3. Identify job in which minimum value occurred using a *Min Job ID* plot
4. View the location in model for the jobs having the minimum and maximum value.

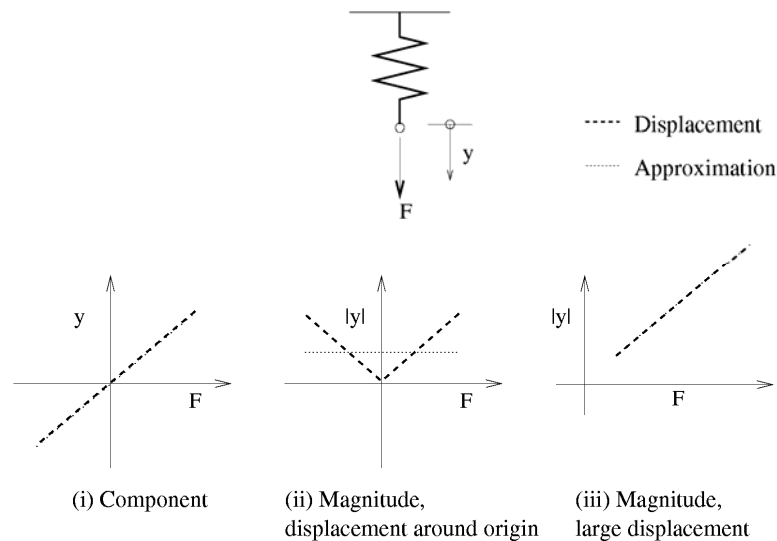
Recommendations:

- Engineering knowledge of the structure is important.
- Look at the  $x$ ,  $y$ , and  $z$  components in addition to the displacement magnitude to understand in which direction the bifurcation occurred; most bifurcations are actually best identified considering a displacement component.
- The history results may be useful to find the time at which a bifurcation occurred.
- The correlation between a response and displacements (or histories) indicates if variation of the displacement is linked to variation of the response.

- Look at all of the states in the d3plot database; the bifurcation may be clearer at an earlier analysis time.

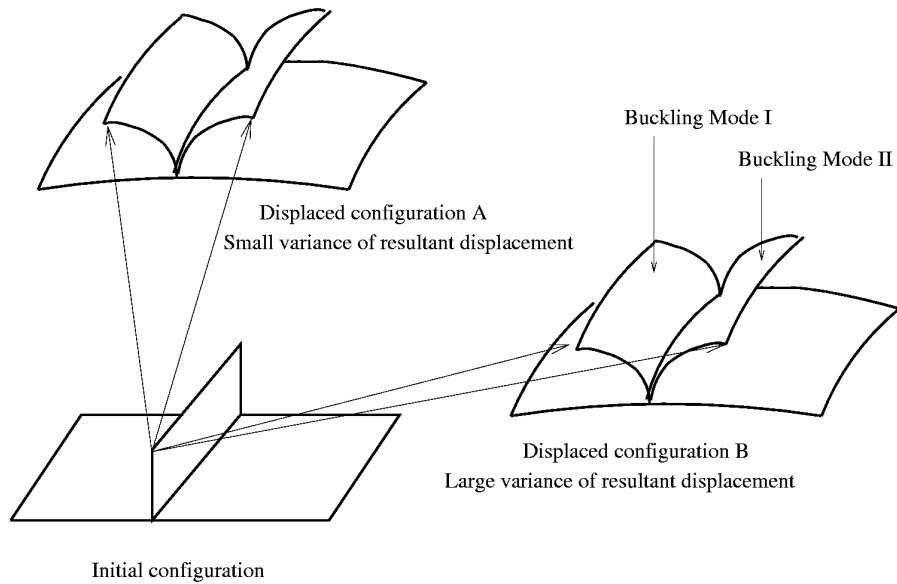
### 21.11. Displacement magnitude issues\*

Approximation of the displacement magnitudes (resultants) introduces some special cases. The magnitude is defined as the square root of a sum of squares, which is difficult to approximate around the origin, especially using linear approximations. Figure 21-15 illustrates. The x, y, and z displacement components do not suffer from this problem.



**Figure 21-15 Displacement approximation scenarios. The displacement magnitude, being always larger than zero, cannot be approximated accurately around the origin if some of the displacement components can have a negative value.**

Unexpected results may occur even if the displacement magnitude is approximated correctly. The displacement magnitude is always a positive quantity, which, in addition to the fitting problems, can also cause problems when computing the coefficient of correlation with a response quantity. Figure 21-16 illustrates two buckling modes of a flange evaluated at two locations in space. The displacement magnitude variance differs for the two locations though the buckling modes are similar. The variance of the displacement magnitude will therefore be smaller than what would be found considering the components. Considering a displacement component will cure this problem, but a displacement component aligned with the required direction may not always exist.



**Figure 21-16** The displacement magnitude can depend on the alignment of the flange with the axis. The buckling will be difficult to spot if it is aligned with the position of the axis. For configuration A, the two vectors have nearly the same length, while for configuration B, they clearly have different lengths.

Recommendations:

- Use the x, y, and z displacement components.

## 21.12. Metalforming options

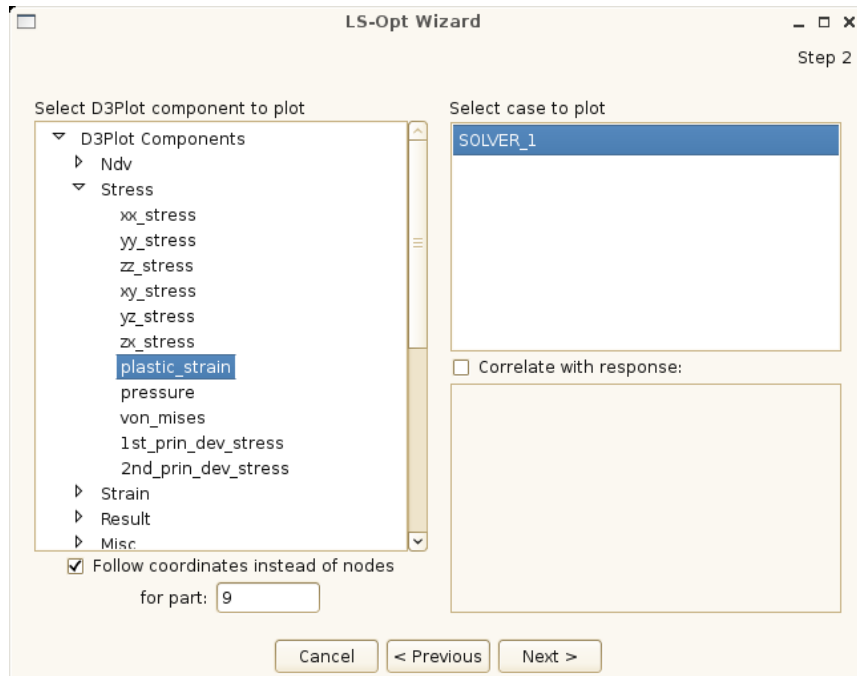
Metalforming has some special requirements. It is possible to:

1. Map the results from each iteration to the mesh of the base design. The results will be computed at a specific spatial location instead of a node (Eulerian system). This is required in metalforming because:
  - The adaptivity will result in the different iterations having different meshes.
  - It is more natural in metalforming to consider the results at a specific geometric location than at a specific node.

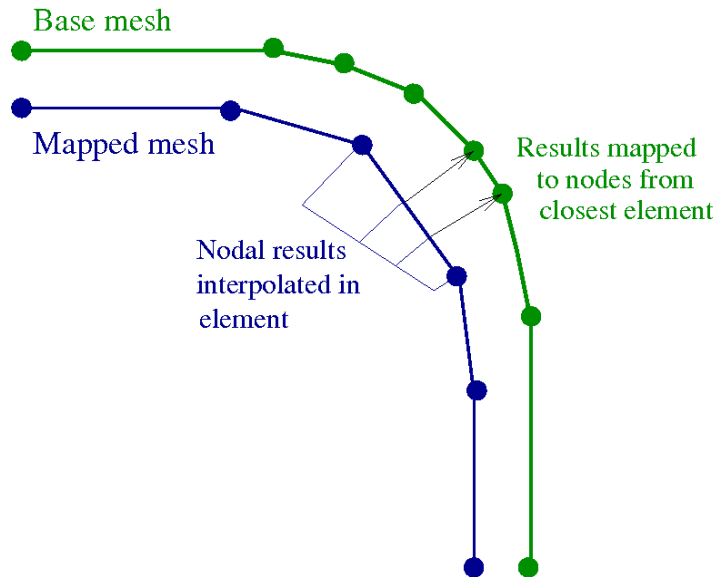
This is done only for the work piece. This part must therefore be specified in the LS-OPT input. More detail is shown in Figure 21-17, Figure 21-18, and Figure 21-19.

2. Specify the FLC curve to be used in the computation of the FLD responses. This can be done by either specifying the number of a curve in the LS-DYNA input deck or using two parameters similar to that being used in LS-PREPOST.

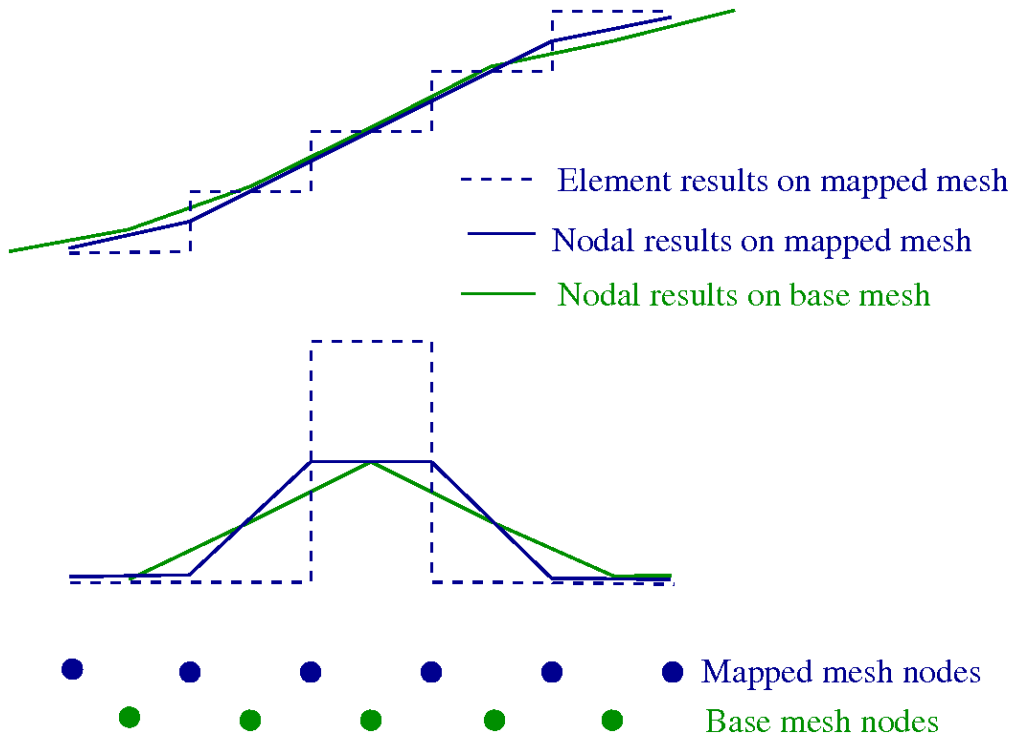




*Figure 21-17 For metal forming specify that the coordinates instead of the nodes must be followed and specify the part (blank) for which the results must be mapped.*



*Figure 21-18 Interpolation of metal forming results.*



*Figure 21-19 Accuracy of of the mapping operation for element results is shown for two cases. For each case the results are shown as the element centroid results for the original mapped mesh, the element results averaged at the nodes for the original mapped mesh, and the results mapped to the nodes of the base mesh. For the first case it can be seen that the mapping accuracy is good if the mesh is sufficiently fine to consider smoothly varying results. The second case, which occur when yielding occurs in a single element, indicates a loss of information. But for this second case, the exact numerical value of the original results is not considered very accurate, so we can consider the mapped results as sufficient as long as they conserve the prediction of failure. For the second case the numerical values are mesh-dependent, so the prediction of failure is the quantity that should be mapped to another mesh.*

**Command file syntax:**

---

```

dynastat map part
analyze dynastat d3plot 'FLD' 'fld_component' parameters fld_t
fld n
analyze dynastat d3plot 'FLD' 'fld_component' fld_curve_id
    
```

---

Item	Description
<i>part</i>	ID of part to be mapped
<i>fld t</i>	FLD curve <i>t</i> coefficient
<i>fld n</i>	FLD curve <i>n</i> coefficient
<i>fld_curve_id</i>	ID in the LS-DYNA file of the FLD curve to be used

*Example:*

```
dynastat map 8  
analyze dynastat 'FLD' 'lower_eps1/fldc' parameters 0.8 0.21
```

### **21.13. Re-use and persistence of an evaluation methodology\***

The definitions of the plots are saved in a file named *dynastatplots.xml*. Copy this file to the directory where you want to re-use the definitions. The plots will be available when you restart the LS-OPT gui. The plots will have to be re-generated though; note that you can select all of the plots when you generate plots – there is no need to generate plots one-by-one.

# 22. Example Problems

## 22.1. Two-bar truss (2 variables)

This example has the following features:

- A user-defined solver is used.
- Extraction is performed using user-defined scripts.
- First- and second-order response surface approximations are compared.
- The effect of subregion size is investigated.
- A trade-off study is performed.

The design optimization process is automated.

### 22.1.1. Description of problem

This example problem as shown in Figure 22-1 has one geometric and one element sizing variable.

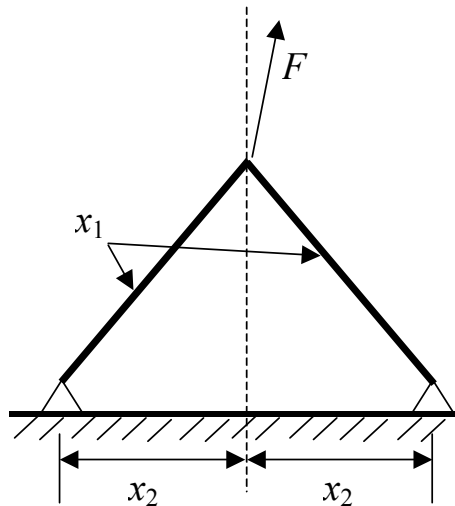


Figure 22-1: The two-bar truss example

The problem is statically determinate. The forces on the members depend only on the geometric variable.

Only one load case is considered:  $F = (F_x, F_y) = (24.8kN, 198.4kN)$ .

There are two design variables:  $x_1$  the cross-sectional area of the bars, and  $x_2$  half of the distance ( $m$ ) between the supported nodes. The lower bounds on the variables are  $0.2cm^2$  and  $0.1m$ , respectively. The upper bounds on the variables are  $4.0cm^2$  and  $1.6m$ , respectively.

The objective function is the weight of the structure.

$$f(x) = C_1 x_1 \sqrt{1 + x_2^2} \quad (22-1)$$

The stresses in the members are constrained to be less than 100 MPa.

$$\sigma_1(x) = C_2 \sqrt{1 + x_2^2} \left( \frac{8}{x_1} + \frac{1}{x_1 x_2} \right) \leq 1 \quad (22-2)$$

$$\sigma_2(x) = C_2 \sqrt{1 + x_2^2} \left( \frac{8}{x_1} - \frac{1}{x_1 x_2} \right) \leq 1 \quad (22-3)$$

where  $C_1 = 1.0$  and  $C_2 = 0.124$ .

Only the first stress constraint is considered since it will always have the larger value.

The C language is used for the simulation program. The following two programs simulate the weight response and stress response respectively.

#### **gw.c**

```
#include <stdlib.h>
#include <stdio.h>
#include <math.h>

#define NUMVAR 2

main (int argc, char *argv[])
{
  int i, flag;
  double x[NUMVAR], val;

  for (i=0; i<NUMVAR; i++) {
    flag = sscanf (argv[i+1], "%lf", &x[i]);
    if (flag != 1) {
      printf ("Error in calculation of Objective Function\n");
      exit (1);
    }
  }
}
```

```

    val = x[0] * sqrt(1 + x[1]*x[1]);

    printf ("%lf\n", val);
    fprintf (stderr, "N o r m a l\n");

    exit (0);
}

```

**gs.c**

```

#include <stdlib.h>
#include <stdio.h>
#include <math.h>

#define NUMVAR 2

main (int argc, char *argv[])
{
    int i, flag;
    double x[NUMVAR], val;
    double x2;

    for (i=0; i<NUMVAR; i++) {
        flag = sscanf (argv[i+1], "%lf", &x[i]);
        if (flag != 1) {
            printf ("Error in calculation of constraint1\n");
            exit (1);
        }
    }
    x2 = 1 + x[1]*x[1];
    val = 0.124 * sqrt (x2) * (8/x[0] + 1/x[0]/x[1]);

    printf ("%lf\n", val);
    fprintf (stderr, "N o r m a l\n");

    exit (0);
}

```

The UNIX script program `2bar_com` runs the C-programs `gw` and `gss` using the design variable file `XPoint` which is resident in each run directory, as input. For practical purposes, `2bar_com`, `gw` and `gs` have been placed in a directory above the working directory (or three directories above the run directory). Hence the references `../../../../2bar_com`, `../../../../gw`, etc. in the LS-OPT input file.

Note the output of the string "N o r m a l" so that the completion status may be recognized.

**2bar\_com:**

```
../../../../gw `cat XPoint` >wt; ../../../../gss `cat XPoint` >str
```

The UNIX extraction scripts `get_wt` and `get_str` are defined as user interfaces:

**get\_wt:**

```
cat wt
```

**get\_str:**

```
cat str
```

In Sections 22.1.2 to 22.1.4, a typical semi-automated optimization procedure is illustrated. Section 22.1.5 shows how a trade-off study can be conducted, while the last subsection 22.1.6 shows how an automated procedure can be specified for this example problem.

### 22.1.2. A first approximation using linear response surfaces

The first iteration is chosen to be linear. The input file for LS-OPT given below. The initial design is located at  $\mathbf{x} = (2.0, 0.8)$ .

```
"2BAR1: Two-Bar Truss: A first approximation (linear)"
$ Created on Wed Jul 10 17:41:03 2002
$
$ DESIGN VARIABLES
$
variables 2
  Variable 'Area' 2
    Lower bound variable 'Area' 0.2
    Upper bound variable 'Area' 4
    Range 'Area' 4
  Variable 'Base' 0.8
    Lower bound variable 'Base' 0.1
    Upper bound variable 'Base' 1.6
    Range 'Base' 1.6
solvers 1
responses 2
$
$ NO HISTORIES ARE DEFINED
$
$
$ DEFINITION OF SOLVER "RUNS"
$
  solver own 'RUNS'
  solver command "../.../2bar_com"
$
$ RESPONSES FOR SOLVER "RUNS"
$
  response 'Weight' 1 0 "cat wt"
  response 'Weight' linear
  response 'Stress' 1 0 "cat str"
  response 'Stress' linear
$
$ NO HISTORIES DEFINED FOR SOLVER "RUNS"
$
$
$ OBJECTIVE FUNCTIONS
$
  objectives 1
  objective 'Weight' 1
$
$ CONSTRAINT DEFINITIONS
$
  constraints 1
```

```

constraint 'Stress'
  upper bound constraint 'Stress' 1
$
$ EXPERIMENTAL DESIGN
$
  Order linear
  Experimental design dopt
  Basis experiment 3toK
  Number experiment 5
$
$ JOB INFO
$
  concurrent jobs 4
  iterate param design 0.01
  iterate param objective 0.01
  iterate 1
STOP

```

The input is echoed in the file `lsopt_input`.

The output is given in `lsopt_output` and in the View panel of LS-OPT*ui*.

A summary of the response surface statistics from the output file is given:

Approximating Response 'Weight' using 5 points (ITERATION 1)

```

-----
                Global error parameters of response surface
                -----
Linear Function Approximation:
-----
Mean response value           =      2.9413

RMS error                     =      0.7569 (25.73%)
Maximum Residual              =      0.8978 (30.52%)
Average Error                 =      0.7131 (24.24%)
Square Root PRESS Residual    =      2.5054 (85.18%)
Variance                     =      0.9549
R^2                           =      0.9217
R^2 (adjusted)               =      0.9217
R^2 (prediction)             =      0.1426
Determinant of [X]'[X]       =      3.5615

```

Approximating Response 'Stress' using 5 points (ITERATION 1)

```

-----
                Global error parameters of response surface
                -----
Linear Function Approximation:
-----
Mean response value           =      4.6210

RMS error                     =      2.0701 (44.80%)
Maximum Residual              =      4.1095 (88.93%)
Average Error                 =      1.6438 (35.57%)
Square Root PRESS Residual    =      3.9077 (84.56%)

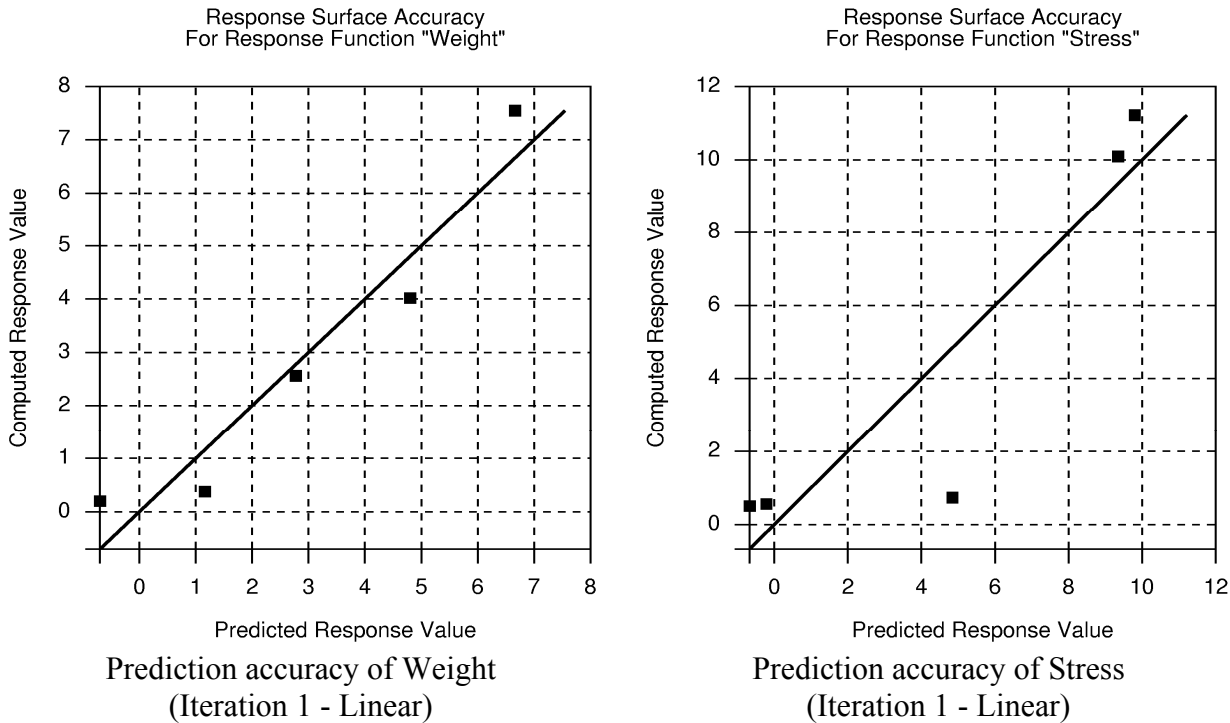
```



```

Variance                =      7.1420
R^2                    =      0.8243
R^2 (adjusted)         =      0.8243
R^2 (prediction)       =      0.3738
Determinant of [X]'[X] =      3.5615
    
```

The accuracy of the response surfaces can also be illustrated by plotting the predicted results vs. the computed results (Figure 22-2).



**Figure 22-2: Prediction accuracy of Weight and Stress (Iteration 1 – Linear)**

The  $R^2$  values are large. However the prediction accuracy, especially for weight, seems to be poor, so that a higher order of approximation will be required.

Nevertheless an improved design is predicted with the constraint value (stress) changing from an approximate 4.884 (severely violated) to 1.0 (the constraint is active). Due to inaccuracy, the actual constraint value of the optimum is 0.634. The weight changes from 2.776 to 4.137 (3.557 computed) to accommodate the violated stress:

```

DESIGN POINT
-----
Variable Name      Lower Bound  Value  Upper Bound
-----|-----|-----
Area              0.2         3.539    4
Base              0.1         0.1     1.6
-----|-----|-----
    
```

RESPONSE FUNCTIONS:

RESPONSE	Scaled		Unscaled	
	Computed	Predicted	Computed	Predicted
Weight	3.557	4.137	3.557	4.137
Stress	0.6338	1	0.6338	1

OBJECTIVE:

Computed Value = 3.557  
 Predicted Value = 4.137

OBJECTIVE FUNCTIONS:

OBJECTIVE NAME	Computed	Predicted	WT.
Weight	3.557	4.137	1

CONSTRAINT FUNCTIONS:

CONSTRAINT NAME	Computed	Predicted	Lower	Upper	Viol?
Stress	0.6338	1	-1e+30	1	no

CONSTRAINT VIOLATIONS:

CONSTRAINT NAME	Computed Violation		Predicted Violation	
	Lower	Upper	Lower	Upper
Stress	-	-	-	-

MAXIMUM VIOLATION:

Quantity	Computed		Predicted	
	Constraint	Value	Constraint	Value
Maximum Violation	Stress	0	Stress	6.995e-08
Smallest Margin	Stress	0.3662	Stress	6.995e-08

### 22.1.3. Updating the approximation to second order

To improve the accuracy, a second run is conducted using a quadratic approximation. The following statements differ from the input file above:

```
"2BAR2: Two-Bar Truss: Updating the approximation to 2nd order"
response 'Weight' quadratic
response 'Stress' quadratic
$
$ EXPERIMENTAL DESIGN
$
Order quadratic
Experimental design dopt
Basis experiment 5toK
Number experiment 10
```

The approximation results have improved considerably, but the stress approximation is still poor.

Approximating Response 'Weight' using 10 points (ITERATION 1)

-----  
 Global error parameters of response surface  
 -----

Quadratic Function Approximation:  
 -----

Mean response value	=	2.8402
RMS error	=	0.0942 (3.32%)
Maximum Residual	=	0.1755 (6.18%)
Average Error	=	0.0737 (2.59%)
Square Root PRESS Residual	=	0.2815 (9.91%)
Variance	=	0.0177
R <sup>2</sup>	=	0.9983
R <sup>2</sup> (adjusted)	=	0.9983
R <sup>2</sup> (prediction)	=	0.9851
Determinant of [X]'[X]	=	14.6629

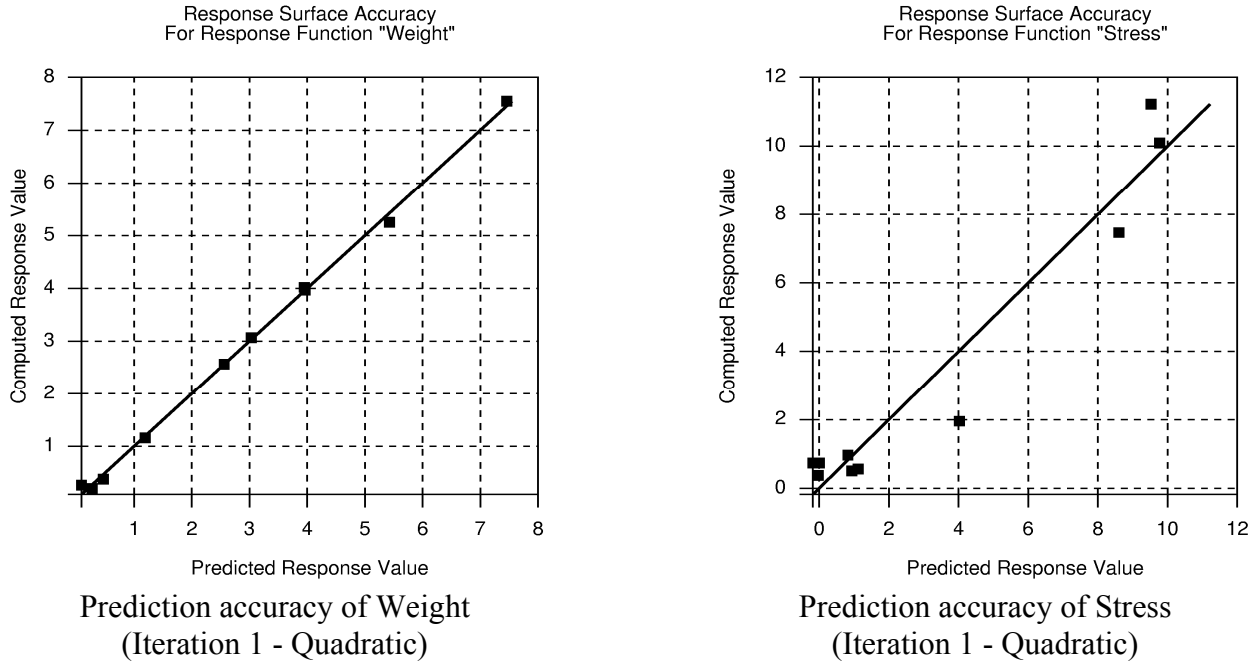
Approximating Response 'Stress' using 10 points (ITERATION 1)

-----  
 Global error parameters of response surface  
 -----

Quadratic Function Approximation:  
 -----

Mean response value	=	3.4592
RMS error	=	1.0291 (29.75%)
Maximum Residual	=	2.0762 (60.02%)
Average Error	=	0.8385 (24.24%)
Square Root PRESS Residual	=	2.4797 (71.68%)
Variance	=	2.1182
R <sup>2</sup>	=	0.9378
R <sup>2</sup> (adjusted)	=	0.9378
R <sup>2</sup> (prediction)	=	0.6387
Determinant of [X]'[X]	=	14.6629

The fit is illustrated below in Figure 22-3:



**Figure 22-3: Prediction accuracy of Weight and Stress (Iteration 1 – Quadratic)**

An improved design is predicted with the constraint value (stress) changing from a computed 0.734 to 1.0 (the approximate constraint becomes active). Due to inaccuracy, the actual constraint value of the optimum is a feasible 0.793. The weight changes from 2.561 to 1.925 (1.907 computed).

DESIGN POINT

Variable Name	Lower Bound	Value	Upper Bound
Area	0.2	1.766	4
Base	0.1	0.4068	1.6

RESPONSE FUNCTIONS:

RESPONSE	Scaled		Unscaled	
	Computed	Predicted	Computed	Predicted
Weight	1.907	1.925	1.907	1.925
Stress	0.7927	1	0.7927	1

OBJECTIVE:

Computed Value = 1.907  
 Predicted Value = 1.925

OBJECTIVE FUNCTIONS:

OBJECTIVE NAME	Computed	Predicted	WT.

```
Weight          |      1.907      1.925|  1
-----|-----|-----|-----
```

CONSTRAINT FUNCTIONS:

```
CONSTRAINT NAME | Computed | Predicted | Lower | Upper | Viol?
-----|-----|-----|-----|-----|-----
Stress          |  0.7927  |  1        | -1e+30 |      | 1 YES
-----|-----|-----|-----|-----|-----
```

CONSTRAINT VIOLATIONS:

```
CONSTRAINT NAME | Computed Violation | Predicted Violation |
-----|-----|-----|
| Lower | Upper | Lower | Upper |
-----|-----|-----|
Stress          | - | - | - | 1.033e-06 |
-----|-----|-----|
```

MAXIMUM VIOLATION:

```
Quantity | Computed | Predicted |
-----|-----|-----|
| Constraint | Value | Constraint | Value |
-----|-----|-----|
Maximum Violation | Stress | 0 | Stress | 1.033e-06 |
Smallest Margin | Stress | 0.2073 | Stress | 1.033e-06 |
-----|-----|-----|
```

### 22.1.4. Reducing the region of interest for further refinement

It seems that further accuracy can only be obtained by reducing the size of the subregion. In the following analysis, the current optimum (1.766; 0.4086) was used as a starting point while the region of interest was cut in half. The order of the approximation is quadratic. The modified statements are:

```
"2BAR3: Two-Bar Truss: Reducing the region of interest"
$ Created on Thu Jul 11 07:46:24 2002
$
$ DESIGN VARIABLES
  Range 'Area' 2
  Range 'Base' 0.8
```

The approximations have been significantly improved:

```
Approximating Response 'Weight' using 10 points (ITERATION 1)
```

```
-----
Global error parameters of response surface
-----
```

Quadratic Function Approximation:

```
-----
Mean response value          =      2.0282

RMS error                    =      0.0209 (1.03%)
Maximum Residual             =      0.0385 (1.90%)
```

```

Average Error           =      0.0157 (0.77%)
Square Root PRESS Residual =      0.0697 (3.44%)
Variance                =      0.0009
R^2                    =      0.9995
R^2 (adjusted)         =      0.9995
R^2 (prediction)       =      0.9944
Determinant of [X]'[X] =      0.0071
    
```

Approximating Response 'Stress' using 10 points (ITERATION 1)

-----  
Global error parameters of response surface  
-----

Quadratic Function Approximation:  
-----

```

Mean response value      =      1.2293

RMS error                =      0.0966 (7.85%)
Maximum Residual        =      0.1831 (14.89%)
Average Error           =      0.0826 (6.72%)
Square Root PRESS Residual =      0.3159 (25.69%)
Variance                =      0.0186
R^2                    =      0.9830
R^2 (adjusted)         =      0.9830
R^2 (prediction)       =      0.8182
Determinant of [X]'[X] =      0.0071
    
```

The results after one iteration are as follows:

DESIGN POINT

```

-----
Variable Name          Lower Bound  Value  Upper Bound
-----|-----|-----|-----
Area                   0.2      1.444      4
Base                   0.1      0.5408     1.6
-----|-----|-----|-----
    
```

RESPONSE FUNCTIONS:

```

-----
                |      Scaled      |      Unscaled      |
                |-----|-----|-----|-----|
RESPONSE        | Computed  Predicted| Computed  Predicted|
                |-----|-----|-----|-----|
Weight          |      1.642      1.627|      1.642      1.627|
Stress          |      0.9614      1|      0.9614      1|
                |-----|-----|-----|-----|
    
```

OBJECTIVE:

```

-----
Computed Value =      1.642
Predicted Value =      1.627
    
```

OBJECTIVE FUNCTIONS:

```

-----
OBJECTIVE NAME    | Computed  Predicted  WT.
-----|-----|-----|-----
Weight           |      1.642      1.627|      1
-----|-----|-----|-----
    
```

CONSTRAINT FUNCTIONS:

```

-----
CONSTRAINT NAME   | Computed | Predicted| Lower | Upper | Viol?
-----|-----|-----|-----|-----|-----
    
```

Stress	0.9614	1	-1e+30	1	no
--------	--------	---	--------	---	----

CONSTRAINT VIOLATIONS:

CONSTRAINT NAME	Computed Violation		Predicted Violation	
	Lower	Upper	Lower	Upper
Stress	-	-	-	-

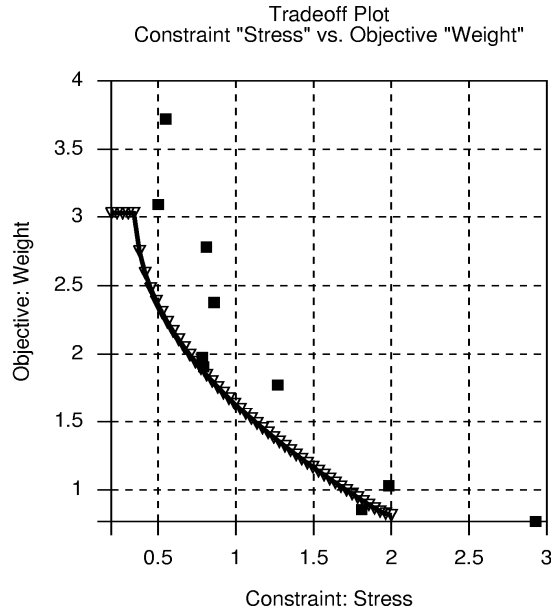
An improved design is predicted with the constraint value (stress) changing from an approximate 0.8033 (0.7928 computed) to 1.0 (the approximate constraint becomes active). Due to inaccuracy, the actual constraint value of the optimum is a feasible 0.961. This value is now much closer to the value of the simulation result. The weight changes from 1.909( 1.907 computed) to 1.627 (1.642 computed).

**22.1.5. Conducting a trade-off study**

The present region of interest (2; 0.8) is chosen in order to conduct a study in which the weight is traded off against the stress constraint. The trade-off is performed by selecting the Trade-off option in the View panel of LS-OPT*ui*.

The upper bound of the stress constraint is varied from 0.2 to 2.0 with 20 increments. Select Constraint as the Trade-off option and enter the bounds and number of increments. Generate the trade-off. This initiates the solution of a series of optimization problems using the response surface generated in Section 22.1.4, with the constraint in each (constant coefficient of the constraint response surface polynomial) being varied between the limits selected. The resulting curve is also referred to as a Pareto optimality curve. When plotting, select the ‘Constraint’ Stress, and not the ‘Response’ Stress, as the latter represents only the left-hand side of the constraint equation (17.2).

The resulting trade-off diagram (Figure 22-4) shows the compromise in weight when the stress constraint is tightened.



*Figure 22-4: Trade-off of stress and weight*

### 22.1.6. Automating the design process

This section illustrates the automation of the design process for both a linear and a quadratic response surface approximation order. 10 iterations are performed for the linear approximation, with only 5 iterations performed for the more expensive quadratic approximation.

The modified statements in the input file are as follows:

```
Variable 'Area' 2
  Range 'Area' 4
  Variable 'Base' 0.8
  Range 'Base' 1.6
$
$ EXPERIMENTAL DESIGN
$
Order linear
Number experiment 5
$
$ JOB INFO
$
iterate 10
```

for the linear approximation, and

```
$
$ EXPERIMENTAL DESIGN
$
Order quadratic
Number experiment 10
```



```

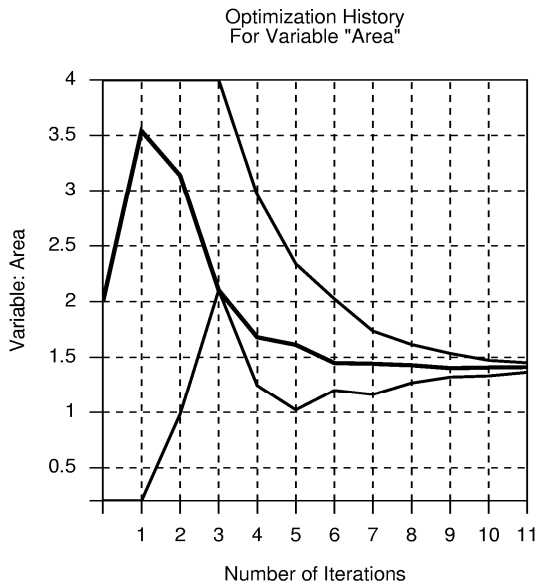
$
$ JOB INFO
$
iterate 5
    
```

The final results of the two types of approximations are as follows:

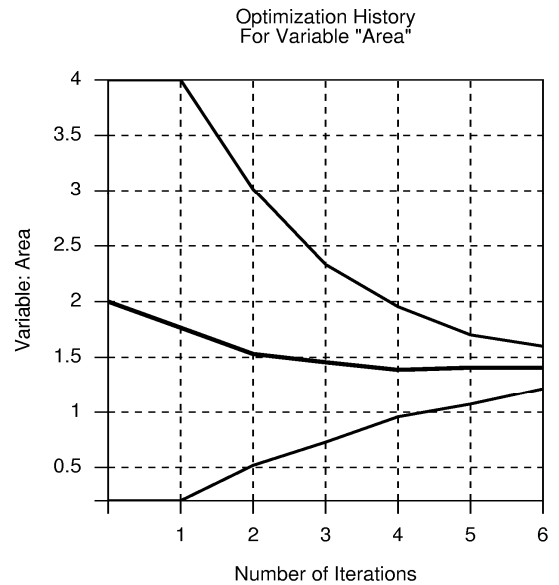
Table 22-1: Summary of final results (2-bar truss)

	Linear	Quadratic
Number of iterations	10	5
Number of simulations	51	51
Area	1.414	1.408
Base	0.3737	0.3845
Weight	1.51	1.509
Stress	0.9993	1.000

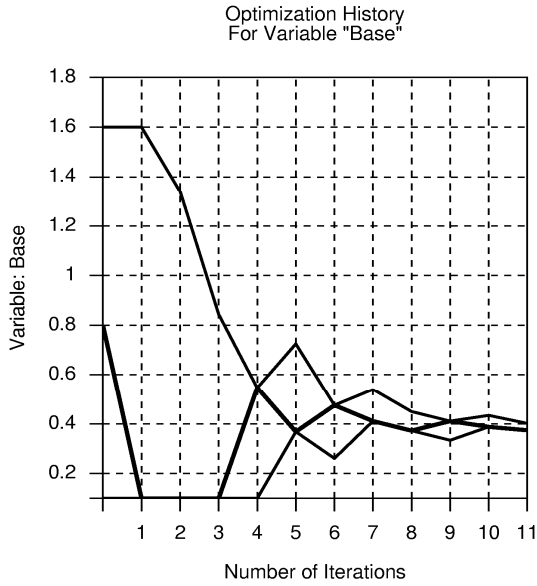
The optimization histories have been plotted to illustrate convergence in Figure 22-5.



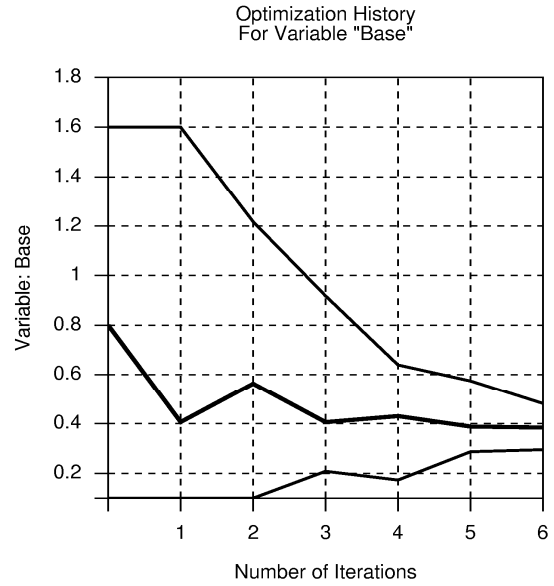
a) Optimization history of Area (Linear)



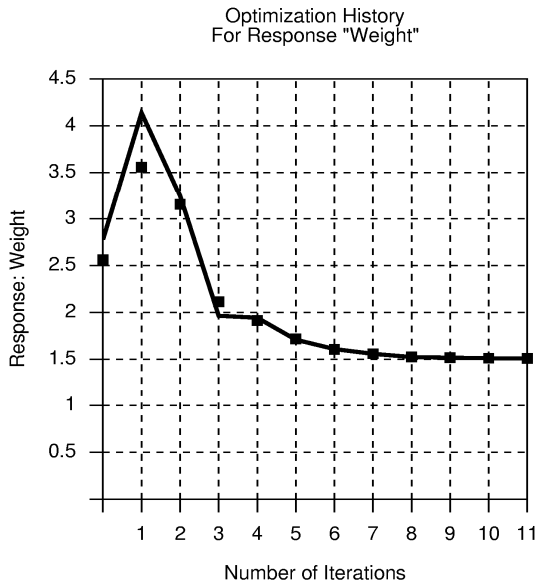
b) Optimization history of Area (Quadratic)



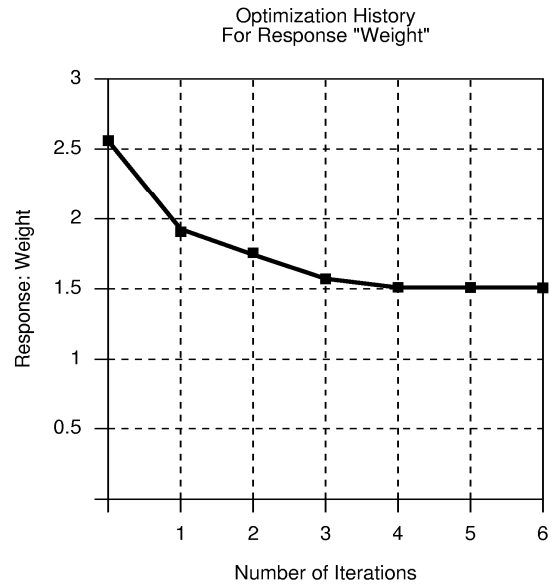
c) Optimization history of Base (Linear)



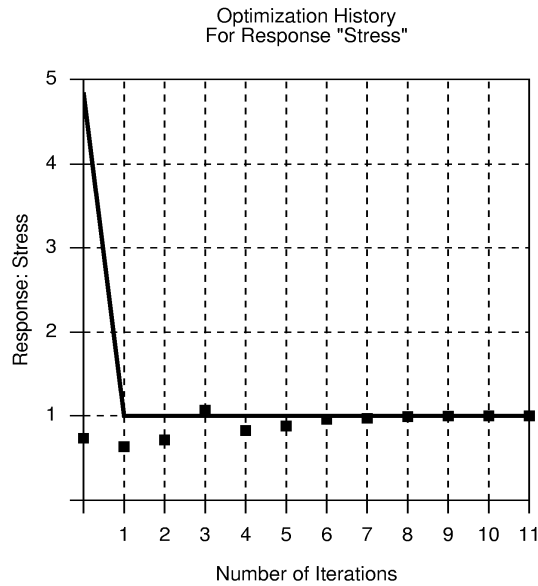
d) Optimization history of Base (Quadratic)



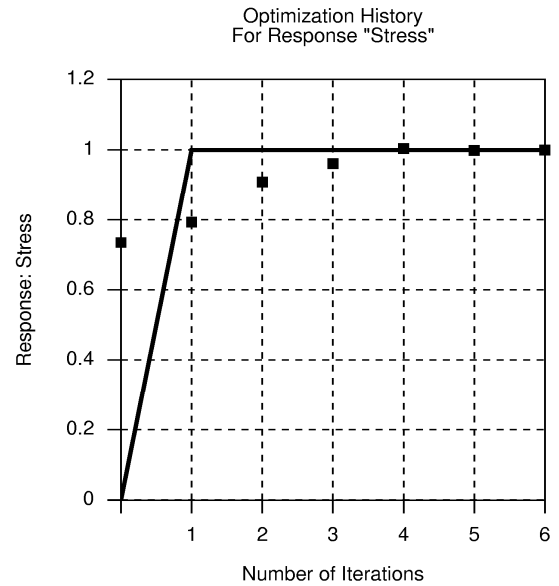
e) Optimization history of Weight (Linear)



f) Optimization history of Weight (Quadratic)



g) Optimization history of Stress (Linear)



h) Optimization history of Stress (Quadratic)

**Figure 22-5: Optimization history of design variables and responses (Linear and Quadratic)**

*Remarks:*

Note that the more accurate but more expensive quadratic approximation converges in about 3 design iterations (30 simulations), while it takes about 7 iterations (35 simulations) for the objective of the linear case to converge.

In general, the lower the order of the approximation, the more iterations are required to refine the optimum.

## 22.2. Small car crash (2 variables)

This example has the following features:

An LS-DYNA explicit crash simulation is performed.

Extraction is performed using standard LS-DYNA interfaces.

First- and second-order response surface approximations are compared.

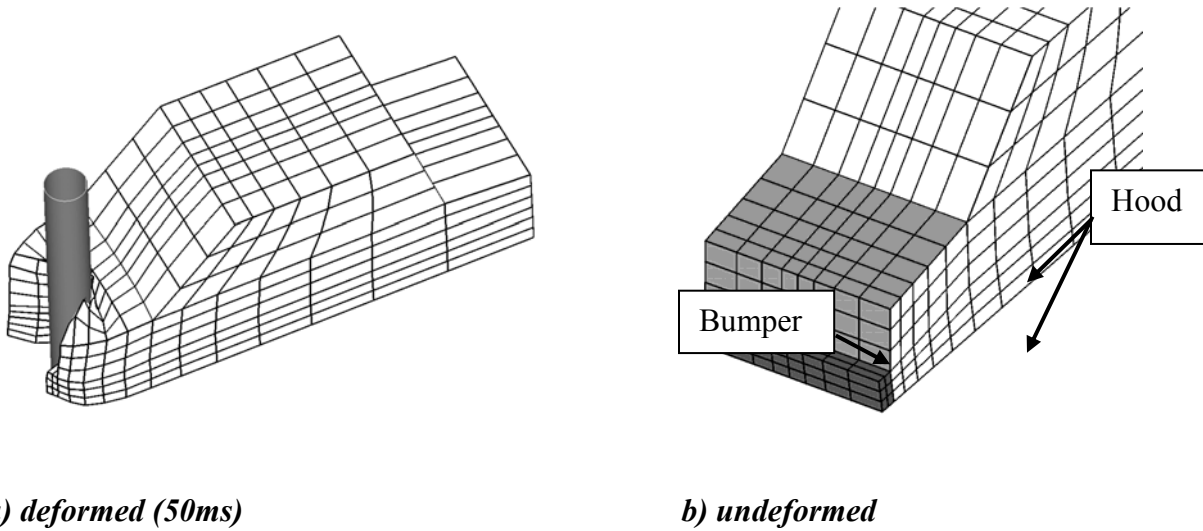
The design optimization process is automated.

A trade-off study is performed using both a quadratic and neural network approximation.

A limited reliability-based design optimization study is performed.

### 22.2.1. Introduction

This example considers the crashworthiness of a simplified small car model. A simplified vehicle moving at a constant velocity of  $15.64\text{m}\cdot\text{s}^{-1}$  (35mph) impacts a rigid pole. See Figure 22-6. The thickness of the front nose above the bumper is specified as part of the hood. LS-DYNA is used to perform a simulation of the crash for a simulation duration of 50ms.



*Figure 22-6: Small car impacting a pole*

**22.2.2. Design criteria and design variables**

The objective is to minimize the Head Injury Criterion (HIC) over a 15ms interval of a selected point subject to an intrusion constraint of 550mm of the pole into the vehicle at 50ms. The HIC is based on linear head acceleration and is widely used in occupant safety regulations in the automotive industry as a brain injury criterion. In summary, the criteria of interest are the following:

- Head injury criterion (HIC) of a selected point (15ms)
- Peak acceleration of a chosen point filtered at 60Hz (SAE).
- Component Mass of the structural components (bumper, front, hood and underside)
- Intrusion computed using the relative motion of two points
- Units are in *mm* and *sec*

The design variables are the shell thickness of the car front ( $t_{hood}$ ) and the shell thickness of the bumper ( $t_{bumper}$ ) (see Figure 22-6).

**22.2.3. Design formulation**

The design formulation is as follows:

Minimize

$$HIC(15ms) \tag{22-4}$$

subject to

## Intrusion (50ms) &lt; 550mm

The intrusion is measured as the difference between the displacement of nodes **167** and **432**.

**Remark:**

The mass is computed but not constrained. This is useful for monitoring the mass changes.

**22.2.4. Modeling**

The simulation is performed using LS-DYNA. An extract from the parameterized input deck is shown below. Note how the design variables are labeled for substitution through the characters << >>. The cylinder for impact is modeled as a rigid wall.

```

$
$ DEFINITION OF MATERIAL      1
$
*MAT_PLASTIC_KINEMATIC
1,1.000E-07,2.000E+05,0.300,400.,0.,0.
0.,0.,0.
*HOURLASS
1,0,0.,0,0.,0.
*SECTION_SHELL
1,2,0.,0.,0.,0.,0
2.00,2.00,2.00,2.00,0.
*PART
material type # 3 (Kinematic/Isotropic Elastic-Plastic)
1,1,1,0,1,0
$
$ DEFINITION OF MATERIAL      2
$
*MAT_PLASTIC_KINEMATIC
2,7.800E-08,2.000E+05,0.300,400.,0.,0.
0.,0.,0.
*HOURLASS
2,0,0.,0,0.,0.
*SECTION_SHELL
2,2,0.,0.,0.,0.,0
<<t_bumper>>,<<t_bumper>>,<<t_bumper>>,<<t_bumper>>,0.
*PART
material type # 3 (Kinematic/Isotropic Elastic-Plastic)
2,2,2,0,2,0
$
$ DEFINITION OF MATERIAL      3
$
*MAT_PLASTIC_KINEMATIC
3,7.800E-08,2.000E+05,0.300,400.,0.,0.
0.,0.,0.
*HOURLASS
3,0,0.,0,0.,0.
*SECTION_SHELL
3,2,0.,0.,0.,0.,0
<<t_hood>>,<<t_hood>>,<<t_hood>>,<<t_hood>>,0.
*PART

```

```

material type # 3 (Kinematic/Isotropic Elastic-Plastic)
3,3,3,0,3,0
$
$ DEFINITION OF MATERIAL      4
$
*MAT_PLASTIC_KINEMATIC
4,7.800E-08,2.000E+05,0.300,400.,0.,0.
0.,0.,0.
*HOURGLASS
4,0,0.,0,0.,0.
*SECTION_SHELL
4,2,0.,0.,0.,0.,0
<<t_hood>>,<<t_hood>>,<<t_hood>>,<<t_hood>>,0.
*PART
material type # 3 (Kinematic/Isotropic Elastic-Plastic)
4,4,4,0,4,0
$
$ DEFINITION OF MATERIAL      5
$
*MAT_PLASTIC_KINEMATIC
5,7.800E-08,2.000E+05,0.300,400.,0.,0.
0.,0.,0.
*HOURGLASS
5,0,0.,0,0.,0.
*SECTION_SHELL
5,2,0.,0.,0.,0.,0
<<t_hood>>,<<t_hood>>,<<t_hood>>,<<t_hood>>,0.
*PART
material type # 3 (Kinematic/Isotropic Elastic-Plastic)
5,5,5,0,5,0
$

```

### 22.2.5. First linear iteration

A design space of [1; 5] is used for both design variables with no range specified. This means that the range defaults to the whole design space. The LS-OPT input file is as follows:

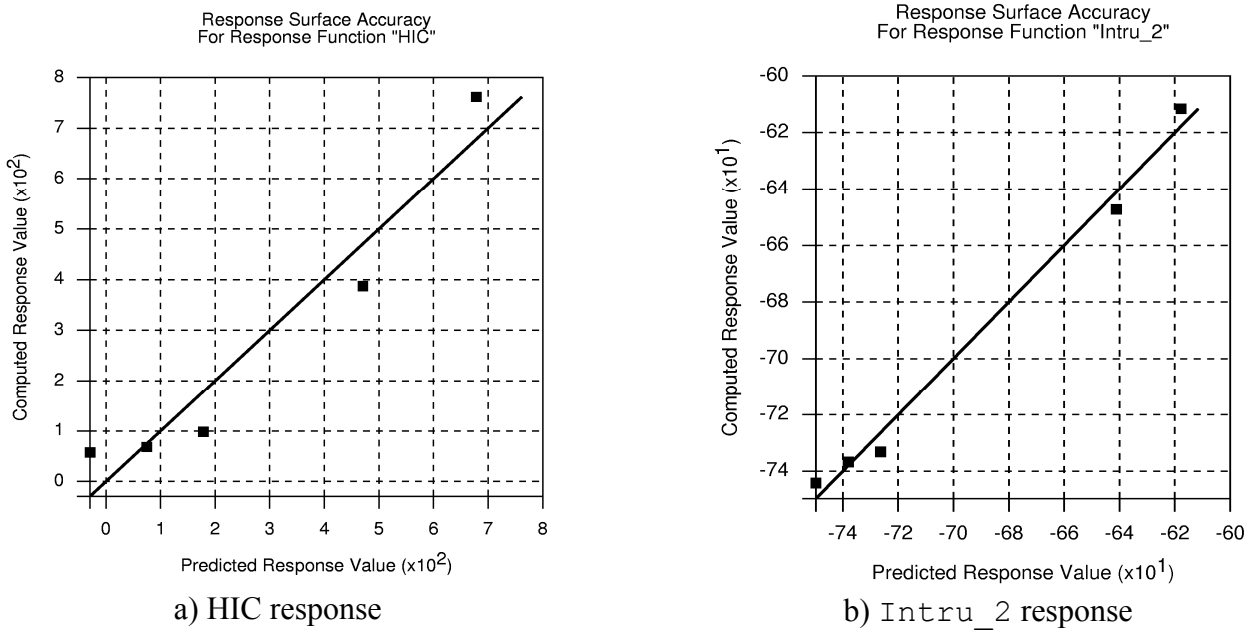
```

"Small Car Problem: EX4a"
$ Created on Mon Aug 26 19:11:06 2002
solvers 1
responses 5
$
$ NO HISTORIES ARE DEFINED
$
$
$ DESIGN VARIABLES
$
variables 2
Variable 't_hood' 1
  Lower bound variable 't_hood' 1
  Upper bound variable 't_hood' 5
Variable 't_bumper' 3
  Lower bound variable 't_bumper' 1
  Upper bound variable 't_bumper' 5
$

```

```
$ DEFINITION OF SOLVER "1"
$
solver dyna '1'
  solver command "lsdyna"
  solver input file "car5.k"
  solver append file "rigid2"
  solver order linear
  solver experiment design dopt
  solver number experiments 5
  solver basis experiment 3toK
  solver concurrent jobs 1
$
$ RESPONSES FOR SOLVER "1"
$
response 'Acc_max' 1 0 "DynaASCII Nodout X_ACC 432 Max SAE 60"
response 'Acc_max' linear
response 'Mass' 1 0 "DynaMass 2 3 4 5 MASS"
response 'Mass' linear
response 'Intru_2' 1 0 "DynaASCII Nodout X_DISP 432 Timestep"
response 'Intru_2' linear
response 'Intru_1' 1 0 "DynaASCII Nodout X_DISP 167 Timestep"
response 'Intru_1' linear
response 'HIC' 1 0 "DynaASCII Nodout HIC15 9810. 1 432"
response 'HIC' linear
$
$ NO HISTORIES DEFINED FOR SOLVER "1"
$
$
$ HISTORIES AND RESPONSES DEFINED BY EXPRESSIONS
$
composites 1
composite 'Intrusion' type weighted
  composite 'Intrusion' response 'Intru_2' -1 scale 1
  composite 'Intrusion' response 'Intru_1' 1 scale 1
$
$ OBJECTIVE FUNCTIONS
$
objectives 1
objective 'HIC' 1
$
$ CONSTRAINT DEFINITIONS
$
constraints 1
constraint 'Intrusion'
  upper bound constraint 'Intrusion' 550
$
$ JOB INFO
$
iterate param design 0.01
iterate param objective 0.01
iterate 1
STOP
```

The computed vs. predicted HIC and *Intru\_2* responses are given in Figure 22-7. The corresponding  $R^2$  value for HIC is 0.9248, while the RMS error is 27.19%. For *Intru\_2*, the  $R^2$  value is 0.9896, while the RMS error is 0.80%.



**Figure 22-7: Computed vs. predicted responses – Linear approximation**

The summary data for the first iteration is:

Baseline:

-----  
 ITERATION NUMBER (Baseline)  
 -----

DESIGN POINT  
 -----

Variable Name	Lower Bound	Value	Upper Bound
t_hood	1	1	5
t_bumper	1	3	5

RESPONSE FUNCTIONS:  
 -----

RESPONSE	Scaled		Unscaled	
	Computed	Predicted	Computed	Predicted
Acc_max	8.345e+04	1.162e+05	8.345e+04	1.162e+05
Mass	0.4103	0.4103	0.4103	0.4103
Intru_2	-736.7	-738	-736.7	-738
Intru_1	-161	-160.7	-161	-160.7



```
HIC          |          68.26      74.68 |          68.26      74.68 |
-----|-----|-----|-----|
```

and 1<sup>st</sup> optimum:

DESIGN POINT

```
-----|-----|-----|-----|
Variable Name      Lower Bound  Value  Upper Bound
-----|-----|-----|-----|
t_hood             1           1.549    5
t_bumper           1           5         5
-----|-----|-----|-----|
```

RESPONSE FUNCTIONS:

```
-----|-----|-----|-----|
                Scaled          Unscaled
-----|-----|-----|-----|
RESPONSE        | Computed  Predicted | Computed  Predicted |
-----|-----|-----|-----|
Acc_max         | 1.248e+05 1.781e+05 | 1.248e+05 1.781e+05 |
Mass            | 0.6571    0.657 | 0.6571    0.657 |
Intru_2         | -713.7    -711.4 | -713.7    -711.4 |
Intru_1         | -164.6    -161.4 | -164.6    -161.4 |
HIC             | 126.7     39.47 | 126.7     39.47 |
-----|-----|-----|-----|
```

### 22.2.6. First quadratic iteration

The LS-OPT input file is modified as follows (the response approximations are all quadratic (not shown)):

```
Order quadratic
Experimental design dopt
Basis experiment 5toK
Number experiment 10
```

For very expensive simulations, if a previously extracted simulation is available, as, e.g., from the previous linear iteration in Section 22.2.5, then these points can be used to reduce the computational cost of this quadratic approximation. To do this, the previous `AnalysisResults_1.csv` file is copied to the current case directory before restarting the LS-OPT run. See also Section 13.7 on augmentation of existing results.

As is shown in the results below, the computed vs. predicted HIC and `Intru_2` responses are now improved from the linear approximation. The accuracy of the HIC and `Intru_2` responses are given in Figure 22-8. The corresponding  $R^2$  value for HIC is 0.9767, while the RMS error is 10.28%. For `Intru_2`, the  $R^2$  value is 0.9913, while the RMS error is 0.61%. When conducting trade-off studies, a higher-order approximation like the current one will be preferable. See trade-off of HIC versus intrusion in a range 450mm to 600mm, in Figure 22-8c).

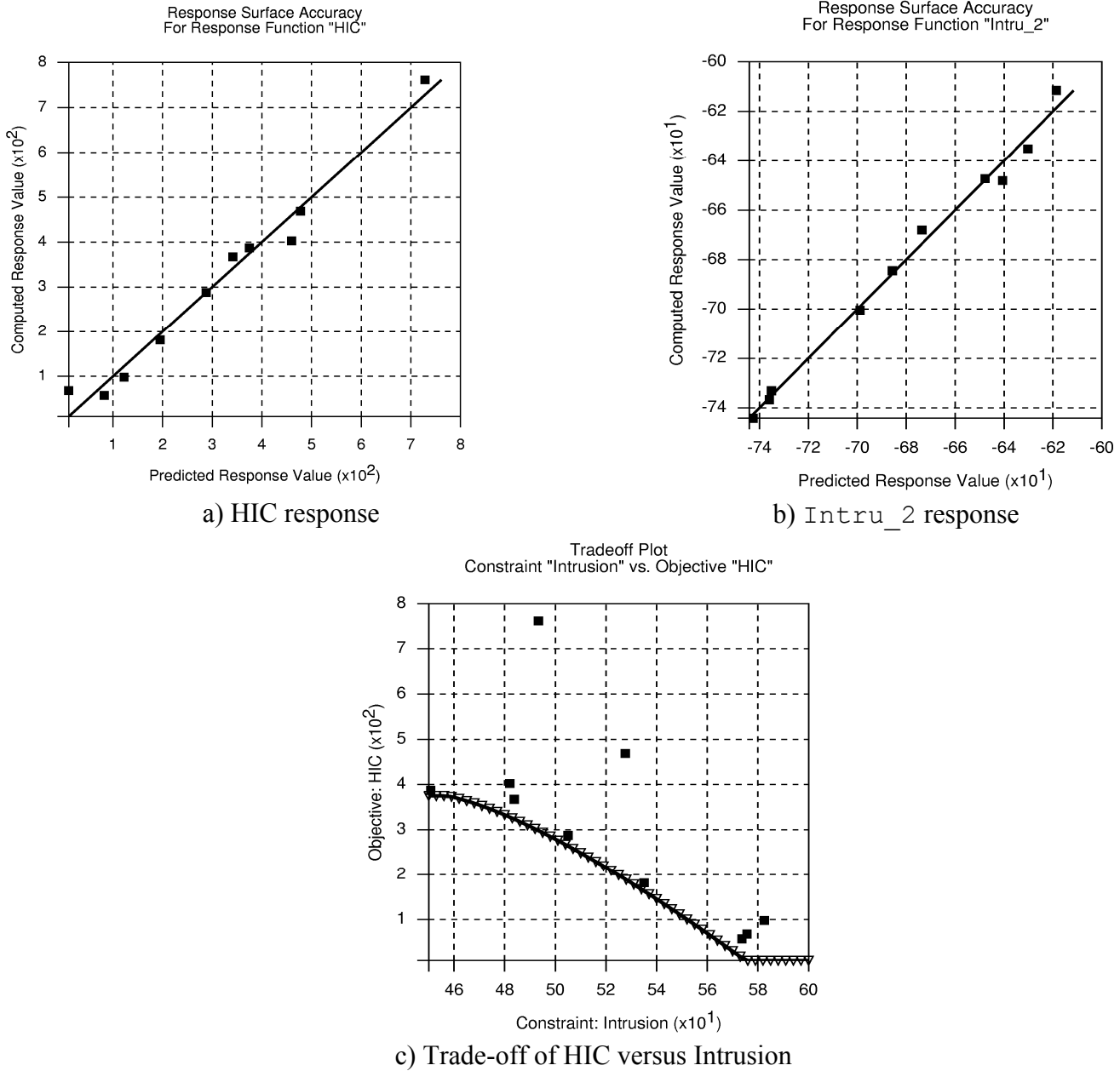


Figure 22-8: Computed vs. predicted responses and trade-off – Quadratic approximation

The summary data for the first iteration is:

Baseline:

-----  
 ITERATION NUMBER (Baseline)  
 -----

DESIGN POINT

```

-----
Variable Name          Lower Bound   Value   Upper Bound
-----|-----|-----|-----
t_hood                 1           1         5
t_bumper               1           3         5
-----|-----|-----|-----

```

RESPONSE FUNCTIONS:

```

-----
RESPONSE              |          Scaled          |          Unscaled          |
-----|-----|-----|-----|-----|
                   | Computed  Predicted | Computed  Predicted |
-----|-----|-----|-----|-----|
Acc_max              | 8.345e+04 1.385e+05 | 8.345e+04 1.385e+05 |
Mass                 | 0.4103    0.4103    | 0.4103    0.4103    |
Intru_2              | -736.7    -736           | -736.7    -736           |
Intru_1              | -161      -160.3         | -161      -160.3         |
HIC                  | 68.26     10.72          | 68.26     10.72          |
-----|-----|-----|-----|-----|

```

and 1<sup>st</sup> optimum:

DESIGN POINT

```

-----
Variable Name          Lower Bound   Value   Upper Bound
-----|-----|-----|-----
t_hood                 1           1.653     5
t_bumper               1           3.704     5
-----|-----|-----|-----

```

RESPONSE FUNCTIONS:

```

-----
RESPONSE              |          Scaled          |          Unscaled          |
-----|-----|-----|-----|-----|
                   | Computed  Predicted | Computed  Predicted |
-----|-----|-----|-----|-----|
Acc_max              | 1.576e+05 1.985e+05 | 1.576e+05 1.985e+05 |
Mass                 | 0.6017    0.6018    | 0.6017    0.6018    |
Intru_2              | -712.7    -711.9     | -712.7    -711.9     |
Intru_1              | -163.3    -161.9     | -163.3    -161.9     |
HIC                  | 171.4     108.2      | 171.4     108.2      |
-----|-----|-----|-----|-----|

```

### 22.2.7. Automated run

An automated optimization is performed with a linear approximation. The LS-OPT input file is modified as follows:

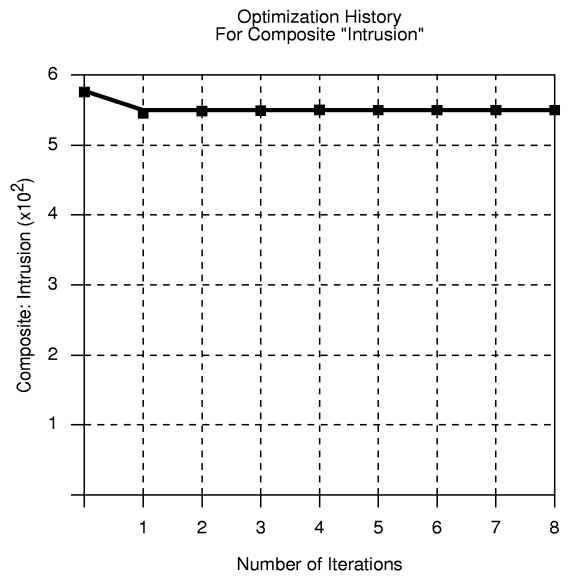
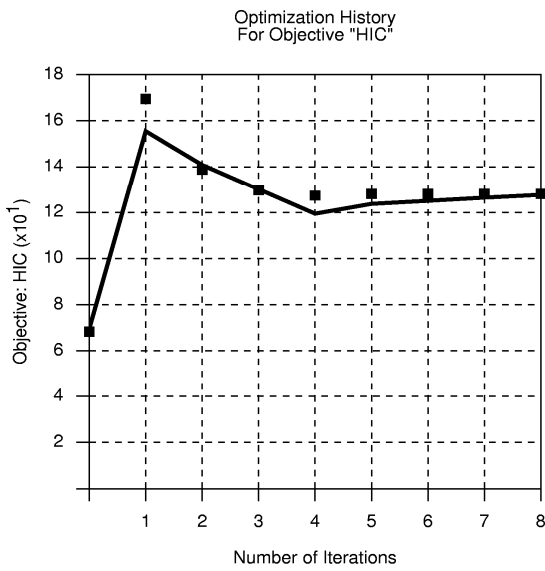
```

Order linear
Experimental design dopt
Basis experiment 3toK
Number experiment 5

```

```
iterate 8
```

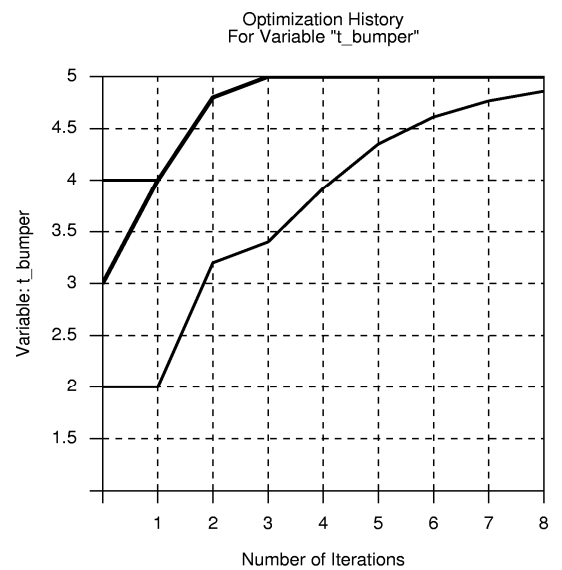
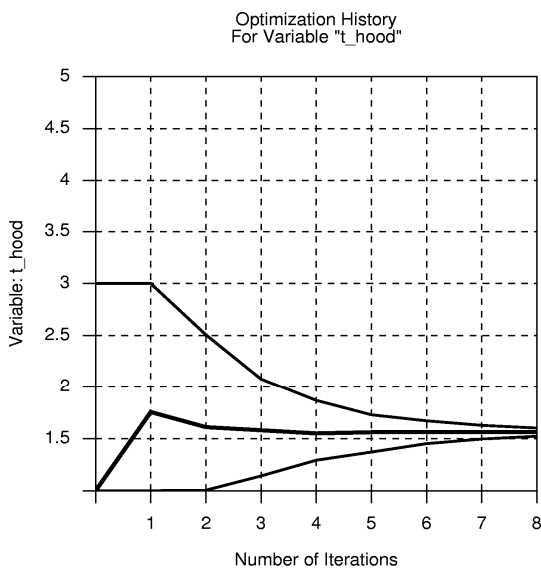
It can be seen in Figure 22-9 that the objective function (HIC) and intrusion constraint are approximately optimized at the 5<sup>th</sup> iteration. It takes about 8 iterations for the approximated (solid line) and computed (square symbols) HIC to correspond. The approximation improves through the contraction of the subregion. As the variable  $t_{hood}$  never moves to the edge of the subregion during the optimization process, the heuristic in LS-OPT enforces pure zooming (see Figure 22-10). For  $t_{bumper}$ , panning occurs as well due to the fact that the linear approximation predicts a variable on the edge of the subregion.



a) Optimization history of HIC

b) Optimization history of Intrusion

Figure 22-9: Optimization history of HIC and Intrusion



a) Optimization history of  $t_{hood}$

b) Optimization history of  $t_{bumper}$

Figure 22-10: Optimization history of design variables

### 22.2.8. Trade-off using neural network approximation

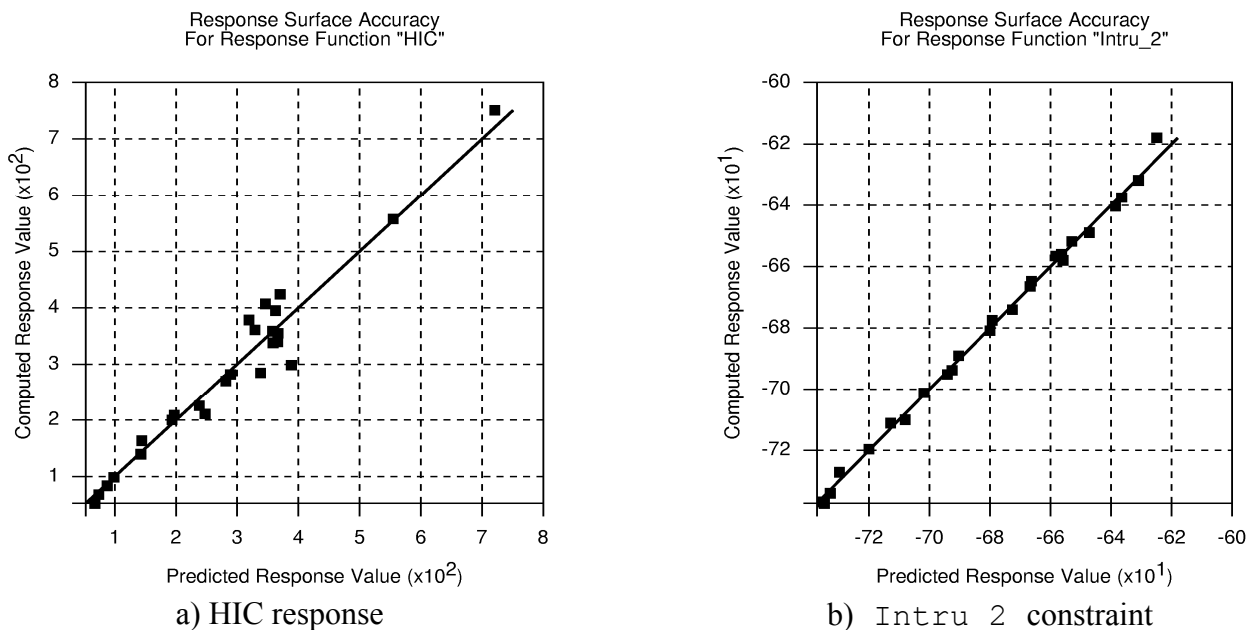
In order to build a more accurate response surface for trade-off studies, the Neural Net method is chosen under the ExpDesign panel. This results in a feedforward (FF) neural network (Section 3.1) being solved for the points selected. The recommended point selection scheme (Space Filling) is used. One iteration is performed to analyze only one experimental design with 25 points. The modifications to the command input file are as follows:

```

$
$ DEFINITION OF SOLVER "1"
$
  solver dyna '1'
  solver command "lsdyna"
  solver input file "car5.k"
  solver append file "rigid2"
  solver order FF
  solver update doe
  solver experiment design space_filling
  solver number experiments 25
iterate 1

```

The response surface accuracy is illustrated in Figure 22-11 for the HIC and Intru\_2 responses. The HIC has more scatter than Intru\_2 for the 25 design points used.



**Figure 22-11: Response surface accuracy using neural network approximation**

A trade-off study considers a variation in the Intrusion constraint (originally fixed at 550mm) between 450 and 600mm, the same as in Figure 22-8c). The experimental design used for the responses in Figure 22-11 is shown in Figure 22-12. The effect of the Space-Filling algorithm in maximizing the minimum distance between the experimental design points can clearly be seen from the evenly distributed design. The resulting Pareto optimality curves for HIC and the two design variables ( $t_{hood}$  and  $t_{bumper}$ ) can be seen in Figure 22-13. It can be seen that a tightening of the Intrusion constraint increases the HIC value through an increase of the hood thickness in the optimal design.

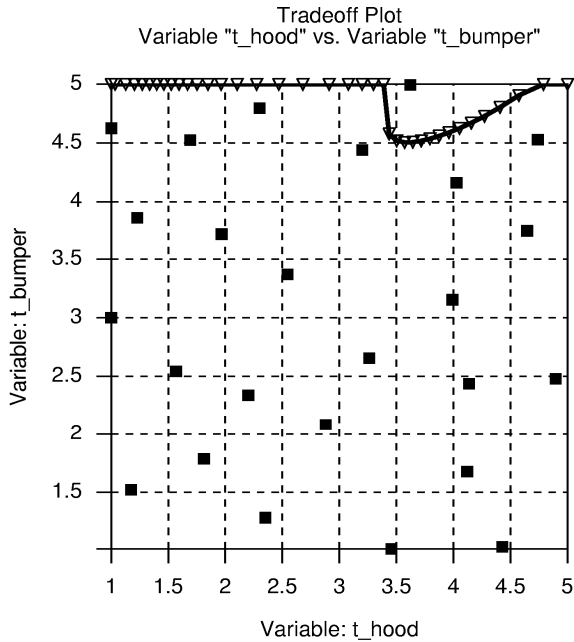
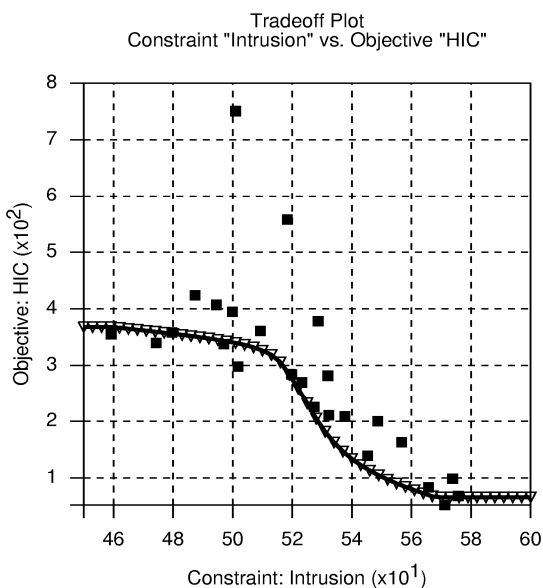
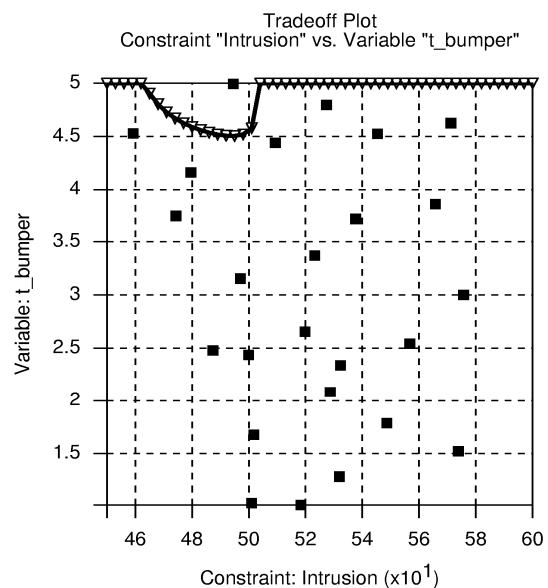


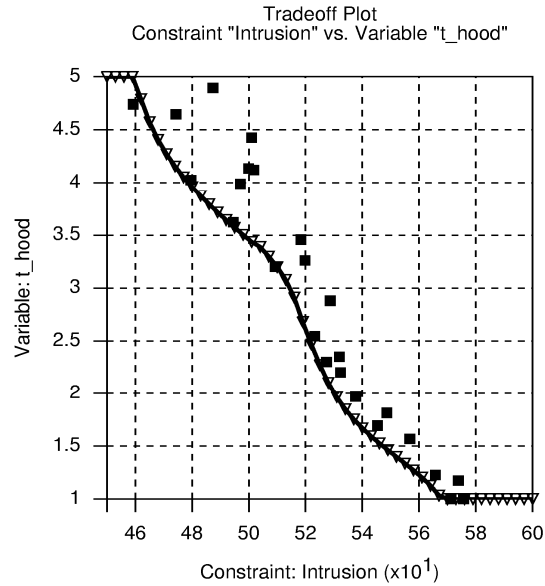
Figure 22-12: Experimental design points used for trade-off



a) Objective (HIC) versus Intrusion constraint



b)  $t_{bumper}$  versus Intrusion constraint

c)  $t_{hood}$  versus Intrusion constraint**Figure 22-13: Trade-off results – Small car (2 variables)**

### 22.2.9. Mixed-discrete optimization

Mixed discrete optimization is achieved simply by setting the  $t_{hood}$  variable to be discrete with possible values of 1.0, 2.0, 3.0, 4.0, and 5.0. The input file commands describing the variables are:

```

$
$ DESIGN VARIABLES
$
variables 2
Variable 't_bumpr' 1
  Lower bound variable 't_bumpr' 1
  Upper bound variable 't_bumpr' 5
  Range 't_bumpr' 4
Variable 't_hood' 1
  Variable 't_hood' discrete {1 2 3 4 5 }
$

```

The results design variables histories are shown in Figure 22-14.



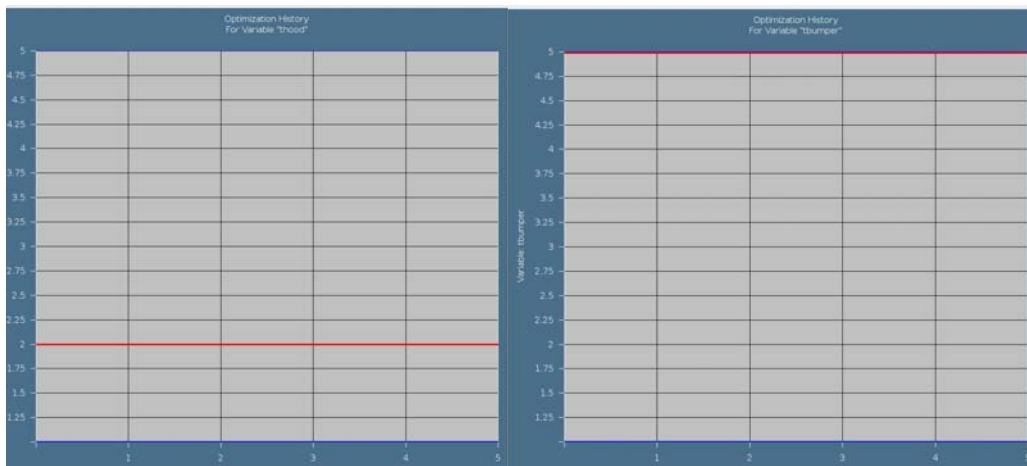


```

GA Parameter Elitism 1
GA Parameter NumElites 2
GA Parameter Real Crossover Type 1
GA Parameter Real Crossover Probability 0.99
GA Parameter Real Crossover Distribution Index 5.0
GA Parameter Binary Crossover Type 2
GA Parameter Binary Crossover Probability 1.0
GA Parameter Real Mutation Probability 1.0
GA Parameter Real Mut Dist Index 5.0
GA Parameter Binary Mutation Probability 0.05
GA Parameter Restart Status 0
GA Parameter Seed 854526
    
```

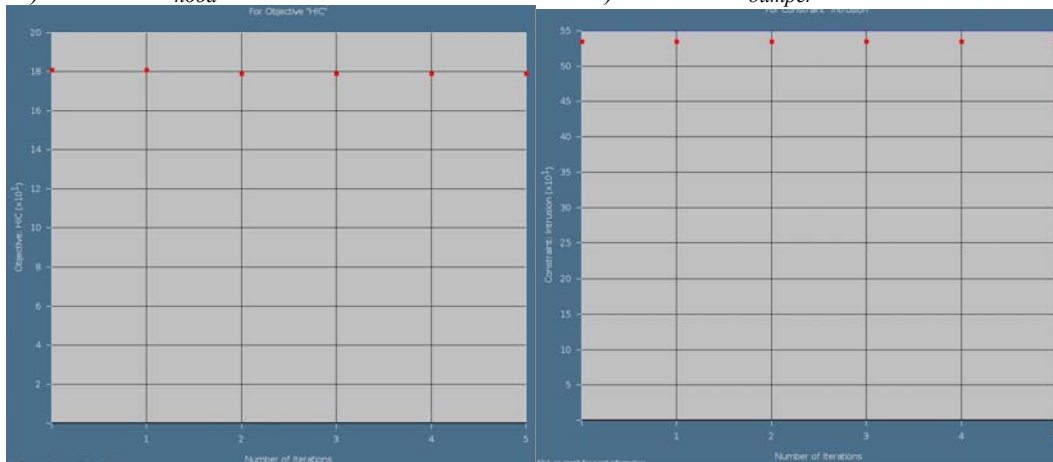
\$

The outcome of the optimization is shown in Figure 22-15. In the chosen example, there is small variation in the optimized results with generation. The discrete variable was fixed at 2 units and the variations in the bumper thickness were very small. Consequently, the reduction in HIC and intrusion values are not visible in the optimization history, though there were small improvements. Note that the optimization history treats ‘generation’ as ‘iteration’ to display results.



A) Variable  $t_{hood}$

B) Variable  $t_{bumper}$



C) Objective HIC

D) Constraint Intrusion

*Figure 22-15 Optimization history of mixed-discrete variable optimization using direct GA simulation.*

### 22.2.11. RBDO (Reliability-based design optimization) using FOSM (First Order Second Moment Method)\*

The First Order Second Moment reliability-based design optimization in LS-OPT is illustrated in this example. The optimization problem is modified as follows:

Minimize

$$\text{HIC} \quad (22-5)$$

subject to  $\text{Probability}[\text{Intrusion} > 550\text{mm}] < 10^{-6}$

The formulation in Eq. HIC (22-5 implies that the car is made safer by 6 standard deviations of the intrusion.

The following commands must be added to the LS-OPT input file used for the automated run (Section 22.2.7):

```
$
$ Define distributions
$
Distributions 2
distribution 'hood_dist' UNIFORM -0.05 0.05
distribution 'bumper_dist' UNIFORM -0.05 0.05
$
$ Assign distributions to variables
$
variable 't_hood' distribution 'hood_dist'
variable 't_bumper' distribution 'bumper_dist'
$
$ Assign probabilistic bounds to constraints
$
probability upper bound constraint 'Intrusion' 1e-6
```

The results are:  $x = \langle 1.78, 3.44 \rangle$ , a HIC value of 182, and an intrusion of 545 with a standard deviation of 1.06.

## 22.3. Impact of a cylinder (2 variables)

This example has the following features:

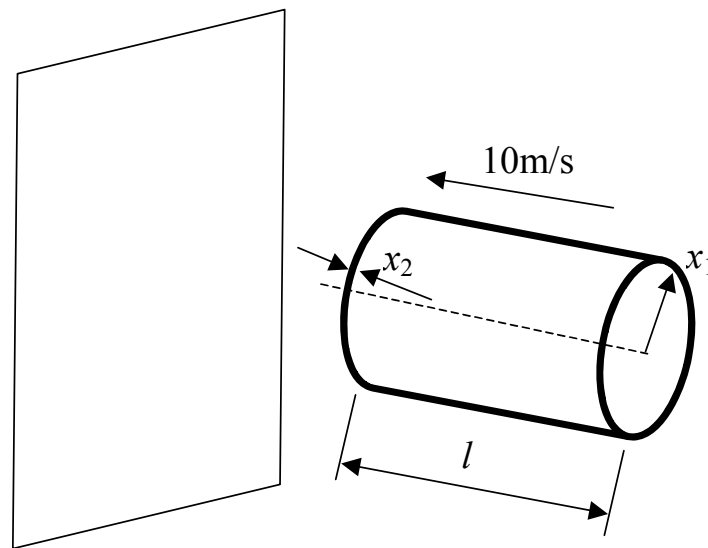
An LS-DYNA explicit impact simulation is performed.

An independent parametric preprocessor is used to incorporate shape optimization.  
Extraction is performed using standard ASCII LS-DYNA interfaces.  
Second-order response surface approximations are compared using different subregions.  
The design optimization process is automated.  
Noisy response variables are improved using filtering.

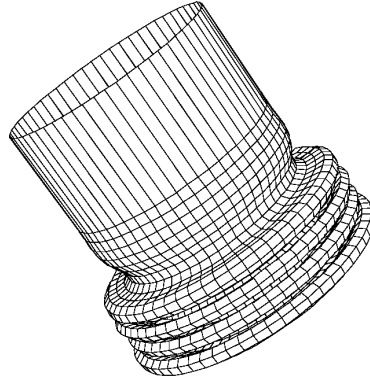
The example in this chapter is modeled on one by Yamazaki [1].

### 22.3.1. Problem statement

The problem consists of a tube impacting a rigid wall as shown in Figure 22-16. The energy absorbed is maximized subject to a constraint on the rigid wall impact force. The cylinder has a constant mass of 0.54 kg with the design variables being the mean radius and thickness. The length of the cylinder is thus dependent on the design variables because of the mass constraint. A concentrated mass of 500 times the cylinder weight is attached to the end of the cylinder not impacting the rigid wall. The deformed shape at 20ms is shown in Figure 22-17 for a typical design.



*Figure 22-16: Impacting cylinder*



**Figure 22-17: Deformed finite element model (time = 20ms)**

The optimization problem is stated as:

$$\text{Maximize } E_{\text{internal}}(x_1, x_2) \Big|_{t=0.02}$$

subject to

$$F_{\text{normal}}^{\text{wall}}(x_1, x_2) \Big|_{\text{average}} \leq 70000$$

$$l(x) = \frac{0.52}{2\pi\rho x_1 x_2}$$

where the design variables  $x_1$  and  $x_2$  are the radius and the thickness of the cylinder respectively.  $E_{\text{internal}}(x) \Big|_{t=0.02}$  is the objective function and constraint functions  $F_{\text{normal}}^{\text{wall}}(x) \Big|_{\text{average}}$  and  $l(x)$  are the average normal force on the rigid wall and the length of the cylinder, respectively.

The problem is simulated using LS-DYNA. The following TrueGrid input file including the `<<name>>` statements is used to create the FE input deck with the FE model as shown in Figure 22-17. Note that the design variables have been scaled.

```
c cyl2 - crush cylinder - constant volume
lsdyna3d keyword
lsdyopts secforc .00002 rwforc .00002 ;
lsdyopts endtim .02 d3plot dtcycl .0001 ; ;
lsdyopts thkchg 2 ;
lsdyopts elout 0.001
lsdyopts glstat 0.001
lsdymats 1 3 rho 2880 shell elfor bt tsti 4
      e 71.38e9 pr .33 sigy 102.0e6 etan 0.2855e9 ;
lsdymats 2 20 rho 14.3e6 e 7.138e10 pr .33 cmo con 4 7 shell elfor bt tsti 4;
para
  r [<<Radius>>/1000.0]
```

```

1 [3.0e+1/<<Radius>>/<<Wall_Thickness>>]
h [<<Wall_Thickness>>/1000.0]
12 [75.0/<<Radius>>*0.02]
h2 .002
v0 10.
n .33
pi 3.14159
;
plane 1 0 0 -.002 0 0 1 .001 ston pen 2. stick ;
sid 1 ldsi 13 slvmat 1;scoef .4 dcoef .4 sfsp 1.5 ; ; ;
c ***** part 1 mat 1 ***** shell
cylinder
-1; 1 60; 1 50 51;
%r
0 360
0 %1 [%12+%1]
dom 1 1 1 1 2 3
  x=x+.01*%h*sin(%pi*z*57.3/(%pi*(%r*%r*%h*%h/(12*(1-%n*%n))))**.25)
thick %h
thi ;;2 3; %h2
c bi ; -3 0 -3; dx 1 dy 1 rx 1 ry 1 rz 1 ;
c interrupt
swi ;; ;1
velocity 0 0 [-%v0]
mate 1
mti ;; 2 3; 2
c element spring block
epb 1 1 1 1 2 3
endpart
merge
stp .000001
write
end

```

### 22.3.2. A first approximation

In the first iteration, a quadratic approximation is chosen from the beginning. The ASCII database is suitable for this analysis as the energy and impact force can be extracted from the `glstat` and `rwforc` databases respectively. Five processors are available. The region of interest is arbitrarily chosen to be about half the size of the design space.

The following LS-OPT command input deck was used to find the approximate optimum solution:

```

"Cylinder Impact Problem"
$ Created on Thu Jul 11 11:37:33 2002
$
$ DESIGN VARIABLES
$
variables 2
  Variable 'Radius' 75
  Lower bound variable 'Radius' 20
  Upper bound variable 'Radius' 100
  Range 'Radius' 50

```

```

Variable 'Wall_Thickness' 3
  Lower bound variable 'Wall_Thickness' 2
  Upper bound variable 'Wall_Thickness' 6
  Range 'Wall_Thickness' 2
solvers 1
responses 2
$
$ NO HISTORIES ARE DEFINED
$
$
$ DEFINITION OF SOLVER "RUN1"
$
  solver dyna960 'RUN1'
    solver command "lsdyna"
    solver input file "trugrdo"
    prepro truegrid
    prepro command "/net/src/ultra4_4/common/hp/tg2.1/tg"
    prepro input file "cyl2"
$
$ RESPONSES FOR SOLVER "RUN1"
$
  response 'Internal_Energy' 1 0 "DynaASCII Glstat I_Ener 0 Timestep"
  response 'Internal_Energy' quadratic
  response 'Rigid_Wall_Force' 1 0 "DynaASCII rwforc normal 1 ave"
  response 'Rigid_Wall_Force' quadratic
$
$ NO HISTORIES DEFINED FOR SOLVER "RUN1"
$
$
$ OBJECTIVE FUNCTIONS
$
  objectives 1
  maximize
  objective 'Internal_Energy' 1
$
$ CONSTRAINT DEFINITIONS
$
  constraints 1
  constraint 'Rigid_Wall_Force'
    upper bound constraint 'Rigid_Wall_Force' 70000
$
$ EXPERIMENTAL DESIGN
$
  Order quadratic
  Experimental design dopt
  Basis experiment 5toK
  Number experiment 10
$
$ JOB INFO
$
  concurrent jobs 5
  iterate param design 0.01
  iterate param objective 0.01
  iterate 1
STOP

```

The curve-fitting results below show that the internal energy is approximated reasonably well whereas the average force is poorly approximated. The accuracy plots confirm this result (Figure 22-18).

Approximating Response 'Internal\_Energy' using 10 points (ITERATION 1)

```

-----
                Global error parameters of response surface
-----
Quadratic Function Approximation:
-----
Mean response value          = 10686.0081

RMS error                    = 790.3291 (7.40%)
Maximum Residual             = 1538.9208 (14.40%)
Average Error                 = 654.4415 (6.12%)
Square Root PRESS Residual   = 2213.7994 (20.72%)
Variance                     = 1249240.2552
R^2                          = 0.9166
R^2 (adjusted)               = 0.9166
R^2 (prediction)             = 0.3453
Determinant of [X]'[X]       = 1.3973
    
```

Approximating Response 'Rigid\_Wall\_Force' using 10 points (ITERATION 1)

```

-----
                Global error parameters of response surface
-----
Quadratic Function Approximation:
-----
Mean response value          = 121662.9474

RMS error                    = 24730.1732 (20.33%)
Maximum Residual             = 48569.4162 (39.92%)
Average Error                 = 21111.3307 (17.35%)
Square Root PRESS Residual   = 75619.5531 (62.15%)
Variance                     = 1223162932.2092
R^2                          = 0.8138
R^2 (adjusted)               = 0.8138
R^2 (prediction)             = -0.7406
Determinant of [X]'[X]       = 1.3973
    
```

The initial design below shows that the constraint is severely exceeded.

DESIGN POINT

```

-----
Variable Name                Lower Bound  Value  Upper Bound
-----|-----|-----|-----
Radius                       20          75     100
Wall_Thickness                2           3       6
-----|-----|-----|-----
    
```

RESPONSE FUNCTIONS:

```

-----
|                Scaled                |                Unscaled                |
|-----|-----|-----|-----|
RESPONSE                       | Computed  Predicted | Computed  Predicted |
|-----|-----|-----|-----|
Internal_Energy                 | 1.296e+04 1.142e+04 | 1.296e+04 1.142e+04 |
Rigid_Wall_Force                | 1.749e+05 1.407e+05 | 1.749e+05 1.407e+05 |
-----|-----|-----|-----|
    
```

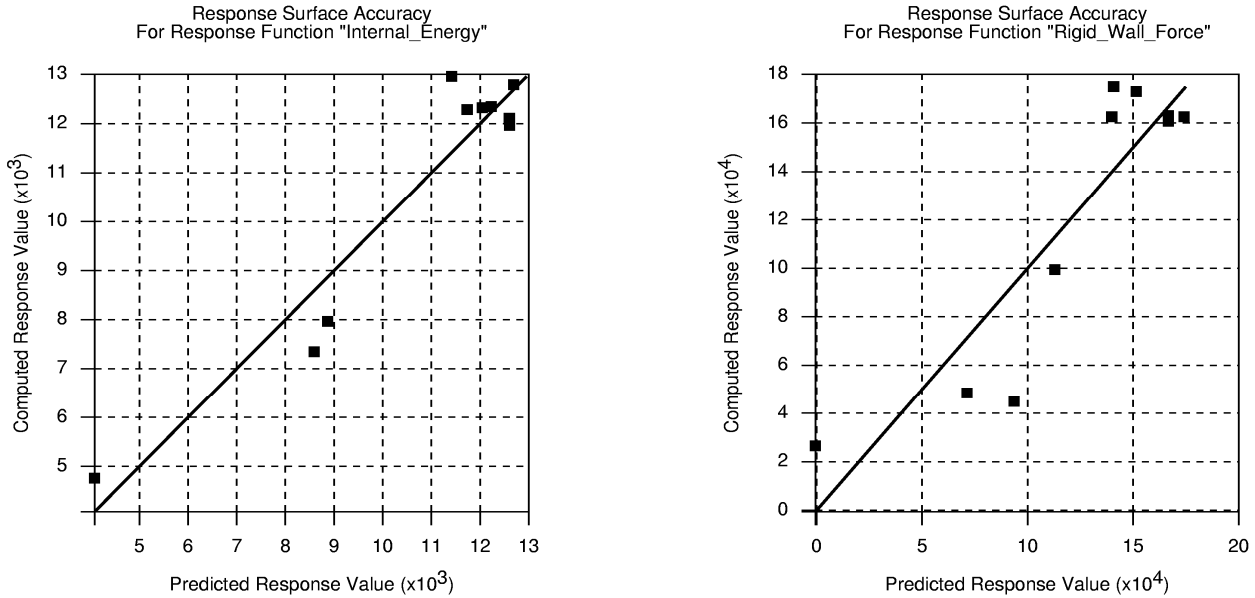


Figure 22-18: Prediction accuracy of Internal Energy and Rigid Wall Force (One Quadratic iteration)

Despite the relatively poor approximation a prediction of the optimum is made based on the approximation response surface. The results are shown below. The fact that the optimal Radius is on the lower bound of the subregion specified (Range = 50), suggests an optimal value below 50.

DESIGN POINT

Variable Name	Lower Bound	Value	Upper Bound
Radius	20	50	100
Wall_Thickness	2	2.978	6

RESPONSE FUNCTIONS:

RESPONSE	Scaled		Unscaled	
	Computed	Predicted	Computed	Predicted
Internal_Energy	7914	8778	7914	8778
Rigid_Wall_Force	4.789e+04	7e+04	4.789e+04	7e+04

### 22.3.3. Refining the design model using a second iteration

During the previous optimization step, the Radius variable was reduced from 75 to 50 (on the boundary of the region of interest). It was also apparent that the approximations were fairly inaccurate. Therefore, in the new iteration, the region of interest is reduced from [50;2] to [35;1.5] while retaining a quadratic approximation order. The starting point is taken as the current optimum: (50,2.978). The modified commands in the input file are as follows:



```

$
$ DESIGN VARIABLES
$
variables 2
Variable 'Radius' 50
  Lower bound variable 'Radius' 20
  Upper bound variable 'Radius' 100
  Range 'Radius' 35
Variable 'Wall_Thickness' 2.9783
  Lower bound variable 'Wall_Thickness' 2
  Upper bound variable 'Wall_Thickness' 6
  Range 'Wall_Thickness' 1.5

```

As shown below, the accuracy of fit improves but the average rigid wall force is still inaccurate.

Approximating Response 'Internal\_Energy' using 10 points (ITERATION 1)

-----  
Global error parameters of response surface  
-----

Quadratic Function Approximation:  
-----

Mean response value	=	8640.2050
RMS error	=	526.9459 (6.10%)
Maximum Residual	=	890.0759 (10.30%)
Average Error	=	388.4472 (4.50%)
Square Root PRESS Residual	=	1339.4046 (15.50%)
Variance	=	555344.0180
R <sup>2</sup>	=	0.9632
R <sup>2</sup> (adjusted)	=	0.9632
R <sup>2</sup> (prediction)	=	0.7622
Determinant of [X]'[X]	=	0.0556

Approximating Response 'Rigid\_Wall\_Force' using 10 points (ITERATION 1)

-----  
Global error parameters of response surface  
-----

Quadratic Function Approximation:  
-----

Mean response value	=	82483.2224
RMS error	=	19905.3990 (24.13%)
Maximum Residual	=	35713.1794 (43.30%)
Average Error	=	17060.6074 (20.68%)
Square Root PRESS Residual	=	54209.4513 (65.72%)
Variance	=	792449819.5138
R <sup>2</sup>	=	0.8949
R <sup>2</sup> (adjusted)	=	0.8949
R <sup>2</sup> (prediction)	=	0.2204
Determinant of [X]'[X]	=	0.0556

The goodness of fit diagrams are shown in Figure 22-19.

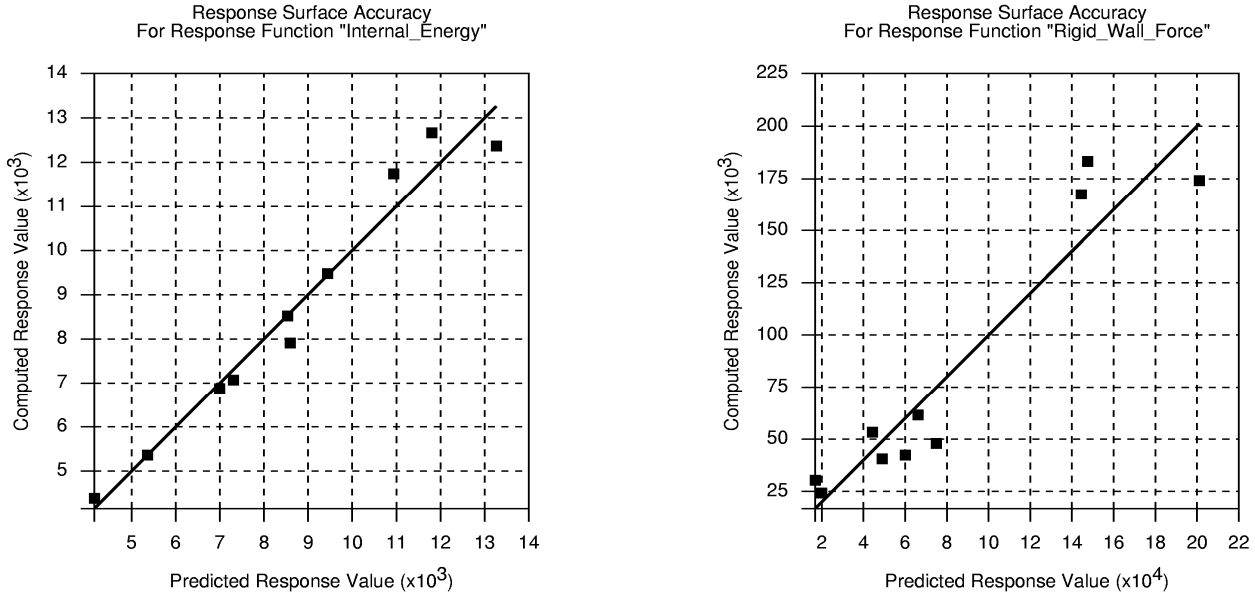


Figure 22-19: Prediction accuracy of Internal Energy and Rigid Wall Force (One Quadratic iteration)

Nevertheless an optimization is conducted of the approximate subproblem, yielding a much improved feasible result. The objective function increases to 9575 (9777 computed) whereas the constraint is active at 70 000. The computed constraint is lower at 64 170. However the `Wall_Thickness` is now on the upper bound, suggesting an optimal value larger than 3.728.

DESIGN POINT

Variable Name	Lower Bound	Value	Upper Bound
Radius	20	42.43	100
Wall_Thickness	2	3.728	6

RESPONSE FUNCTIONS:

RESPONSE	Scaled		Unscaled	
	Computed	Predicted	Computed	Predicted
Internal_Energy	9777	9575	9777	9575
Rigid_Wall_Force	6.417e+04	7e+04	6.417e+04	7e+04

22.3.4. Third iteration

Because of the large change in the `Wall_Thickness` on to the upper bound of the region of interest, a third iteration is conducted, keeping the region of interest the same. The starting point is the previous optimum:

Variable 'Radius' 42.43  
 Variable 'Wall\_Thickness' 3.728

The approximation improves as shown below:

Approximating Response 'Internal\_Energy' using 10 points (ITERATION 1)

-----  
Global error parameters of response surface  
-----

Quadratic Function Approximation:  
-----

Mean response value	=	9801.0070
RMS error	=	439.8326 (4.49%)
Maximum Residual	=	834.5960 (8.52%)
Average Error	=	372.3133 (3.80%)
Square Root PRESS Residual	=	1451.3233 (14.81%)
Variance	=	386905.5050
R <sup>2</sup>	=	0.9618
R <sup>2</sup> (adjusted)	=	0.9618
R <sup>2</sup> (prediction)	=	0.5842
Determinant of [X]'[X]	=	0.0131

Approximating Response 'Rigid\_Wall\_Force' using 10 points (ITERATION 1)

-----  
Global error parameters of response surface  
-----

Quadratic Function Approximation:  
-----

Mean response value	=	81576.0534
RMS error	=	12169.4703 (14.92%)
Maximum Residual	=	26348.0687 (32.30%)
Average Error	=	10539.2275 (12.92%)
Square Root PRESS Residual	=	37676.3033 (46.19%)
Variance	=	296192016.4365
R <sup>2</sup>	=	0.9301
R <sup>2</sup> (adjusted)	=	0.9301
R <sup>2</sup> (prediction)	=	0.3303
Determinant of [X]'[X]	=	0.0131

Because the size of the region of interest remained the same, the curve-fitting results show only a slight change (because of the new location), in this case an improvement. However, as the optimization results below show, the design is much improved, i.e. the objective value has increased whereas the approximate constraint is active. Unfortunately, due to the poor fit of the Rigid\_Wall\_Force, the simulation result exceeds the force constraint by about 10kN (14%). Further reduction of the region of interest is required to reduce the error, or filtering of the force can be considered to reduce the noise on this response.

DESIGN POINT

Variable Name	Lower Bound	Value	Upper Bound
Radius	20	36.51	100
Wall_Thickness	2	4.478	6

RESPONSE FUNCTIONS:

```

-----
|                               | Scaled          | Unscaled        |
|-----|-----|-----|-----|
RESPONSE | Computed | Predicted | Computed | Predicted |
|-----|-----|-----|-----|
Internal_Energy | 1.129e+04 | 1.075e+04 | 1.129e+04 | 1.075e+04 |
Rigid_Wall_Force | 8.007e+04 | 7e+04 | 8.007e+04 | 7e+04 |
-----

```

The table below gives a summary of the three iterations of the step-by-step procedure.

**Table 22-2: Comparison of results (Cylinder impact)**

Variable	Initial	Iteration 1	Iteration 2	Iteration 3
Radius	75	50	42.43	36.51
Wall thickness	3	2.978	3.728	4.478
Energy (Computed)	12960	7914	9777	11290
Force (Computed)	174900	47890	64170	80070

It is apparent that the result of the second iteration is a dramatic improvement on the starting design and a good approximation to the converged optimum design.

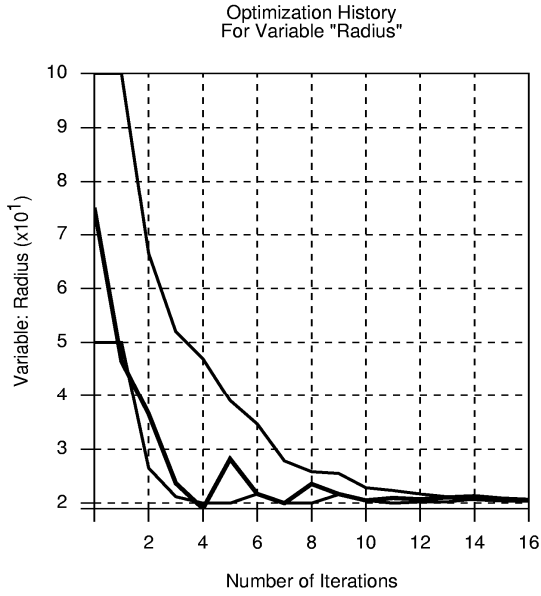
**22.3.5. Response filtering: using the peak force as a constraint**

Because of the poor accuracy of the response surface fit for the rigid wall force above, it was decided to modify the force constraint so that the peak filtered force is used instead. Therefore, the previous response definition for Rigid\_Wall\_Force is replaced with a command that extracts the *maximum* rigid wall force from a response from which frequencies exceeding 300Hz are excluded. The upper bound of the force constraint is changed to 80000.

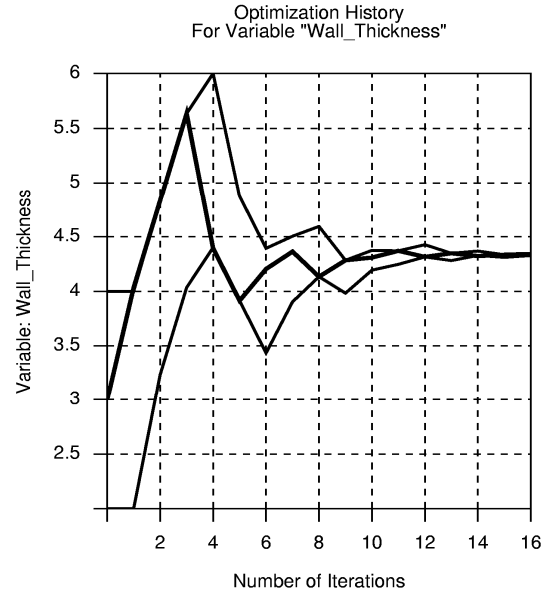
```
response 'Rigid_Wall_Force' "DynaASCII RWForc Normal 1 Max SAE 300"
```

20 iterations are specified with a 1% tolerance for convergence.

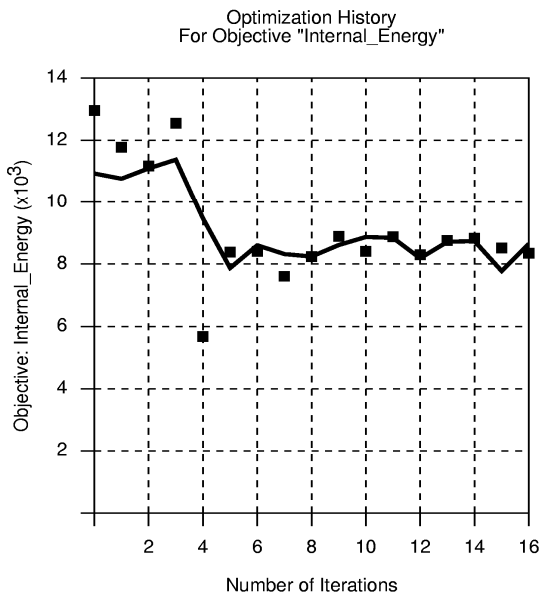
As expected, the response histories (Figure 22-20) show that the baseline design is severely infeasible (the first peak force is about  $1.75 \times 10^6$  vs. the constraint value of  $0.08 \times 10^6$ ). A steady reduction in the error of the response surfaces is observed up to about iteration 5. The optimization terminates after 16 iterations, having reached the 1% threshold for both objective and design variable changes.



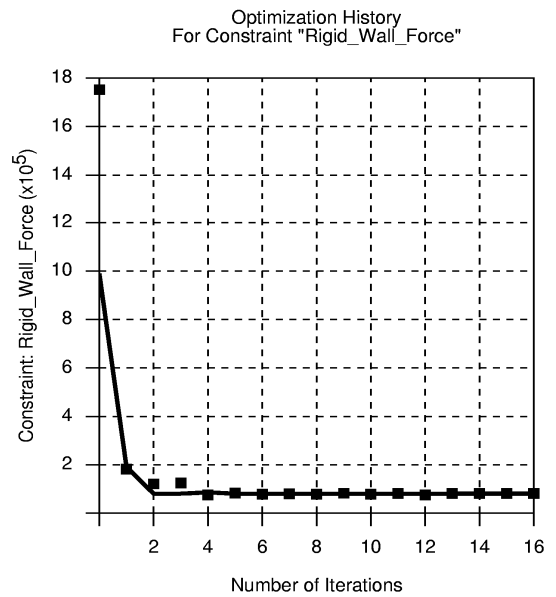
a) Radius



b) Wall\_Thickness



c) Internal\_Energy



d) Rigid\_Wall\_Force

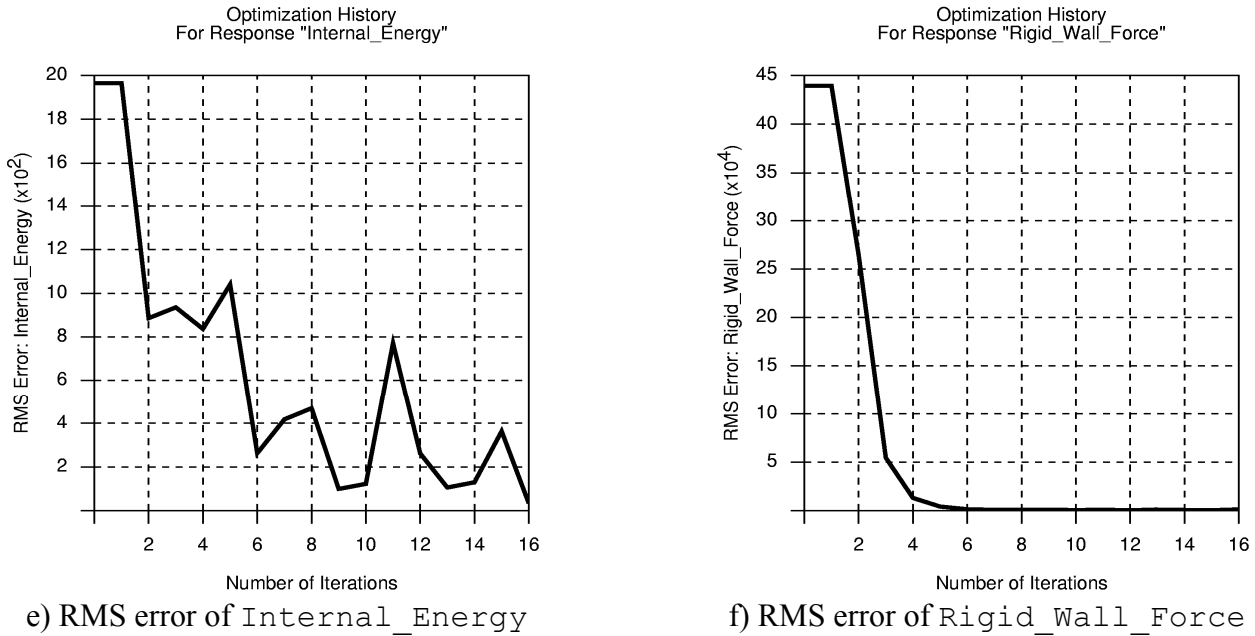


Figure 22-20: Optimization history of automated design (filtered force)

The optimization process steadily reduces the infeasibility, but the force constraint is still slightly violated when convergence is reached. The internal energy is significantly lower than previously:

```

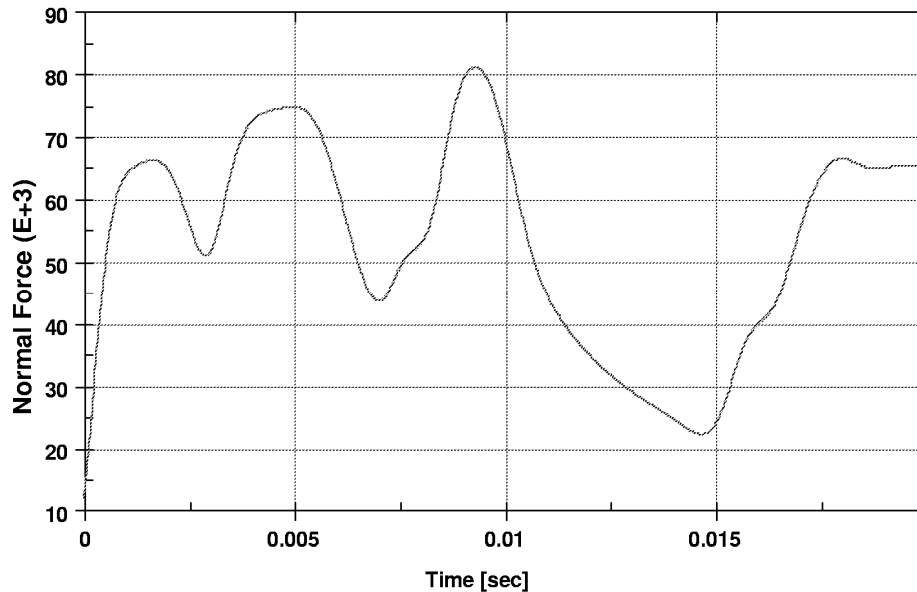
DESIGN POINT
-----
Variable Name          Lower Bound  Value  Upper Bound
-----|-----|-----|-----
Radius                 20          20.51   100
Wall_Thickness         2           4.342   6
-----|-----|-----|-----

RESPONSE FUNCTIONS:
-----

```

RESPONSE	Scaled		Unscaled	
	Computed	Predicted	Computed	Predicted
Internal_Energy	8344	8645	8344	8645
Rigid_Wall_Force	8.112e+04	8e+04	8.112e+04	8e+04

Figure 22-21 below confirms that the final design is only slightly infeasible when the maximum filtered force exceeds the specified limit for a short duration at around 9ms.



*Figure 22-21: Cylinder: Constrained rigid wall force:  $F(t) < 80000$  (SAE 300Hz filtered)*

## 22.4. Sheet-metal forming (3 variables)

A sheet-metal forming example in which the design involves thinning and FLD criteria is demonstrated in this chapter. The example has the following features:

The maximum of all the design variables is minimized.

Adaptive meshing is used in the finite element analysis.

The binary LS-DYNA database is used.

The example employs the sheet metal forming interface utilities.

Composite functions are used.

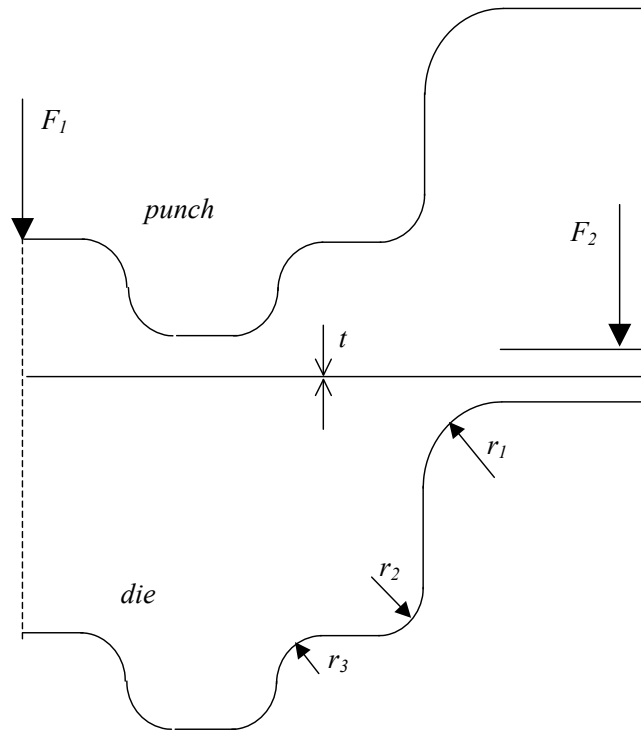
An appended file containing extra input is used.

The example utilizes the independent parametric preprocessor, Truegrid<sup>15</sup>.

### 22.4.1. Problem statement

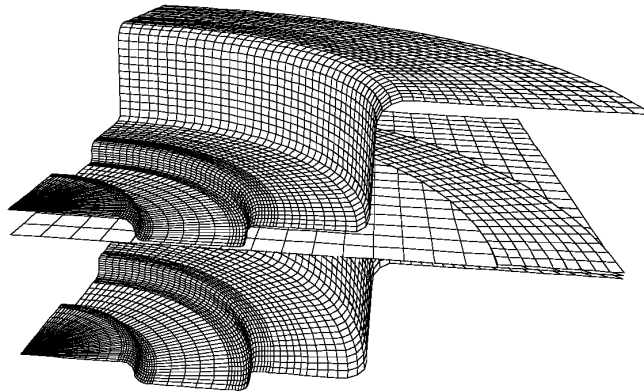
The design parameterization for the sheet metal forming example is shown in Figure 22-22.

<sup>15</sup> Registered Trademark of XYZ Scientific Applications Inc.



**Figure 22-22: Parameterization of cross-section**

The FE model is shown in Figure 22-23.



**Figure 22-23: Quarter segment of FE model: tools and blank**

The design problem is formulated to minimize the maximum tool radius while also specifying an FLD constraint and a maximum thickness reduction of 20% (thinning constraint). Since the user wants to enforce the FLD and thinning constraints strictly, these constraints are defined as `strict`. To minimize the maximum radius, a small upper bound for the radii has been specified (arbitrarily chosen as a number close



to the lower bound of the design space, namely 1.1). The optimization solver will then minimize the maximum difference between the radii and their respective bounds. The radius constraints must not be enforced strictly. This translates to the following mathematical formulation:

Minimize  $e$

with

$$1.5 \leq r_1 \leq 4.5$$

$$1.5 \leq r_2 \leq 4.5$$

$$1.5 \leq r_3 \leq 4.5$$

subject to

$$g^{FLD}(\mathbf{x}) < 0.0$$

$$\Delta t(\mathbf{x}) < 20\%$$

$$r_1 - 1.1 < e$$

$$r_2 - 1.1 < e$$

$$r_3 - 1.1 < e$$

$$e > 0.$$

The design variables  $r_1$ ,  $r_2$  and  $r_3$  are the radii of the work piece as indicated in Figure 22-22.  $\Delta t$  is the thickness reduction which is positive when the thickness is reduced. The FLD constraint is feasible when smaller than zero.

### 22.4.2. First Iteration

The initial run is a quadratic analysis designed as an initial investigation of the following issues:

The dependency of the through thickness strain constraint on the radii.

The dependency of the FLD constraint on the radii.

The location of the optimal design point.

The subregion considered for this study is 2.0 large in  $r_1$ ,  $r_2$  and  $r_3$  and is centered about  $(1.5, 1.5, 1.5)^T$ . The FLD constraint formulation tested in this phase is based on the maximum perpendicular distance of a point violating the FLD constraint to the FLD curve (see Section 14.9.2).

The LS-OPT command file used to run the problem is:

```
"Sheet: Minimization of Maximum Tool Radius"
Author "Aaron Spelling"
$ Created on Wed May 29 19:23:20 2002
$
```

```

$ DESIGN VARIABLES
$
variables 3
  Variable 'Radius_1' 1.5
    Lower bound variable 'Radius_1' 1
    Upper bound variable 'Radius_1' 4.5
    Range 'Radius_1' 4
  Variable 'Radius_2' 1.5
    Lower bound variable 'Radius_2' 1
    Upper bound variable 'Radius_2' 4.5
    Range 'Radius_2' 4
  Variable 'Radius_3' 1.5
    Lower bound variable 'Radius_3' 1
    Upper bound variable 'Radius_3' 4.5
    Range 'Radius_3' 4
solvers 1
responses 2
$
$ NO HISTORIES ARE DEFINED
$
$
$ DEFINITION OF SOLVER "DYNA1"
$
  solver dyna 'DYNA1'
  solver command "lsdyna"
  solver input file "trugrdo"
  solver append file "ShellSetList"
  prepro truegrid
  prepro command "/net/src/ultra4_4/common/hp/tg2.1/tg"
  prepro input file "m3.tg.opt"
$
$ RESPONSES FOR SOLVER "DYNA1"
$
  response 'Thinning' 1 0 "DynaThick REDUCTION MAX"
  response 'Thinning' linear
  response 'FLD' 1 0 "DynaFLDg CENTER 1 2 3 90"
  response 'FLD' linear
$
$ NO HISTORIES DEFINED FOR SOLVER "DYNA1"
$
$
$ HISTORIES AND RESPONSES DEFINED BY EXPRESSIONS
$
  composites 4
  composite 'Rad1' type weighted
    composite 'Rad1' variable 'Radius_1' 1 scale 1
  composite 'Rad2' type weighted
    composite 'Rad2' variable 'Radius_2' 1 scale 1
  composite 'Rad3' type weighted
    composite 'Rad3' variable 'Radius_3' 1 scale 1
  composite 'Thinning_scaled' {Thinning/100}
$
$ NO OBJECTIVES DEFINED
$
  objectives 0
$
$ CONSTRAINT DEFINITIONS

```

```

$
constraints 5
constraint 'FLD'
  strict
  upper bound constraint 'FLD' 0.0
constraint 'Rad1'
  slack
  upper bound constraint 'Rad1' 1.1
constraint 'Rad2'
  upper bound constraint 'Rad2' 1.1
constraint 'Rad3'
  upper bound constraint 'Rad3' 1.1
constraint 'Thinning_scaled'
  strict
  upper bound constraint 'Thinning_scaled' 0.2
$
$ EXPERIMENTAL DESIGN
$
Order quadratic
Experimental design dopt
Basis experiment 3toK
Number experiment 16
$
$ JOB INFO
$
concurrent jobs 8
iterate param design 0.01
iterate param objective 0.01
iterate 1
STOP

```

The file `ShellSetList` contains commands for LS-DYNA in addition to the preprocessor output. It is slotted into the input file. Adaptive meshing is chosen as an analysis feature for the simulation. The FLD curve data is also specified in this file. The extra commands are:

```

*DATABASE_BINARY_RUNRSF
70
*DATABASE_EXTENT_BINARY
0, 0, 0, 1, 0, 0, 0, 1
0, 0, 0, 0, 0, 0
$
$ SLIDING INTERFACE DEFINITIONS
$
$ TrueGrid Sliding Interface # 1
$
*CONTACT_FORMING_ONE_WAY_SURFACE_TO_SURFACE
$ workpiece vs punch
0.1000000      1          2          3          3          0.000  0.000          1
              0.0
$
*CONTACT_FORMING_ONE_WAY_SURFACE_TO_SURFACE
$ workpiece vs die
              1          3          3          3          0.000  0.000          1
0.1000000      1
              0.0
$

```

```

*CONTACT_FORMING_ONE_WAY_SURFACE_TO_SURFACE
$ workpiece vs blankholder
1          1          4          3          3
1          0.1000000          0.000          0.000
          0.0
$
*CONTROL_ADAPTIVE
$ ADPFREQ ADPTOL ADPOPT MAXLVL TBIRTH TDEATH LCADP IOFLAG
0.100E-03 5.000 2 3 0.000E+00 1.0000000 0 1
$ ADPSIZE ADPASS IREFLG ADPENE
0.0000000 1 0 3.0000
*LOAD_RIGID_BODY
$ rbID dir lcID scale
2 3 2 1.0000000
*LOAD_RIGID_BODY
$ rbID dir lcID scale
4 3 3 1.0000000
*DEFINE_CURVE
$ FLD curve
90
$
-1,2.083
0,.25
1,.75
*END

```

The input file (file m3.tg.opt) used to generate the FE mesh in Truegrid is:

```

c generate LS-DYNA input deck for sheet metal example
lsdyna keyword
lsdyopts endtim .0009 nodout 1.e-6 d3plot dtcycl .0001 ; ;
lsdyopts istupd 1 ;
c lsdymats 1 37 shell elfor bt rho 7.8e-9 e 2.e5 pr .28
c sigy 200. etan 572 er 1.4 ;
lsdymats 2 20 shell elfor bt rho 7.8e-9 e 2.e5 pr .28 shth .1
cmo con 4 7;
lsdymats 3 20 shell elfor bt rho 7.8e-9 e 2.e5 pr .28 shth .1
cmo con 7 7 ;
lsdymats 4 20 shell elfor bt rho 7.8e-9 e 2.e5 pr .28 shth .1
cmo con 4 7;
plane 2 0 0 0 1 0 0 .01 symm ;
plane 3 0 0 0 0 1 0 0.01 symm ;
c sid 1 lsdsl a10 slvmat 1;mstmat 2;scoef .1 ; ; ;
c sid 2 lsdsl a10 slvmat 1;mstmat 3;scoef .1 ; ; ;
c sid 3 lsdsl a10 slvmat 1;mstmat 4;scoef .1 ; ; ;
c
lcd 1
0.000000000E+00 0.275600006E+03
0.665699990E-04 0.276100006E+03
0.136500006E-03 0.276700012E+03
.
.
.
0.312799990E+00 0.481799988E+03
0.469900012E+00 0.517200012E+03
0.705600023E+00 0.555299988E+03
;

```

```

c
c die cross-section
para
c
  r1 <<Radius_1>> c upper radius  minimum = 2.
  r2 <<Radius_2>> c middle radius  minimum = 2.
  r3 <<Radius_3>> c lower radius   minimum = 2.
  load2 -100000
  load3 -20000
  th1 1.0          c thickness of blank
  th3 .00          c thickness of die and punch
  th2 [1.001*%th1]
  l1 20           c length of draw (5-40)
c
  z5 [%l1-22]
c Position of workpiece
  z4 [%z5+1.001*%th1/2.+%th3/2]
c Position of blankholder
  z3 [%z4+1.001*%th1/2.+%th3/2]
  n1 [25+4.0*%l1]
  n2 [25+8.0*%l1]
c part 2
  z6 [%z5+4+%th2]
  z7 [%z5+%l1+4+%th2]
;
c
c die cross-section

  .
  .
  .
  c punch cross-section (closed configuration)
ld 2
  lod 1 [%th2+%th3]

c punch cross-section (withdrawn configuration)
ld 3 lst1 2 0 [%z5+26]

  .
  .
  .

endpart
c ***** part 2 mat 2 ***** punch
cylinder
1 8 35 40 67 76 [76+%n1] [70+%n1+10]; 1 41 ; -1 ;
.001 17. 23. 36. 44. 50. 75. 100.
0. 90.
%z7

  .
  .
  .

thick %th3
mate 2
endpart

```

```

c ***** part 3 mat 4 ***** blankholder
cylinder
1 10 ; 1 41 ; -1 ;
80. 100.
0. 90.
[%z3]
b 0 0 0 0 0 0 dx 1 dy 1 rx 1 ry 1 rz 1;
thick %th3
mate 4
endpart

c ***** part 4 mat 1 workpiece
block
1 21 ; 1 21 ; -1 ;
0. 100.
0. 100.
[%z4]
thick [%th1]
mate 1
endpart
merge
write
end

```

The error parameters for the fitted functions are given in the following output (from `lsopt_output` file):

Approximating Response 'Thinning' using 16 points (ITERATION 1)

-----  
Global error parameters of response surface  
-----

Quadratic Function Approximation:  
-----

Mean response value	=	27.8994
RMS error	=	0.6657 (2.39%)
Maximum Residual	=	1.2932 (4.64%)
Average Error	=	0.5860 (2.10%)
Square Root PRESS Residual	=	2.0126 (7.21%)
Variance	=	1.0130
R <sup>2</sup>	=	0.9913
R <sup>2</sup> (adjusted)	=	0.9826
R <sup>2</sup> (prediction)	=	0.9207
Determinant of [X]'[X]	=	2231.5965

Approximating Response 'FLD' using 16 points (ITERATION 1)

-----  
Global error parameters of response surface  
-----

Quadratic Function Approximation:  
-----

Mean response value	=	0.0698
RMS error	=	0.0121 (17.33%)

```

Maximum Residual      =      0.0247 (35.35%)
Average Error         =      0.0103 (14.74%)
Square Root PRESS Residual =    0.0332 (47.59%)
Variance              =      0.0003
R^2                  =      0.9771
R^2 (adjusted)       =      0.9542
R^2 (prediction)     =      0.8272
Determinant of [X]'[X] = 2231.5965
    
```

The thinning has a reasonably accurate response surface but the FLD approximation requires further refinement. The initial design has the following response surface results which fail the criteria for maximum thinning, but not for FLD:

```

DESIGN POINT
-----
Variable Name          Lower Bound   Value      Upper Bound
-----
Radius_1              1           1.5       4.5
Radius_2              1           1.5       4.5
Radius_3              1           1.5       4.5
-----

CONSTRAINT FUNCTIONS:
-----
CONSTRAINT NAME       | Computed | Predicted | Lower | Upper | Viol?
-----
FLD                   | 0.09123  | 0.1006   | -1e+30 |      0 | YES
Rad1                  | 1.5      | 1.5      | -1e+30 | 1.1 | YES
Rad2                  | 1.5      | 1.5      | -1e+30 | 1.1 | YES
Rad3                  | 1.5      | 1.5      | -1e+30 | 1.1 | YES
Thinning_scaled      | 0.2957   | 0.3078   | -1e+30 | 0.2 | YES
-----

CONSTRAINT VIOLATIONS:
-----
CONSTRAINT NAME       | Computed Violation | Predicted Violation |
-----
| Lower | Upper | Lower | Upper |
-----
FLD                   | -      | 0.09123 | -      | 0.1006 |
Rad1                  | -      | 0.4     | -      | 0.4     |
Rad2                  | -      | 0.4     | -      | 0.4     |
Rad3                  | -      | 0.4     | -      | 0.4     |
Thinning_scaled      | -      | 0.09567 | -      | 0.1078 |
-----
    
```

As shown below, after 1 iteration, a feasible design is generated. The simulation response of the optimum is closely approximated by the response surface.

```

DESIGN POINT
-----
Variable Name          Lower Bound   Value      Upper Bound
-----
Radius_1              1           3.006     4.5
Radius_2              1           3.006     4.5
Radius_3              1           3.006     4.5
-----

CONSTRAINT FUNCTIONS:
-----
CONSTRAINT NAME       | Computed | Predicted | Lower | Upper | Viol?
-----
FLD                   | -0.04308 | -0.03841 | -1e+30 |      0 | no
    
```

Rad1	3.006	3.006	-1e+30	1.1	YES
Rad2	3.006	3.006	-1e+30	1.1	YES
Rad3	3.006	3.006	-1e+30	1.1	YES
Thinning_scaled	0.2172	0.2	-1e+30	0.2	no

-----

CONSTRAINT VIOLATIONS:

-----

CONSTRAINT NAME	Computed Violation		Predicted Violation	
	Lower	Upper	Lower	Upper
FLD	-	-	-	-
Rad1	-	1.906	-	1.906
Rad2	-	1.906	-	1.906
Rad3	-	1.906	-	1.906
Thinning_scaled	-	0.01718	-	-

-----

### 22.4.3. Automated design

The optimization process can also be automated so that no user intervention is required. The starting design, lower and upper bounds, and region of interest is modified from the 1 iteration study above.

The input file is modified as follows:

The variable definitions are as follows:

```
Variable 'Radius_1' 1.5
  Lower bound variable 'Radius_1' 1
  Upper bound variable 'Radius_1' 4.5
  Range 'Radius_1' 1
Variable 'Radius_2' 1.5
  Lower bound variable 'Radius_2' 1
  Upper bound variable 'Radius_2' 4.5
  Range 'Radius_2' 1
Variable 'Radius_3' 1.5
  Lower bound variable 'Radius_3' 1
  Upper bound variable 'Radius_3' 4.5
  Range 'Radius_3' 1
```

The number of *D*-optimal experiments is reduced because of the linear approximation used:

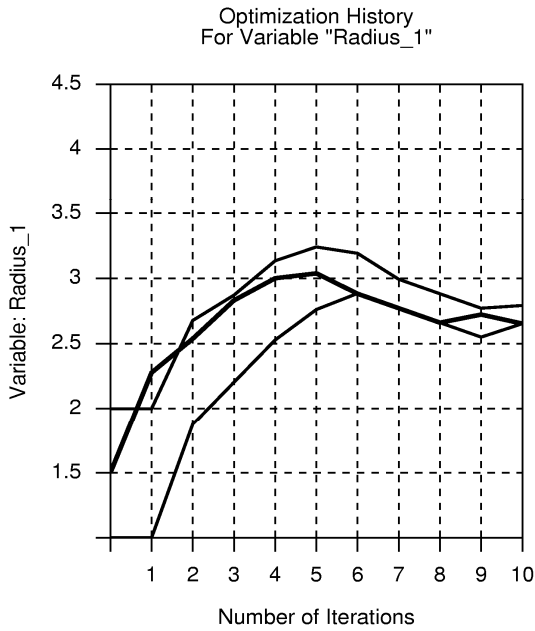
```
Order linear
Experimental design dopt
Basis experiment 3toK
Number experiment 7
```

The optimization is run for 10 iterations:

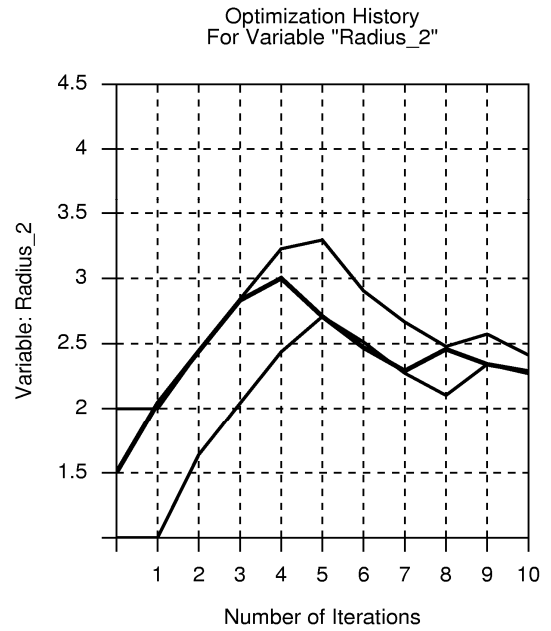
```
iterate 10
```



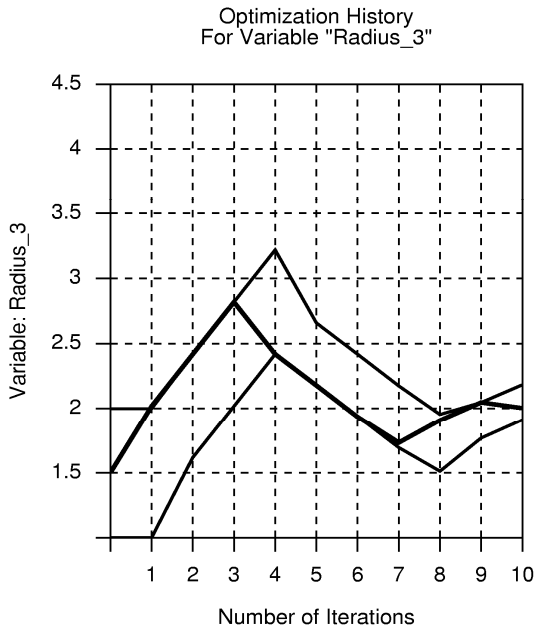
The optimization history is shown in Figure 22-24 for the design variables and responses:



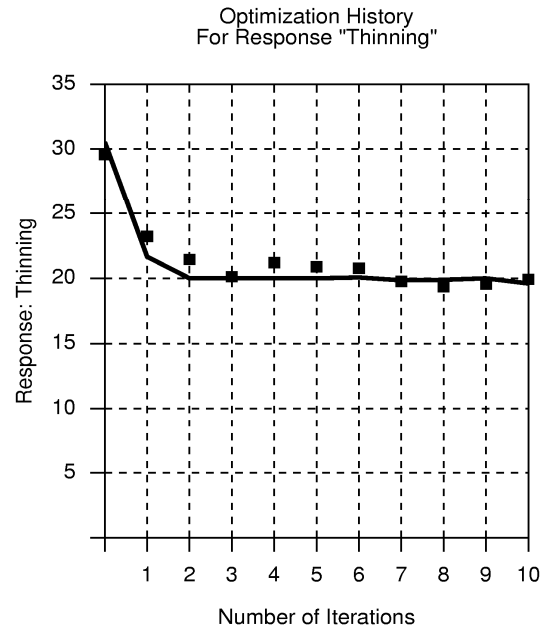
a) Optimization history of variable 'Radius\_1'



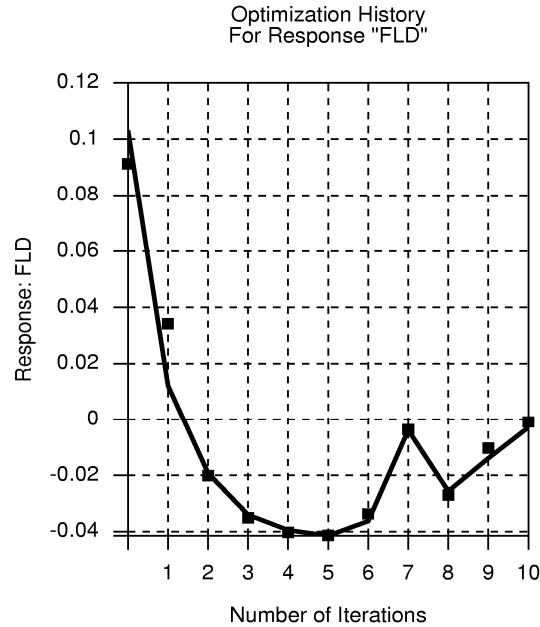
b) Optimization history of variable 'Radius\_2'



c) Optimization history of variable 'Radius\_3'



d) Optimization history of response 'Thinning'



e) Optimization history of response FLD

**Figure 22-24: Optimization history of design variables and responses (automated design)**

The details of the 10<sup>th</sup> iteration have been extracted:

```

DESIGN POINT
-----
Variable Name          Lower Bound   Value        Upper Bound
-----|-----|-----|-----
Radius_1                1             2.653         4.5
Radius_2                1             2.286         4.5
Radius_3                1             2.004         4.5
-----|-----|-----|-----

RESPONSE FUNCTIONS:
-----

```

RESPONSE	Scaled		Unscaled	
	Computed	Predicted	Computed	Predicted
Thinning	19.92	19.6	19.92	19.6
FLD	-0.000843	-0.002907	-0.000843	-0.002907

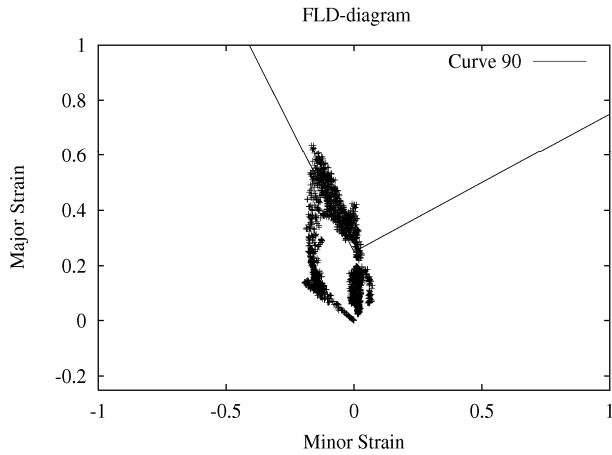
A comparison between the starting and the final values is tabulated below:

**Table 22-3: Comparison of results (Sheet-metal forming)**

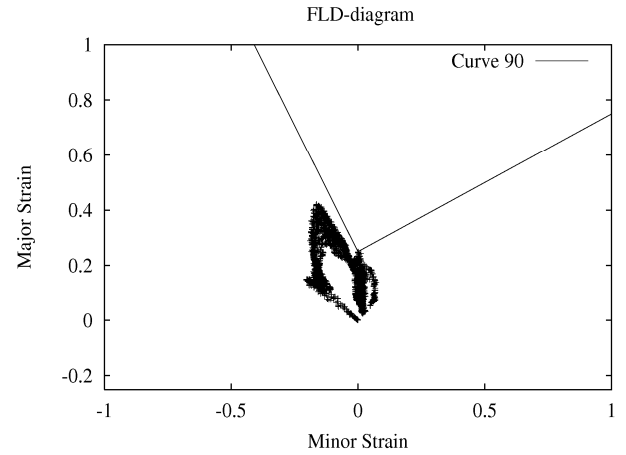
Variable	Start (Computed)	Optimal (Predicted)	Optimal (Computed)
----------	------------------	---------------------	--------------------

Thinning	29.57	19.92	19.6
FLD	0.09123	-0.000843	-0.002907
Radius_1	1.5	2.653	
Radius_2	1.5	2.286	
Radius_3	1.5	2.004	

The FLD diagrams (Figure 22-25) for the baseline design and the optimum illustrate the improvement of the FLD feasibility:



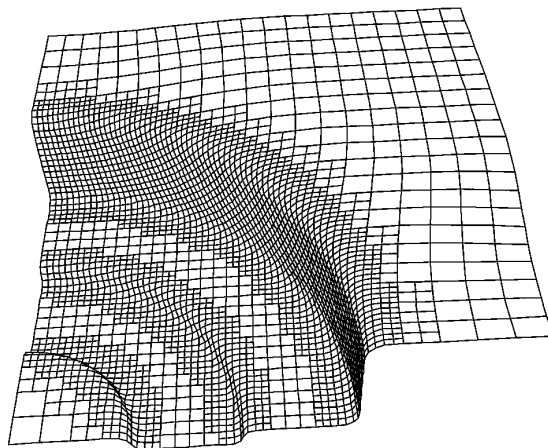
Baseline FLD diagram



FLD diagram of 10<sup>th</sup> iteration

**Figure 22-25: FLD diagrams of baseline and 10<sup>th</sup> iteration**

A typical deformed state is depicted in Figure 22-26 below.



**Figure 22-26: Deformed state**

## 22.5. System identification (elastoplastic material) (2 variables)

A methodology for deriving system or material parameters from experimental results, known as system identification, is applied here using optimization. The example has the following features:

The `MeanSqErr` composite function is used

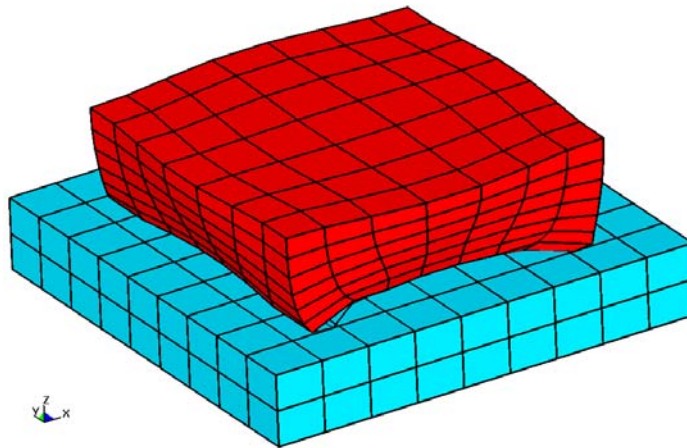
The `Crossplot` history is used

The Min-Max formulation is demonstrated

Multiple test cases are employed

The confidence intervals of the optimal parameters is reported.

### 22.5.1. Problem statement



**Figure 22-27: Sample of elastoplastic material subjected to a controlled vertical displacement**

The material parameters of a foam material must be determined from experimental results, namely the resultant reaction force vs. displacement history of a cubic sample on a rigid base (see Figure 22-27). The problem is solved by minimizing the mean squared residual force (`rcforc` binary database) with the material parameters Young's modulus  $E$  and Yield stress  $Y$  as the unknown optimization variables.

The “experimental” resultant forces vs. displacements are shown below. The results were generated from an LS-DYNA run with the parameters ( $E = 10^6$ ,  $Y = 10^3$ ). Samples are taken at times 2, 4, 6 and 8 ms:

#### **Test1.txt**

```
0.36168 10162
0.72562 12964
1.0903 14840
1.4538 17672
```

**Test2.txt**

```

0.36168 17393
0.72562 19559
1.0903 22098
1.4538 26833

```

The finite element models for the two cases are represented in the keyword files foam1.k and foam2.k respectively.

**22.5.2. Ordinate-based Curve Matching**

The LS-OPT command file is given below. The displacement and force histories are used to construct a force vs. displacement crossplot for the two cases. The mean squared residual error (MSE) between each crossplot and the corresponding test data is then computed. The two MSE values are simply added to find the objective value. Although only four test points are given for each case, 10 points at constant intervals are interpolated for use in the `MeanSqErr` (Section 15.6.1) composite:

$$\varepsilon = \frac{1}{P} \sum_{p=1}^P W_p \left( \frac{f_p(\mathbf{x}) - G_p}{s_p} \right)^2 = \frac{1}{P} \sum_{p=1}^P W_p \left( \frac{e_p(\mathbf{x})}{s_p} \right)^2$$

where  $P=10$ ,  $s_p = 1$  and  $W_p = 1$ . The representative MSE command is:

```

composite 'MSE1' { MeanSqErr ( Test1, Force_vs_Displ, 10 ) }
"Example 6"
$ Created on Mon Nov 28 10:42:41 2005
solvers 2
$
$ WARNING -- NO RESPONSES ARE DEFINED
$
histories 8
$
$ DESIGN VARIABLES
$
variables 2
Variable 'Youngs_Modulus' 700000
  Lower bound variable 'Youngs_Modulus' 500000
  Upper bound variable 'Youngs_Modulus' 2e+06
  Local 'Youngs_Modulus'
Variable 'Yield_Stress' 1500
  Lower bound variable 'Yield_Stress' 500
  Upper bound variable 'Yield_Stress' 2000
$
$ CONSTANTS
$
constants 3
Constant 'Begin' 0.002
Constant 'End' 0.008
Constant 'numpoints' 4
$$$$$$$$$$$$$$$$$$$$$$$$$$$$$$$$$$$$$$$$

```

```

$      OPTIMIZATION METHOD
$$$$$$$$$$$$$$$$$$$$$$$$$$$$$$$$$$$$$$$$
$
Optimization Method SRSM

$$$$$$$$$$$$$$$$$$$$$$$$$$$$$$$$$$$$$$$$
$      SOLVER "Case1"
$$$$$$$$$$$$$$$$$$$$$$$$$$$$$$$$$$$$$$$$
$
$ DEFINITION OF SOLVER "Case1"
$
  solver dyna960 'Case1'
  solver command "ls970.single"
  solver input file "foam1.k"
$ ----- Pre-processor -----
$   NO PREPROCESSOR SPECIFIED
$ ----- Sampling -----
  solver order linear
  solver experiment design dopt
  solver basis experiment 5toK
$ ----- Job information -----
  solver concurrent jobs 1
$
$ WARNING - NO RESPONSES DEFINED FOR SOLVER "Case1"
$
$
$ HISTORIES FOR SOLVER "Case1"
$
  history 'Force1' "BinoutHistory -res_type rcforc -cmp z_force -id 1 -side SLAVE"
  history 'Disp1' "BinoutHistory -res_type nodout -cmp z_displacement -id 296"
$
$ HISTORY EXPRESSIONS FOR SOLVER "Case1"
$
  history 'Force_vs_Displ1' expression { Crossplot ("-Disp1", "Force1") }

$$$$$$$$$$$$$$$$$$$$$$$$$$$$$$$$$$$$$$$$
$      SOLVER "Case2"
$$$$$$$$$$$$$$$$$$$$$$$$$$$$$$$$$$$$$$$$
$
$ DEFINITION OF SOLVER "Case2"
$
  solver dyna960 'Case2'
  solver command "ls970.single"
  solver input file "foam2.k"
$ ----- Pre-processor -----
$   NO PREPROCESSOR SPECIFIED
$ ----- Sampling -----
  solver order linear
  solver experiment design dopt
  solver basis experiment 5toK
$ ----- Job information -----
  solver concurrent jobs 1
$
$ LOCAL DESIGN VARIABLES FOR SOLVER "Case2"
$
  solver variable 'Youngs_Modulus'
$
$ WARNING - NO RESPONSES DEFINED FOR SOLVER "Case2"
$
$
$ HISTORIES FOR SOLVER "Case2"
$
  history 'Force2' "BinoutHistory -res_type rcforc -cmp z_force -id 1 -side SLAVE"
  history 'Disp2' "BinoutHistory -res_type nodout -cmp z_displacement -id 288"
$
$ HISTORY EXPRESSIONS FOR SOLVER "Case2"
$
  history 'Force_vs_Displ2' expression { Crossplot ("-Disp2", "Force2") }

$
$ HISTORIES FROM FILES

```

```

$
  history 'Test1' file "Test1.txt"
  history 'Test2' file "Test2.txt"
composites 3
$
$ COMPOSITE EXPRESSIONS
$
  composite 'MSE1' { MeanSqErr ( Test1, Force_vs_Displ, 10 ) }
  composite 'MSE2' { MeanSqErr ( Test2, Force_vs_Displ2, 10 ) }
  composite 'MSE' { sqrt(MSE1 + MSE2) }
$
$ OBJECTIVE FUNCTIONS
$
  objectives 2
  objective 'MSE1' 1
  objective 'MSE2' 1
$
$ THERE ARE NO CONSTRAINTS!!!
$
  constraints 0
$
$ JOB INFO
$
  concurrent jobs 1
  iterate param design 0.01
  iterate param objective 0.01
  iterate param stoppingtype and
  iterate 2
STOP

```

### 22.5.3. Maximum residual formulation

In this formulation, the deviations from the respective target values are incorporated as constraint violations, so that the optimization problem for parameter identification becomes:

Minimize  $e$ ,

subject to

$$\left| \frac{f_j(\mathbf{x}) - G_j}{s_j} \right| \leq e; \quad j = 1, \dots, 8$$

$$e \geq 0$$

This formulation is automatically activated in LS-OPT by specifying the individual responses in equality constraints, i.e. without specifying the objective function as the maximum constraint violation. This is due to the fact LS-OPT automatically minimizes the infeasibility  $e$ , ignoring the objective function until a feasible design is found. When used in parameter identification, all the constraints are in general never completely satisfied due to typically over-determined systems that are used and therefore the objective function specification may be omitted.

As a method of second choice, the Minmax method presently requires a more laborious input preparation than the MSE approach. It will be simplified, using a single command, in a later version of LS-OPT.

"Example 6c"

```

$ Created on Sun Apr  4 18:00:20 2004
solvers 2
responses 8
histories 2
$
$ DESIGN VARIABLES
$
variables 2
Variable 'Youngs_Modulus' 700000
  Lower bound variable 'Youngs_Modulus' 500000
  Upper bound variable 'Youngs_Modulus' 2e+06
Variable 'Yield_Stress' 1500
  Lower bound variable 'Yield_Stress' 500
  Upper bound variable 'Yield_Stress' 2000

$$$$$$$$$$$$$$$$$$$$$$$$$$$$$$$$$$$$$$$$$$$$
$ OPTIMIZATION METHOD
$$$$$$$$$$$$$$$$$$$$$$$$$$$$$$$$$$$$$$$$$$$$
$
Optimization Method SRSM

$$$$$$$$$$$$$$$$$$$$$$$$$$$$$$$$$$$$$$$$$$$$
$ SOLVER "Case1"
$$$$$$$$$$$$$$$$$$$$$$$$$$$$$$$$$$$$$$$$$$$$
$
$ DEFINITION OF SOLVER "Case1"
$
solver dyna960 'Case1'
  solver command "ls970.single"
  solver input file "foam1.k"
  solver order linear
  solver experiment design dopt
  solver number experiments 5
  solver basis experiment 3toK
  solver concurrent jobs 1
$
$ WARNING - NO RESPONSES DEFINED FOR SOLVER "Case1"
$
$
$ HISTORIES FOR SOLVER "Case1"
$
history 'Forcel' "BinoutHistory -res_type rcforc -cmp z_force -id 1 -side SLAVE "
$
$ RESPONSE EXPRESSIONS FOR SOLVER "Case1"
$
response 'F1_1' expression {Forcel(0.002)}
response 'F2_1' expression {Forcel(0.004)}
response 'F3_1' expression {Forcel(0.006)}
response 'F4_1' expression {Forcel(0.008)}

$$$$$$$$$$$$$$$$$$$$$$$$$$$$$$$$$$$$$$$$$$$$
$ SOLVER "Case2"
$$$$$$$$$$$$$$$$$$$$$$$$$$$$$$$$$$$$$$$$$$$$
$
$ DEFINITION OF SOLVER "Case2"
$
solver dyna960 'Case2'
  solver command "ls970.single"
  solver input file "foam2.k"
  solver order linear
  solver experiment duplicate 'Case1'
  solver concurrent jobs 1
$
$ WARNING - NO RESPONSES DEFINED FOR SOLVER "Case2"
$
$
$ HISTORIES FOR SOLVER "Case2"
$
history 'Force2' "BinoutHistory -res_type rcforc -cmp z_force -id 1 -side SLAVE "
$
$ RESPONSE EXPRESSIONS FOR SOLVER "Case2"

```



```

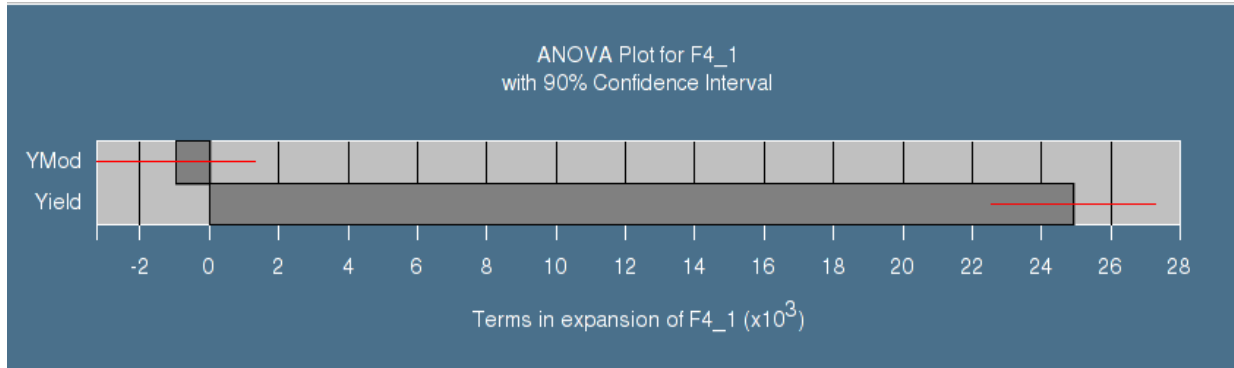
$
response 'F1_2' expression {Force2(0.002)}
response 'F2_2' expression {Force2(0.004)}
response 'F3_2' expression {Force2(0.006)}
response 'F4_2' expression {Force2(0.008)}

composites 1
$
$ COMPOSITE RESPONSES
$
composite 'Residual' type targeted
  composite 'Residual' response 'F1_1' 10162 scale 1
    weight 1
  composite 'Residual' response 'F2_1' 12964 scale 1
    weight 1
  composite 'Residual' response 'F3_1' 14840 scale 1
    weight 1
  composite 'Residual' response 'F4_1' 17672 scale 1
    weight 1
  composite 'Residual' response 'F1_2' 17393 scale 1
    weight 1
  composite 'Residual' response 'F2_2' 19559 scale 1
    weight 1
  composite 'Residual' response 'F3_2' 22098 scale 1
    weight 1
  composite 'Residual' response 'F4_2' 26833 scale 1
    weight 1
$
$ NO OBJECTIVES DEFINED
$
objectives 0
$
$ CONSTRAINT DEFINITIONS
$
constraints 8
constraint 'F1_1'
  lower bound constraint 'F1_1' 10162
  upper bound constraint 'F1_1' 10162
constraint 'F2_1'
  lower bound constraint 'F2_1' 12964
  upper bound constraint 'F2_1' 12964
constraint 'F3_1'
  lower bound constraint 'F3_1' 14840
  upper bound constraint 'F3_1' 14840
constraint 'F4_1'
  lower bound constraint 'F4_1' 17672
  upper bound constraint 'F4_1' 17672
constraint 'F1_2'
  lower bound constraint 'F1_2' 17393
  upper bound constraint 'F1_2' 17393
constraint 'F2_2'
  lower bound constraint 'F2_2' 19559
  upper bound constraint 'F2_2' 19559
constraint 'F3_2'
  lower bound constraint 'F3_2' 22098
  upper bound constraint 'F3_2' 22098
constraint 'F4_2'
  lower bound constraint 'F4_2' 26833
  upper bound constraint 'F4_2' 26833
$
$ JOB INFO
$
iterate param design 0.01
iterate param objective 0.01
iterate param stoppingtype or
iterate 5
STOP

```

### 22.5.4. Results

The results for both methods are compared below. Note that the optimum Young's modulus differs slightly due to its relative insignificance in the optimization as depicted in the following ANOVA plot representing the 4<sup>th</sup> point of the history plot and demonstrated by the size of its confidence interval (see table).



### 22.5.5. Mean Squared Error (MSE) formulation

Printout of the lsopt\_report file:

```

=====
      M E A N   S Q U A R E D   E R R O R   V A L U E S
=====
                    ITERATION 5
=====

-----
Objective name          MSE
-----
MSE1                    .000221574
MSE2                    .000175544
-----
Total                   .000397118
-----

=====
      M E A N   S Q U A R E D   E R R O R   R E S I D U A L S
=====
                    ITERATION 5
=====

COMPOSITE : MSE1

"Force_vs_Displ" calibrated to "Test1"
-----

Computed MSE Value = 0.00026367
Predicted MSE Value = 0.000221574

-----
      TEST DATA          |          COMPUTED RESULTS          |
-----|-----|-----|-----|-----|-----|-----|
Point  Point  Target  | Computed  Computed  Predicted  Predicted  | Weight  Scale
No.   Location Value  | Value     Error    Value     Error    | Value   Value
-----|-----|-----|-----|-----|-----|-----|

```

1	0.3617	1.016e+04	1.027e+04	107.9	1.026e+04	98.01	1	1.767e+04
2	0.483	1.11e+04	1.08e+04	-298.9	1.08e+04	-299.4	1	1.767e+04
3	0.6044	1.203e+04	1.143e+04	-605.1	1.157e+04	-458	1	1.767e+04
4	0.7257	1.296e+04	1.283e+04	-129.6	1.276e+04	-204.2	1	1.767e+04
5	0.8471	1.359e+04	1.317e+04	-422.7	1.314e+04	-447	1	1.767e+04
6	0.9684	1.421e+04	1.397e+04	-240	1.397e+04	-242.4	1	1.767e+04
7	1.09	1.484e+04	1.49e+04	58.49	1.49e+04	58.67	1	1.767e+04
8	1.211	1.578e+04	1.592e+04	136.1	1.591e+04	131	1	1.767e+04
9	1.332	1.673e+04	1.688e+04	148.9	1.674e+04	16.58	1	1.767e+04
10	1.454	1.767e+04	1.743e+04	-243.2	1.742e+04	-248.4	1	1.767e+04

COMPOSITE : MSE2

"Force\_vs\_Displ2" calibrated to "Test2"

Computed MSE Value = 9.06349e-05  
 Predicted MSE Value = 0.000175544

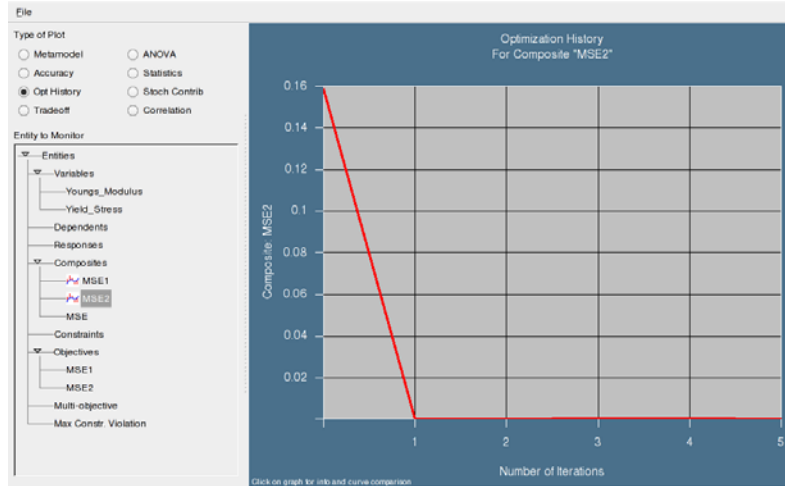
TEST DATA			COMPUTED RESULTS					
Point No.	Point Location	Target Value	Computed Value	Computed Error	Predicted Value	Predicted Error	Weight Value	Scale Value
1	0.3617	1.739e+04	1.753e+04	138.8	1.762e+04	223.9	1	2.683e+04
2	0.483	1.812e+04	1.823e+04	112.7	1.824e+04	127.4	1	2.683e+04
3	0.6044	1.884e+04	1.897e+04	130.5	1.896e+04	121.3	1	2.683e+04
4	0.7257	1.956e+04	1.973e+04	170.2	1.972e+04	165.1	1	2.683e+04
5	0.8471	2.04e+04	2.053e+04	120.7	2.052e+04	118.2	1	2.683e+04
6	0.9684	2.125e+04	2.137e+04	123.3	2.137e+04	119.3	1	2.683e+04
7	1.09	2.209e+04	2.228e+04	184	2.228e+04	184.3	1	2.683e+04
8	1.211	2.367e+04	2.438e+04	705.9	2.471e+04	1037	1	2.683e+04
9	1.332	2.525e+04	2.519e+04	-59.33	2.539e+04	132.9	1	2.683e+04
10	1.454	2.683e+04	2.674e+04	-95.55	2.684e+04	5.068	1	2.683e+04

C O N F I D E N C E I N T E R V A L S

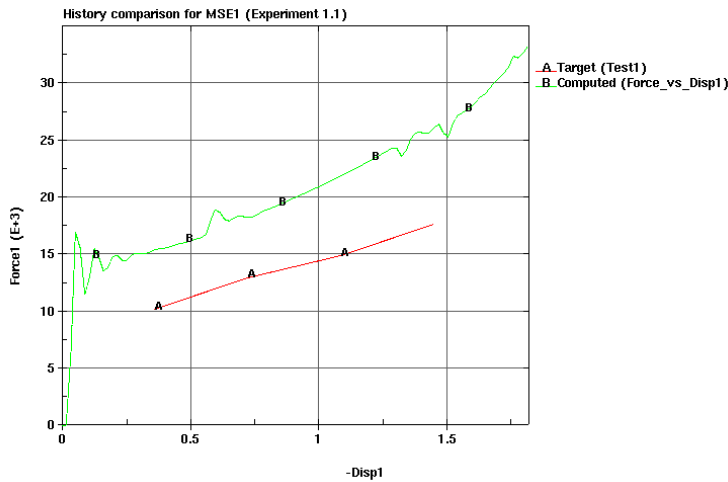
ITERATION 5

90% Confidence intervals for individual optimal parameters

Name	Value	Confidence Interval	
		Lower	Upper
Youngs_Modulus	739559.415	72970.5803	1406148.25
Yield_Stress	1009.14575	978.501323	1039.79017



**Figure 22-28: Optimization history of MSE2. The history plots comparing the response to the test data are selected by clicking near the selected iteration on the plot and then on the MeanSqErrr button.**



**Figure 22-29: Comparison of force-displacement and data from Test1 (baseline)**

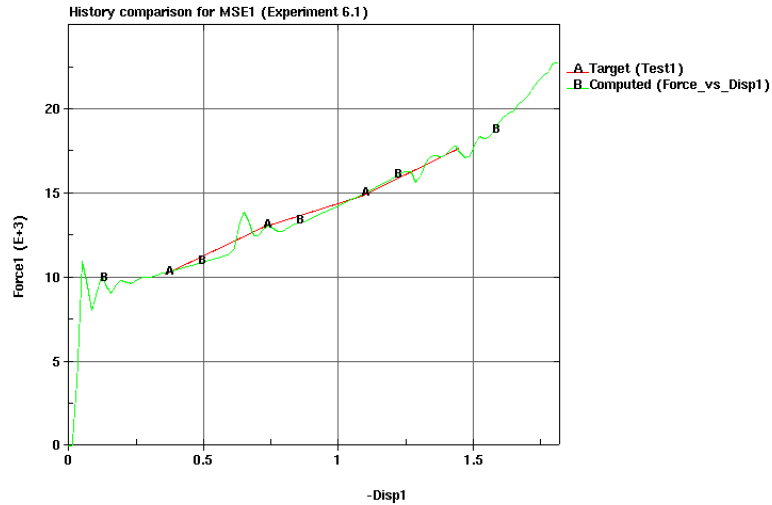


Figure 22-30: Comparison of force-displacement and data from Test1 (optimum)

### 22.5.6. Maximum residual formulation

DESIGN POINT

Variable Name	Lower Bound	Value	Upper Bound
Youngs_Modulus	5e+05	7.083e+05	2e+06
Yield_Stress	500	1001	2000

RESPONSE FUNCTIONS:

RESPONSE	Scaled		Unscaled	
	Computed	Predicted	Computed	Predicted
F1_1	1.02e+04	1.02e+04	1.02e+04	1.02e+04
F2_1	1.273e+04	1.295e+04	1.273e+04	1.295e+04
F3_1	1.478e+04	1.477e+04	1.478e+04	1.477e+04
F4_1	1.735e+04	1.748e+04	1.735e+04	1.748e+04
F1_2	1.743e+04	1.748e+04	1.743e+04	1.748e+04
F2_2	1.957e+04	1.956e+04	1.957e+04	1.956e+04
F3_2	2.21e+04	2.234e+04	2.21e+04	2.234e+04
F4_2	2.653e+04	2.678e+04	2.653e+04	2.678e+04

COMPOSITE FUNCTIONS:

COMPOSITE NAME	Computed	Predicted
Residual	505.2	332.9

CONSTRAINT FUNCTIONS:

CONSTRAINT NAME	Computed	Predicted	Lower	Upper	Viol?
F1_1	1.02e+04	1.02e+04	1.016e+04	1.016e+04	YES
F2_1	1.273e+04	1.295e+04	1.296e+04	1.296e+04	YES
F3_1	1.478e+04	1.477e+04	1.484e+04	1.484e+04	YES
F4_1	1.735e+04	1.748e+04	1.767e+04	1.767e+04	YES
F1_2	1.743e+04	1.748e+04	1.739e+04	1.739e+04	YES
F2_2	1.957e+04	1.956e+04	1.956e+04	1.956e+04	

F3_2	2.21e+04	2.234e+04	2.21e+04	2.21e+04	YES
F4_2	2.653e+04	2.678e+04	2.683e+04	2.683e+04	YES

CONSTRAINT VIOLATIONS:

CONSTRAINT NAME	Computed Violation		Predicted Violation	
	Lower	Upper	Lower	Upper
F1_1	-	37.3	-	35.91
F2_1	230.2	-	10.99	-
F3_1	61.33	-	65.56	-
F4_1	326.2	-	194.5	-
F1_2	-	40.46	-	85.06
F2_2	-	10.74	0.9383	-
F3_2	-	2.992	-	240.1
F4_2	298.1	-	49.21	-

MAXIMUM VIOLATION:

Quantity	Computed		Predicted	
	Constraint	Value	Constraint	Value
Maximum Violation	F4_1	326.2	F3_2	240.1
Smallest Margin	F3_2	2.992	F2_2	0.9383

## 22.6. Large vehicle crash and vibration (MDO/MOO) (7 variables)

(Example by courtesy of DaimlerChrysler)

This example has the following features:

LS-DYNA is used for both explicit full frontal crash and implicit NVH simulations.

Multidisciplinary design optimization (MDO) and Multi-objective optimization (MOO) are illustrated with a realistic full vehicle example.

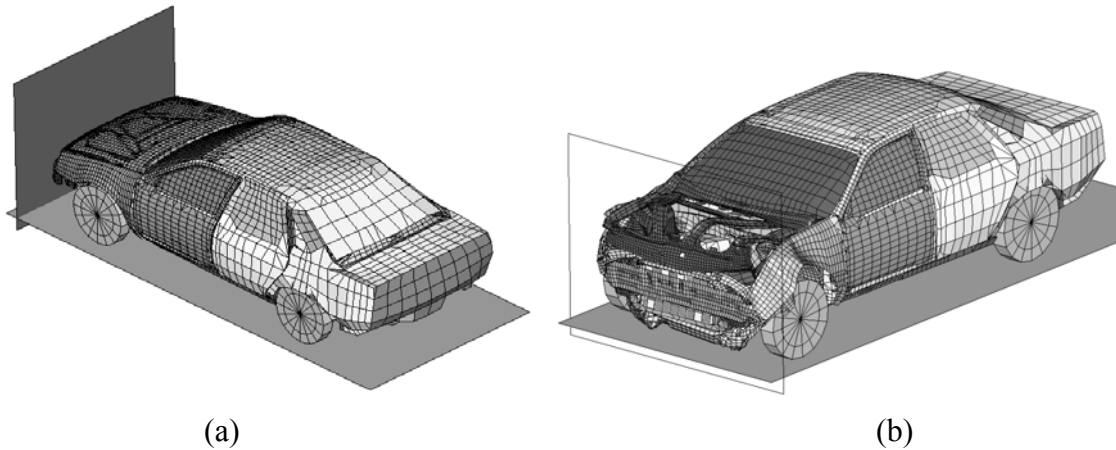
Extraction is performed using standard LS-DYNA interfaces.

This example illustrates a realistic application of Multidisciplinary Design Optimization (MDO) and concerns the coupling of the crash performance of a large vehicle with one of its Noise Vibration and Harshness (NVH) criteria, namely the torsional mode frequency [2].

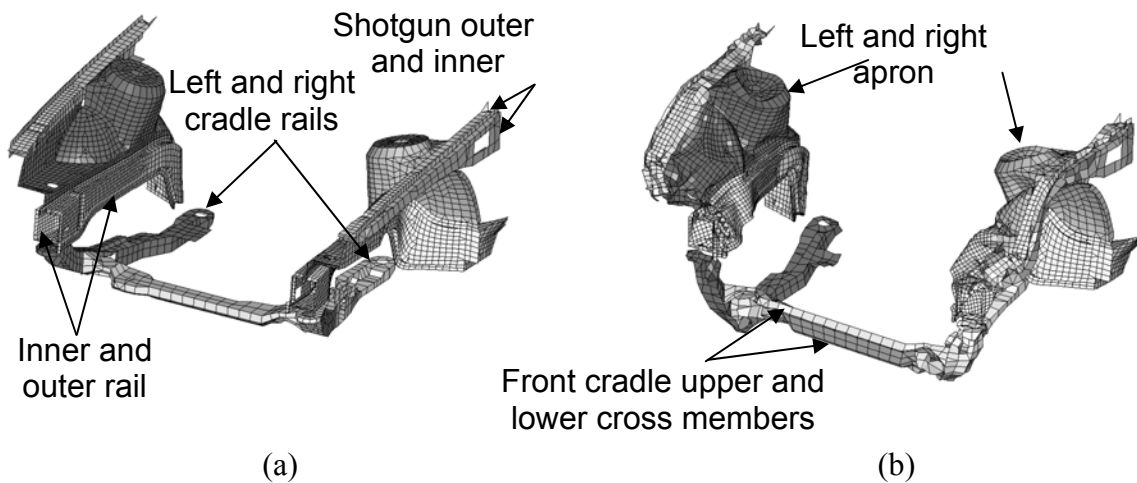
### 22.6.1. FE Modeling

The crashworthiness simulation considers a model containing approximately 30,000 elements of a National Highway Transportation and Safety Association (NHTSA) vehicle [3] undergoing a full frontal impact. A modal analysis is performed on a so-called ‘body-in-white’ model containing approximately 18,000 elements. The crash model for the full vehicle is shown in Figure 22-31 for the undeformed and deformed (time = 78ms) states, and with only the structural components affected by the design variables, both in the undeformed and deformed (time = 72ms) states, in Figure 22-32. The NVH model is depicted in Figure

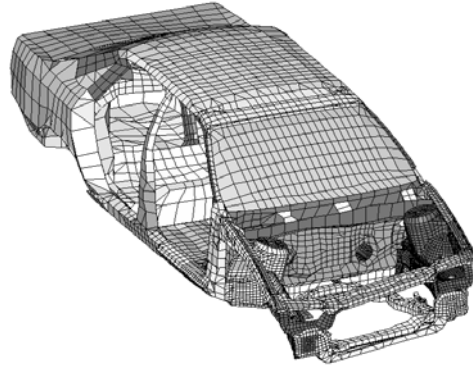
22-33 in the first torsion vibrational mode. Only body parts that are crucial to the vibrational mode shapes are retained in this model. The design variables are all thicknesses or gages of structural components in the engine compartment of the vehicle (Figure 22-32), parameterized directly in the LS-DYNA input file. Twelve parts are affected, comprising aprons, rails, shotguns, cradle rails and the cradle cross member (Figure 22-32). LS-DYNA v.971 is used for both the crash and NVH simulations, in explicit and implicit modes respectively.



**Figure 22-31: Crash model of vehicle showing road and wall a) Undeformed b) Deformed (78ms)**



**Figure 22-32: Structural components affected by design variables – a) Undeformed and (b) deformed (time = 72ms)**



*Figure 22-33: Body-in-white model of vehicle in torsional vibration mode (38.7Hz)*

### 22.6.2. Design formulation

This example illustrates the following:

- Multidisciplinary optimization
- Discrete optimization
- Multi-objective optimization
- Complex mathematical expressions

The formulation is as follows:

$$\begin{aligned}
 & \text{Minimize} && \text{Mass} \\
 & \text{Minimize} && \text{Maximum intrusion} \\
 & \text{subject to} && \\
 & && \text{Maximum intrusion}(\mathbf{x}_{\text{crash}}) < 551.27\text{mm} \\
 & && \text{Stage 1 pulse}(\mathbf{x}_{\text{crash}}) > 14.51\text{g} \\
 & && \text{Stage 2 pulse}(\mathbf{x}_{\text{crash}}) > 17.59\text{g} \\
 & && \text{Stage 3 pulse}(\mathbf{x}_{\text{crash}}) > 20.75\text{g} \\
 & && 41.38\text{Hz} < \text{Torsional mode frequency}(\mathbf{x}_{\text{NVH}}) < 42.38\text{Hz}
 \end{aligned}$$

Variables:

$$\mathbf{x}_{\text{crash}} = [\text{rail\_inner}, \text{rail\_outer}, \text{cradle\_rails}, \text{aprons}, \text{shotgun\_inner}, \text{shotgun\_outer}, \text{cradle\_crossmember}]^T$$

$$\mathbf{x}_{\text{NVH}} = [\text{rail\_inner}, \text{rail\_outer}, \text{cradle\_rails}, \text{aprons}, \text{shotgun\_inner}, \text{shotgun\_outer}, \text{cradle\_crossmember}]^T.$$

The three stage pulses are calculated from the SAE filtered (60Hz) acceleration and displacement of a left rear sill node in the following fashion:



$$\text{Stage } i \text{ pulse} = \frac{-k}{d_2 - d_1} \int_{d_1}^{d_2} a dx ;$$

$k = 0.5$  for  $i = 1$ , 1.0 otherwise;

with the limits  $[d_1; d_2] = [0; 184]$ ;  $[184; 334]$ ;  $[334; \text{Max}(\text{displacement})]$  for  $i = 1, 2, 3$  respectively, all displacement units in mm and the minus sign to convert acceleration to deceleration. The Stage 1 pulse is represented by a triangle with the peak value being the value used.

The constraints are scaled using the target values to balance the violations of the different constraints. This scaling is only important in cases where multiple constraints are violated as in the current problem. However, it is a good idea to apply scaling of constraints as a rule.

### 22.6.3. Input preparation

The MDO and MOO features are specified as follows:

- **MDO.** The two disciplines (crash and NVH) are treated separately. Variables are flagged as local with the `Local variable_name` statement, and then linked to a solver using the `Solver variable variable_name` command.
- **MOO.** Two design objectives (Intrusion and mass) are stated. The weight of the mass has been set to 1.0 whereas the weight on the intrusion has been set to 0.0. These weights are specified in the “Objectives” panel of the GUI. This implies that the optimization path is based on minimal mass alone while the Pareto optimal front is constructed based on both objectives. The GA must be selected (also in the Objectives panel) as metamodel optimizer to obtain the Pareto optimal front.
- **Discrete variables.** These are specified as an array of space delimited values.

The command file is given below:

```

$$$$$$$$$$$$$$$$$$$$$$$$$$$$$$$$$$$$$$$$$$$$$$$$$$$$$$$$$$$$
Command file "com"
$$$$$$$$$$$$$$$$$$$$$$$$$$$$$$$$$$$$$$$$$$$$$$$$$$$$$$$$$$$$
$ Generated using LS-OPT Version 4.1
$
"Taurus Full Vehicle MDO : Crash and NVH. (Manual Ex. 22.6)"
$
Author "Tushar Goel"
$ Created on Wed Jan 6 12:16:56 2010
solvers 2
responses 14
histories 2
$
$ DESIGN VARIABLES
$
variables 7
Variable 'cradle_rails' 1.93
  Lower bound variable 'cradle_rails' 1.
  Upper bound variable 'cradle_rails' 3.
Variable 'cradle_csmb' 1.93
  Lower bound variable 'cradle_csmb' 1.
  Upper bound variable 'cradle_csmb' 3.
Variable 'shotgun_inner' 1.3
  Lower bound variable 'shotgun_inner' 1.
  Upper bound variable 'shotgun_inner' 2.5

```



```

$ NO POSTPROCESSOR SPECIFIED
$ ----- Metamodeling -----
solver order RBF
solver experiment design space_filling
  solver update doe
  solver alternate experiment 1
$ ----- Job information -----
solver concurrent jobs 0
solver queue pbs
$
$$ RESPONSES FOR SOLVER "NVH"
$
response 'Vehicle_Mass_NVH' 2204.62 0 "DynaMass 29 30 32 33 34 35 79 81 82 83 MASS"
response 'Frequency' 1 0 "DynaFreq 2 FREQ"
response 'Mode' 1 0 "DynaFreq 2 NUMBER"
response 'Generalized_Mass' 1 0 "DynaFreq 2 GENMASS"

composites 6
$
$$ COMPOSITE RESPONSES
$
composite 'Disp_scaled' type targeted
  composite 'Disp_scaled' response 'Disp' 0 scale 551.27
composite 'Frequency_scaled' type targeted
  composite 'Frequency_scaled' response 'Frequency' 0 scale 41.8831
$
$ COMPOSITE EXPRESSIONS
$
composite 'Mass_scaled' {Vehicle_Mass_NVH/99.078}
composite 'Stage1Pulse_scaled' {Stage1Pulse/14.512408}
composite 'Stage2Pulse_scaled' {Stage2Pulse/17.586303}
composite 'Stage3Pulse_scaled' {Stage3Pulse/20.745213}
$
$ OBJECTIVE FUNCTIONS
$
objectives 2
objective 'Disp_scaled' 0
objective 'Mass_scaled' 1
$
$ CONSTRAINT DEFINITIONS
$
constraints 5
constraint 'Disp_scaled'
  upper bound constraint 'Disp_scaled' 1
constraint 'Frequency_scaled'
  lower bound constraint 'Frequency_scaled' 0.9881
  upper bound constraint 'Frequency_scaled' 1.0119
constraint 'Stage1Pulse_scaled'
  lower bound constraint 'Stage1Pulse_scaled' 1
constraint 'Stage2Pulse_scaled'
  lower bound constraint 'Stage2Pulse_scaled' 1
constraint 'Stage3Pulse_scaled'
  lower bound constraint 'Stage3Pulse_scaled' 1
$
$ PARAMETERS FOR METAMODEL OPTIMIZATION
$
Metamodel Optimization Strategy SEQUENTIAL
$
iterate param design 0.01
iterate param objective 0.01
iterate param stoppingtype and
$
$ OPTIMIZATION ALGORITHM
$
Optimization Algorithm genetic algorithm
GA Parameter MOEA Type NSGA II
GA Parameter Restart Interval 20
GA Parameter Selection Tournament
GA Parameter Real Crossover type SBX
GA Parameter Real Crossover Distribution Index 10
GA Parameter Real Mutation Distribution Index 10
Use GSA
$
$ JOB INFO
$
$run baseline
  iterate 10
STOP

```

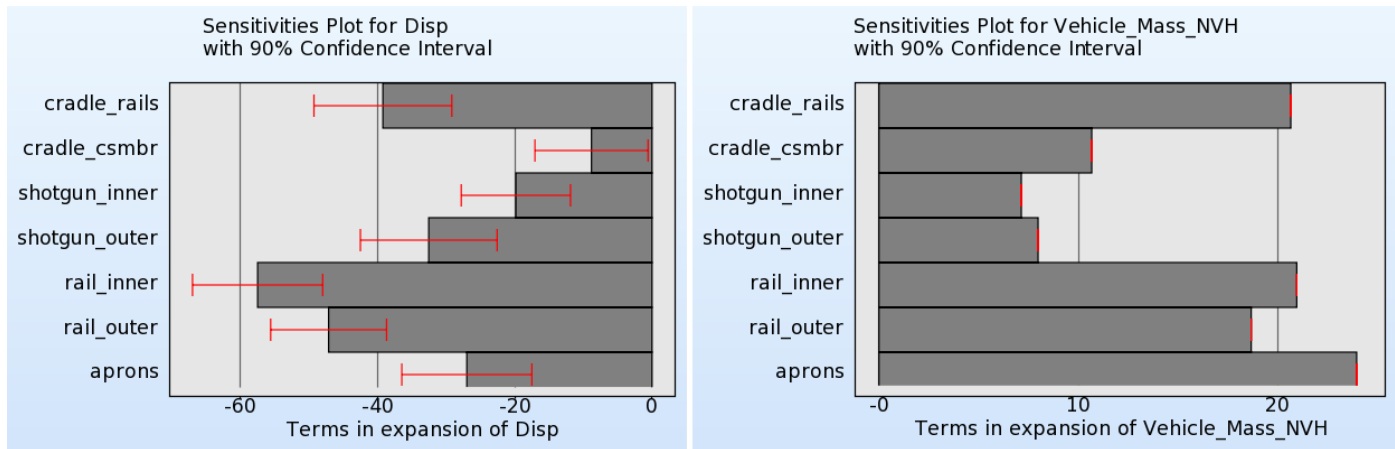
### 22.6.4. Variable screening

The variable screening was done to identify variables with low influence on responses. Both ANOVA and Sobol's global sensitivity methods were used to identify non-influential variables. The plots below showed the ANOVA charts for the 7 design responses (Figure 22-34). The influence of different variables on each case for CRASH and NVH solvers was quantified using Sobol's global sensitivity analysis by considering the optimization problem specific responses (responses that were used as objectives and/or constraints) as shown in Figure 22-35. All plots were based on a single iteration with a linear approximation and  $D$ -optimality criterion as sampling scheme. It was obvious that the rail thicknesses were the most important variables for the CRASH examples; and cradle rail thickness was the most important variable for NVH analysis. The thickness of cradle cross-member was least important for both NVH and CRASH analysis.

From these plots, the most important subsets of variables (global sensitivity index  $> 5\%$ ) were chosen for different cases. More variables were allowed for the NVH analysis because of its relatively small computational cost. The results from the two methods ANOVA and Sobol's GSA were consistent.

$$\mathbf{x}_{\text{crash}} = [\text{rail\_inner}, \text{rail\_outer}, \text{cradle\_rails}, \text{aprons}, \text{shotgun\_outer}]^T;$$

$$\mathbf{x}_{\text{NVH}} = [\text{rail\_inner}, \text{rail\_outer}, \text{cradle\_rails}, \text{aprons}, \text{shotgun\_inner}, \text{shotgun\_outer}]^T.$$



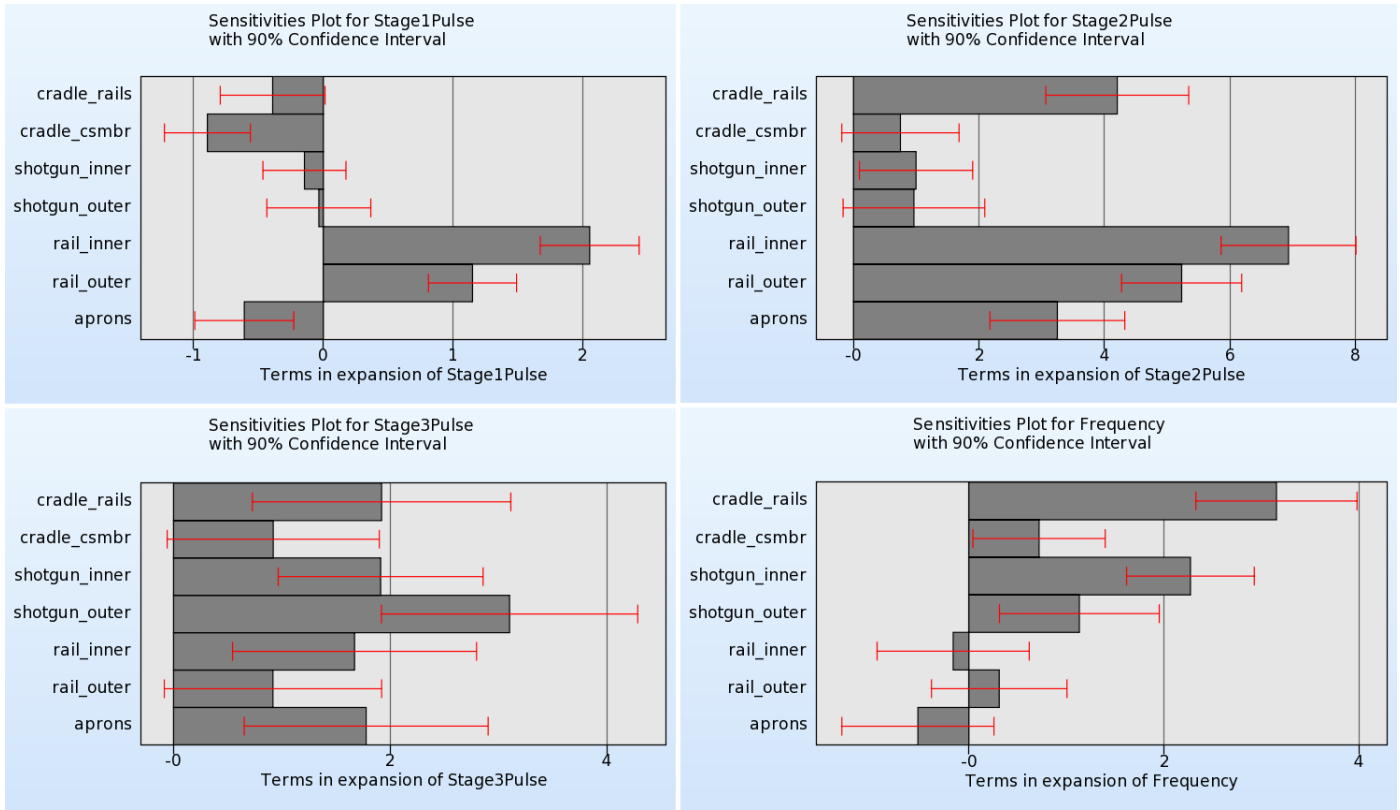


Figure 22-34: ANOVA plots for objectives and constraints.

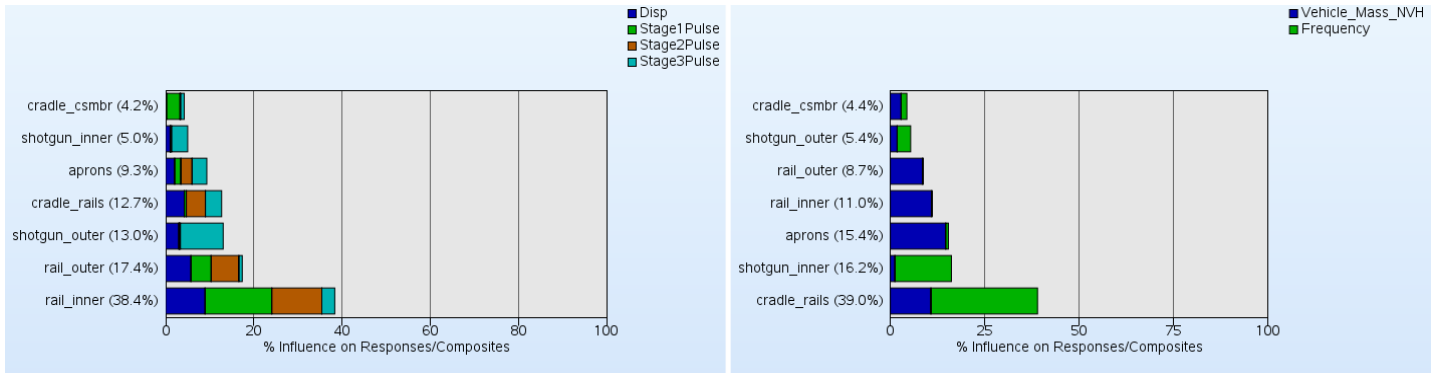
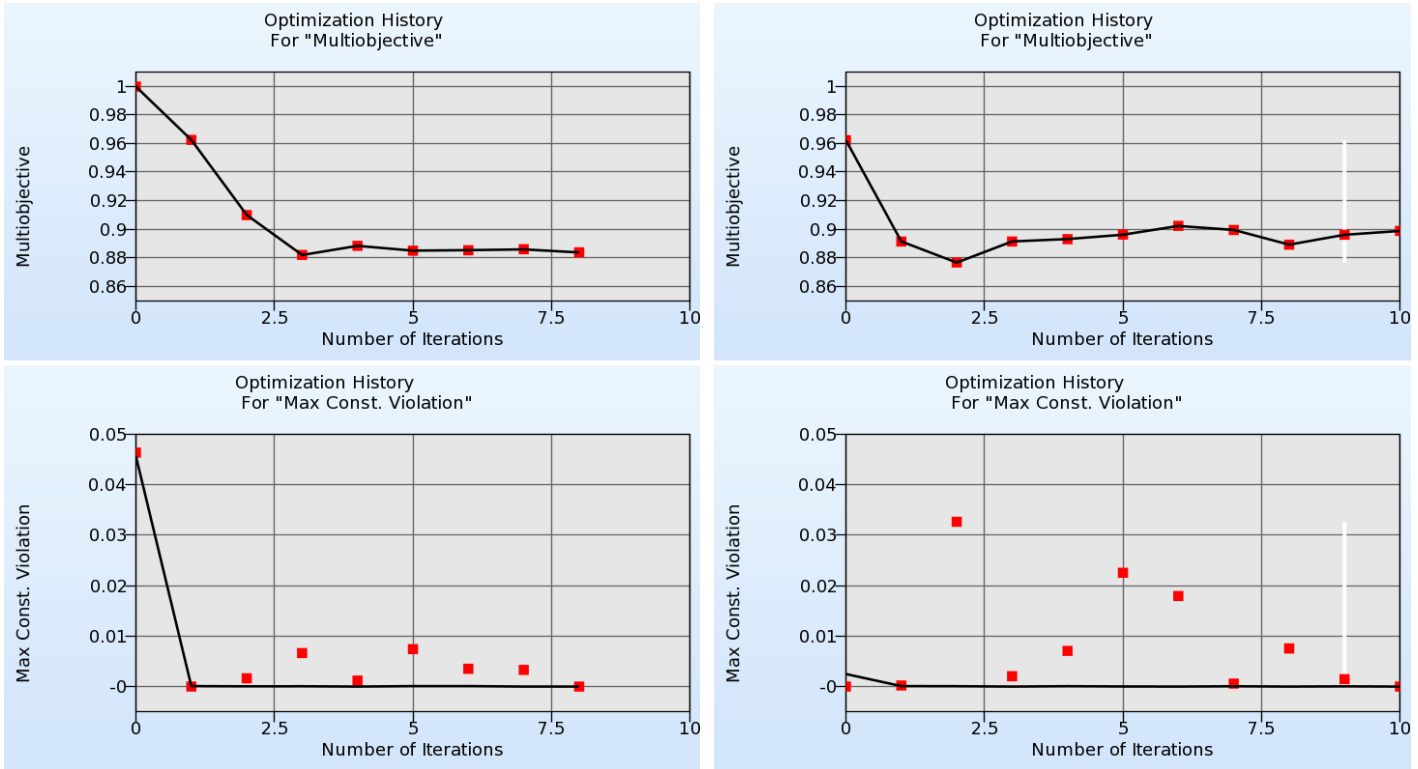


Figure 22-35: Global sensitivity analysis of several responses for different cases.

22.6.5. Optimization history results and Pareto optimal front



Optimization history of mass for full set of variables

Optimization history of mass for screened variables

Figure 22-36: Optimization history of scaled mass.

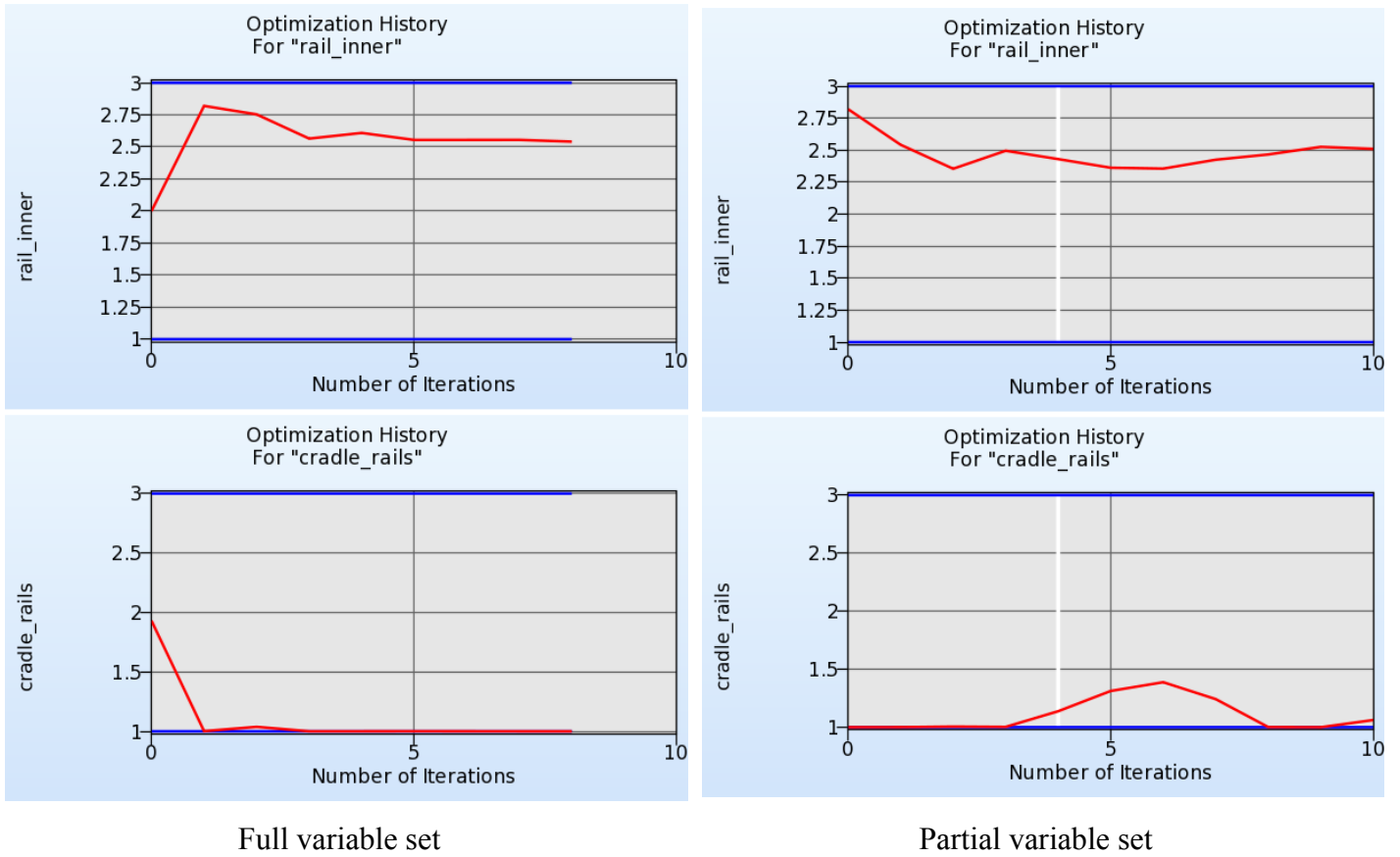


Figure 22-37: Optimization history of the most important variables for CRASH and NVH cases.

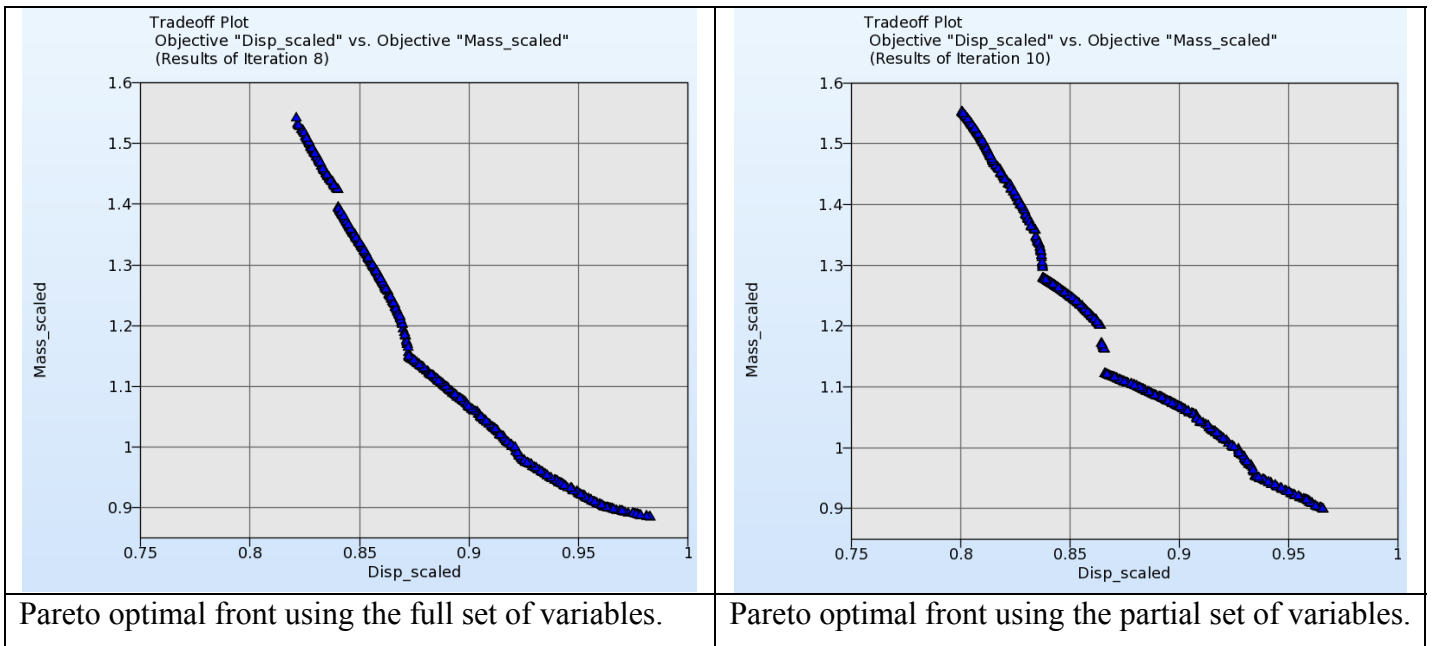


Figure 22-38: Pareto optimal front.

Figure 22-36 shows the optimization history of the mass (objective function). For the purpose of comparison, two optimization runs were conducted, one with the full variable set and the other with the screened variables. Note the similarity of the minimal mass for both cases. The history of the most important variables for different cases is shown in Figure 22-37. The blue lines represent the upper and lower bounds of the region of interest for this variable. Though the histories were different, the final results pointed to similar values of the design variables. The Pareto optimal front obtained for the two cases is shown in Figure 22-38. The reduced variable case was better than the full variable example in the low displacement section whereas the full variable set resulted in better convergence in the low mass section of the Pareto optimal front. This explained the slight anomaly in the final solution shown in the optimization history.

### 22.6.6. Summary of results

The file reported below is the `lsopt_report` file which is viewable using the View→Summary GUI selection in the top menu bar and can also be found in the main working directory. The gradient information (derivatives of the responses with respect to the variables) is also available from the file, but is omitted here for brevity.

```

Evaluated results written to file:
"/florida_1/tushar/MANUAL/TAURUS/REDUCED_VAR/ExtendedResultsMETA_1.csv"

LS-OPT Version      : 4.1
LS-OPT Revision     : 57436
LS-OPT Version Date : Jan 6, 2010

File name           : lsopt_report
This file created on : Thu Jan 7 09:43:34 2010

Project Command File : com

*****
Problem description:
Taurus Full Vehicle MDO : Crash and NVH. (Manual Ex. 22.6)
*****

-----
                N U M B E R S   O F   E A C H   E N T I T Y
-----
Number of design variables ..... 6
Number of response functions ..... 14
Number of constraint functions ..... 5
Number of objective functions ..... 2
-----

                D E S I G N   V A R I A B L E   D A T A
-----

Continuous Variables
-----|-----|-----|
Variable Name   Lower Bound   Upper Bound
-----|-----|-----|
cradle_rails   1               3
shotgun_inner  1               2.5
shotgun_outer  1               2.5
rail_inner     1               3
rail_outer    1               3
aprons        1               2.5
-----

-----
                O B J E C T I V E   F U N C T I O N S
-----
Objective ..... MINIMIZE

-----
Objective name           Weights
-----

```



Disp\_scaled                    0  
 Mass\_scaled                   1

-----  
 -----  
 O P T I M I Z A T I O N   A L G O R I T H M  
 -----

Method ..... Metamodel-based Optimization  
 Strategy ..... Sequential (global sampling)  
 Optimization Algorithm ..... Genetic Algorithm  
 -----

=====

Evaluating Starting Design
ITERATION 1

-----

C O M P U T E D   v s .   P R E D I C T E D  
 -----

Using Metamodel of Iteration 1

DESIGN POINT

Variable Name	Lower Bound	Value	Upper Bound	
cradle_rails	1	1	3	Active
shotgun_inner	1	2.3	2.5	
shotgun_outer	1	2.45	2.5	
rail_inner	1	2.82	3	
rail_outer	1	1.09	3	
aprons	1	1	2.5	Active

RESPONSE VALUES:

Name	Computed	Predicted
Disp	513.4	517.8
time_to_184	0.01475	0.01474
time_to_334	0.02895	0.02892
time_to_max	0.0671	0.0658
Integral_0_184	-1.37e+07	-1.348e+07
Integral_184_334	-2.898e+07	-2.824e+07
Integral_334_max	-4.244e+07	-4.306e+07
Stage1Pulse	15.18	14.93
Stage2Pulse	19.69	19.19
Stage3Pulse	24.11	23.95
Vehicle_Mass_NVH	95.34	95.34
Frequency	42.33	42.49
Mode	2	2.433
Generalized_Mass	1	0.9645

COMPOSITE FUNCTIONS:

COMPOSITE NAME	Computed	Predicted
Disp_scaled	0.9313	0.9392
Frequency_scaled	1.011	1.014
Mass_scaled	0.9623	0.9623
Stage1Pulse_scaled	1.046	1.029
Stage2Pulse_scaled	1.12	1.091
Stage3Pulse_scaled	1.162	1.155

OBJECTIVE:

-----  
 Computed Value =     0.9623  
 Predicted Value =     0.9623

OBJECTIVE VALUES:

Name	Computed	Predicted	WT.
Disp_scaled	0.9313	0.9392	0
Mass_scaled	0.9623	0.9623	1

CONSTRAINT VALUES:

Name	Computed	Predicted	Lower	Upper	Viol?
Disp_scaled	0.9313	0.9392	-1e+30	1	
Frequency_scaled	1.011	1.014	0.9881	1.012	YES
Stage1Pulse_scaled	1.046	1.029	1	1e+30	
Stage2Pulse_scaled	1.12	1.091	1	1e+30	
Stage3Pulse_scaled	1.162	1.155	1	1e+30	

CONSTRAINT VIOLATIONS:

Name	Computed Violation		Predicted Violation	
	Lower	Upper	Lower	Upper
Disp_scaled	-	-	-	-
Frequency_scaled	-	-	-	0.002489
Stage1Pulse_scaled	-	-	-	-
Stage2Pulse_scaled	-	-	-	-
Stage3Pulse_scaled	-	-	-	-

MAXIMUM VIOLATION:

Quantity	Computed		Predicted	
	Constraint	Value	Constraint	Value
Maximum Violation	Disp_scaled	0	Frequency_scaled	0.002489
Smallest Margin	Frequency_scaled	0.001296	Frequency_scaled	0.002489

=====

ERROR MEASURES FOR RESPONSES

ITERATION 10

Number of points = 100

Response Name	Metamodel type	RMS Error	RMS Error (% of mean)	Maximum Residual	Sq. Root PRESS	Sq. Root PRESS (% of mean)	R-Sq.	R-Sq. Predicted
Disp	RBF Net	3.75	0.723	10.6	5.74	1.11	0.979	0.964
time_to_184	RBF Net	6.01e-07	0.00408	2.35e-06	1.63e-06	0.0111	0.997	0.991
time_to_334	RBF Net	1.97e-05	0.0678	6.25e-05	3.69e-05	0.127	0.997	0.994
time_to_max	RBF Net	0.000981	1.49	0.00335	0.00118	1.8	0.914	0.898
Integral_0_184	RBF Net	7.19e+04	0.554	1.96e+05	1.3e+05	0.998	0.985	0.968
Integral_184_334	RBF Net	5.95e+05	2.01	2.01e+06	7.28e+05	2.46	0.982	0.977
Integral_334_max	RBF Net	4.37e+05	1.06	1.32e+06	6.05e+05	1.46	0.991	0.985
Stage1Pulse	RBF Net	0.0797	0.554	0.218	0.144	0.999	0.985	0.968
Stage2Pulse	RBF Net	0.404	2.01	1.36	0.494	2.46	0.982	0.977
Stage3Pulse	RBF Net	0.418	1.82	1.02	0.694	3.02	0.847	0.721
Vehicle_Mass_NVH	RBF Net	0.00711	0.00649	0.0219	0.00759	0.00692	1	1
Frequency	RBF Net	0.00475	0.0113	0.0207	0.0567	0.135	1	0.998
Mode	RBF Net	0.194	8.5	0.503	0.26	11.4	0.792	0.665
Generalized_Mass	RBF Net	0.028	2.92	0.118	0.035	3.66	0.543	0.454

=====

GLOBAL SENSITIVITY ESTIMATES

Cumulative Variable Influence [CRASH]

Variable	AVERAGED		MAXIMUM	
	Main Effect	Total Effect	Main Effect	Total Effect
cradle_rails	0.105	0.12	0.167	0.182
shotgun_inner	-0.00942	0	0.00219	0
shotgun_outer	0.0465	0.0602	0.304	0.339
rail_inner	0.493	0.516	0.692	0.704
rail_outer	0.206	0.228	0.339	0.349
aprons	0.0914	0.107	0.197	0.251

Cumulative Variable Influence [NVH]

Variable	AVERAGED		MAXIMUM	
	Main Effect	Total Effect	Main Effect	Total Effect
cradle_rails	0.295	0.33	0.442	0.495
shotgun_inner	0.298	0.334	0.444	0.473
shotgun_outer	0.146	0.164	0.266	0.296
rail_inner	0.0631	0.0685	0.219	0.231
rail_outer	0.0596	0.0721	0.177	0.189
aprons	0.0809	0.0892	0.287	0.299

=====

F I N A L D E S I G N

ITERATION 11

=====

DESIGN POINT

Variable Name	Lower Bound	Value	Upper Bound
cradle_rails	1	1.062	3
shotgun_inner	1	1.651	2.5
shotgun_outer	1	2.496	2.5
rail_inner	1	2.51	3
rail_outer	1	1	3 Active
aprons	1	1	2.5 Active

RESPONSE VALUES:

Name	Computed	Predicted
Disp	528.3	532.4
time_to_184	0.01474	0.01474
time_to_334	0.02874	0.02874
time_to_max	0.06865	0.06957
Integral_0_184	-1.361e+07	-1.364e+07
Integral_184_334	-2.611e+07	-2.589e+07
Integral_334_max	-4.475e+07	-4.494e+07
Stage1Pulse	15.07	15.12
Stage2Pulse	17.74	17.59
Stage3Pulse	23.48	23.05
Vehicle_Mass_NVH	89.05	89.05
Frequency	41.41	41.4
Mode	2	1.971
Generalized_Mass	0.9964	0.9992

COMPOSITE FUNCTIONS:

COMPOSITE NAME	Computed	Predicted
Disp_scaled	0.9583	0.9658
Frequency_scaled	0.9886	0.9884
Mass_scaled	0.8988	0.8988
Stage1Pulse_scaled	1.039	1.042
Stage2Pulse_scaled	1.009	1
Stage3Pulse_scaled	1.132	1.111

OBJECTIVE:

-----

Computed Value = 0.8988  
 Predicted Value = 0.8988

OBJECTIVE VALUES:

Name	Computed	Predicted	WT.
Disp_scaled	0.9583	0.9658	0
Mass_scaled	0.8988	0.8988	1

CONSTRAINT VALUES:

Name	Computed	Predicted	Lower	Upper	Viol?
Disp_scaled	0.9583	0.9658	-1e+30	1	
Frequency_scaled	0.9886	0.9884	0.9881	1.012	
Stage1Pulse_scaled	1.039	1.042	1	1e+30	
Stage2Pulse_scaled	1.009	1	1	1e+30	
Stage3Pulse_scaled	1.132	1.111	1	1e+30	

CONSTRAINT VIOLATIONS:

Name	Computed Violation		Predicted Violation	
	Lower	Upper	Lower	Upper
Disp_scaled	-	-	-	-
Frequency_scaled	-	-	-	-
Stage1Pulse_scaled	-	-	-	-
Stage2Pulse_scaled	-	-	-	-
Stage3Pulse_scaled	-	-	-	-

MAXIMUM VIOLATION:

Quantity	Computed		Predicted	
	Constraint	Value	Constraint	Value
Maximum Violation	Disp_scaled	0	Disp_scaled	0
Smallest Margin	Frequency_scaled	0.0004954	Frequency_scaled	0.0002608

ANALYSIS COMPLETED

Thu Jan 7 15:58:13 2010

### 22.6.7. Multi-objective optimization using Direct GA simulation

Next, this MDO problem is solved to study the trade-off between mass and intrusion. The problem statement is given as:

Minimize Mass

Minimize Maximum intrusion

subject to

$$\text{Stage 1 pulse}(\mathbf{x}_{\text{crash}}) > 14.51\text{g}$$

$$\text{Stage 2 pulse}(\mathbf{x}_{\text{crash}}) > 17.59\text{g}$$

Stage 3 pulse( $x_{\text{crash}}$ ) > 20.75g

41.38Hz < Torsional mode frequency( $x_{\text{NVH}}$ ) < 42.38Hz (*Fully-shared variables*)

The problem is solved using direct GA simulations. For this problem, all seven design variables were used for both disciplines. The NSGA-II algorithm (*MOEA*) was used in conjunction with real encoding of design variables. Tournament selection operator (*Selection*), with a tournament size of two (*Tourn Size*), was used to remove individuals with low fitness values. The simulated binary crossover (*Real Crossover Type*) and mutation operators were used to create child populations. The distribution index for crossover and mutation were taken as 5 (*Crossover Distribution Index, Mutation Distribution Index*). The trade-off files were generated at each generation (*Restart Interval*). The GA parameters are implemented as follows:

```

$$$$$$$$$$$$$$$$$$$$$$$$$$$$$$$$$$$$$$$$
$      OPTIMIZATION METHOD
$$$$$$$$$$$$$$$$$$$$$$$$$$$$$$$$$$$$$$$$
$
Optimization Method GA

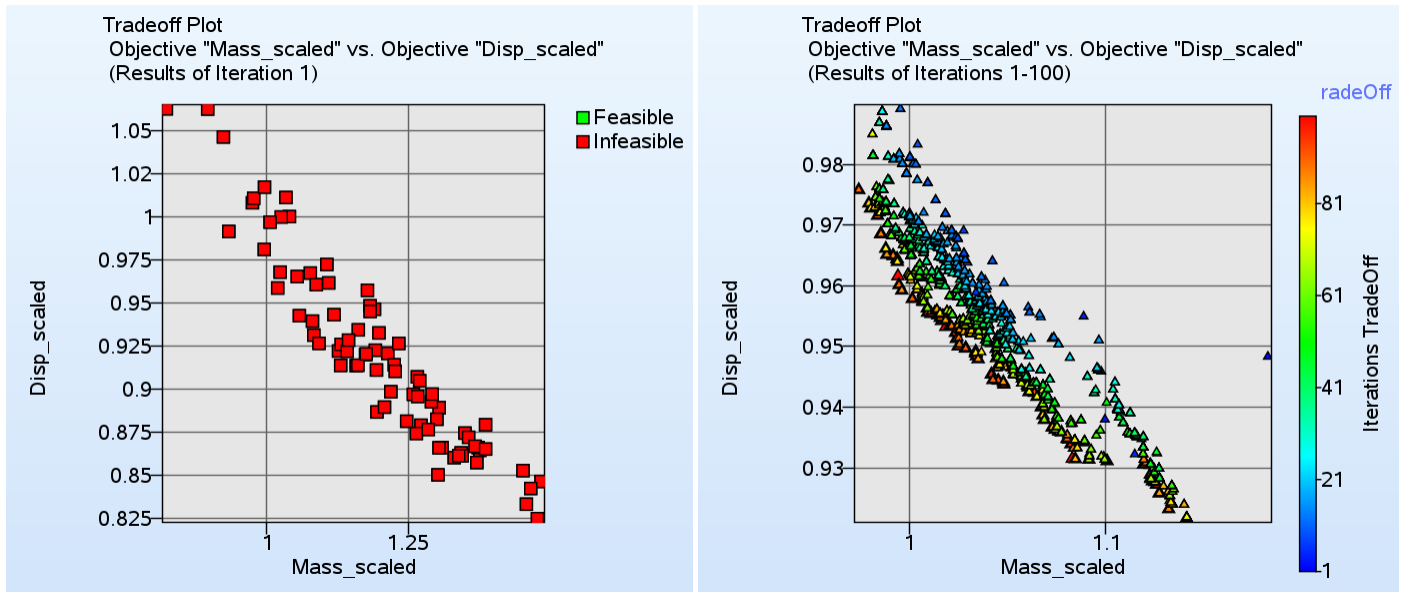
$$$$$$$$$$$$$$$$$$$$$$$$$$$$$$$$$$$$$$$$
$ Genetic Algorithm Parameters
$$$$$$$$$$$$$$$$$$$$$$$$$$$$$$$$$$$$$$$$
GA Parameter Popsize 80
GA Parameter Generation 100
GA Parameter MOEA NSGA II
GA Parameter Selection Tournament
GA Parameter Tourn Size 2
GA Parameter Real Crossover Type SBX
GA Parameter Real Crossover Probability 0.99
GA Parameter Real Crossover Distribution Index 5.0
GA Parameter Real Mutation Probability 0.15
GA Parameter Real Mut Dist Index 5.0
GA Parameter Restart Interval 1

$
$ COMPOSITE RESPONSES
$
composite 'Disp_scaled' type targeted
  composite 'Disp_scaled' response 'Disp' 0 scale 551.27
composite 'Frequency_scaled' type targeted
  composite 'Frequency_scaled' response 'Frequency' 0 scale 41.8831
$
$ COMPOSITE EXPRESSIONS
$
composite 'Stage1Pulse_scaled' {Stage1Pulse/14.512408}
composite 'Stage2Pulse_scaled' {Stage2Pulse/17.586303}
composite 'Stage3Pulse_scaled' {Stage3Pulse/20.745213}
$
$ OBJECTIVE FUNCTIONS
$
objectives 2
objective 'Mass_scaled' 1
objective 'Disp_scaled' 1
$
$ CONSTRAINT DEFINITIONS
$
constraints 4
constraint 'Frequency_scaled'
  lower bound constraint 'Frequency_scaled' 0.9881
  upper bound constraint 'Frequency_scaled' 1.0119
constraint 'Stage1Pulse_scaled'
  lower bound constraint 'Stage1Pulse_scaled' 1
constraint 'Stage2Pulse_scaled'
  lower bound constraint 'Stage2Pulse_scaled' 1
constraint 'Stage3Pulse_scaled'

```

```
lower bound constraint 'Stage3Pulse_scaled' 1
$$$$$$$$$$$$$$$$$$$$$$$$$$$$$$$$$$$$$$$$$$$$
```

The outcome of the optimization is shown in Figure 22-39. Initial population did not have any feasible design but after running for 100 generations, the population resulted into 81 unique non-dominated designs. These designs are shown by blue dots (connected by the line) on the left hand-side.



Initial population – no feasible design

Tradeoff solutions at different generations

**Figure 22-39: Tradeoffs between scaled mass and intrusion (displacement).**

The results show that the potential of improvement by using multi-objective optimization. Trade-off between the two objectives shows that intrusion can be reduced by increasing the mass. The trade-off curve clearly illustrates that reduction in intrusion (from 0.922 to 0.976) might require proportionate increase in mass (from 0.974 to 1.14). A trade-off design (0.974, 0.976) can achieve nearly 2.5% reduction in both objectives. The ranges of the optimal design variables corresponding to the candidate Pareto optimal front are given in Table 22-4. Quite interestingly, the variations in different design variables are fairly small.

**Table 22-4: Ranges of design variables in the final optimal solution set.**

Variable	Lower	Upper
Rail inner	2.99	3.00
Rail outer	1.20	1.35
Aprons	1.15	1.80
Shotgun inner	1.00	1.3
Shotgun outer	1.19	2.11
Cradle cross member	2.27	3.00
Cradle rails	1	1.05

## 22.7. Knee impact with variable screening (11 variables)

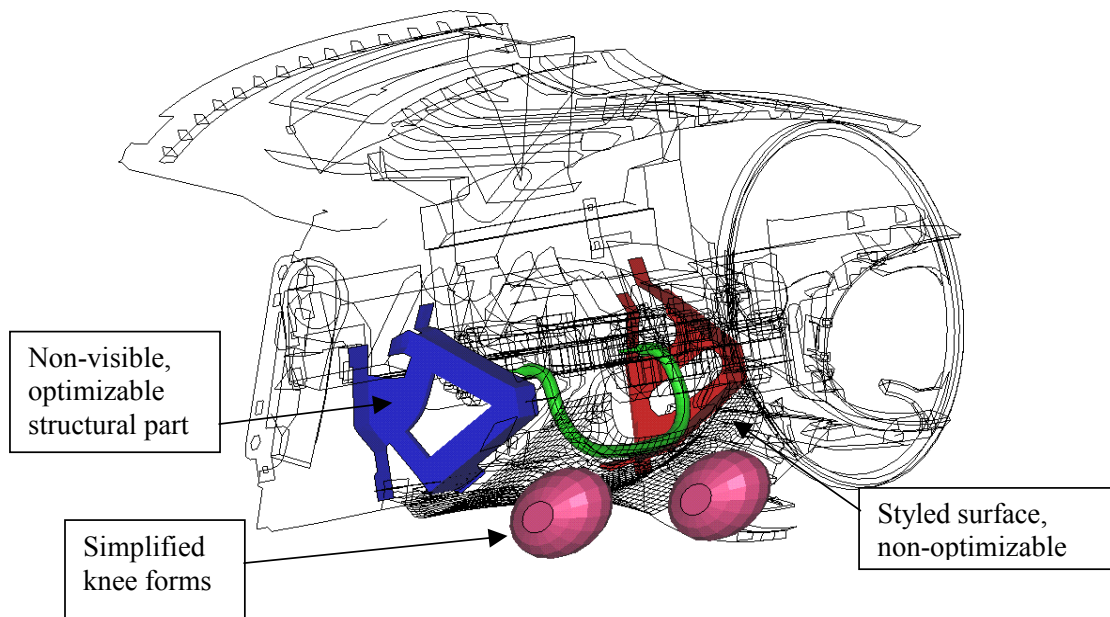
(Example by courtesy of Visteon and Ford Motor Company)

This example has the following new features:

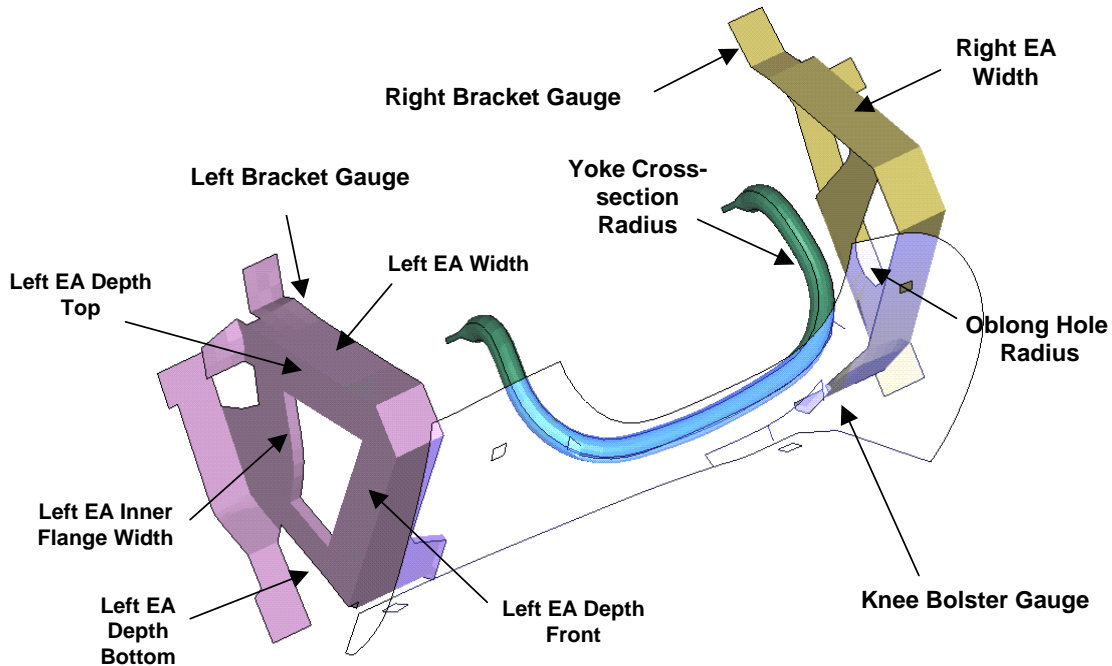
- A sequential optimization is done using a constant region of interest
- An independent parametric preprocessor is used
- The minimum of two maxima is obtained in the objective (multi-criteria or multi-objective problem). The LFOPC metamodel optimization algorithm (the default algorithm) is used for this purpose.
- A pre-processor is used for shape parameterization.

### 22.7.1. FE modeling

Figure 22-40 shows the finite element model of a typical automotive instrument panel (IP) [4]. For model simplification and reduced per-iteration computational times, only the driver's side of the IP is used in the analysis, and consists of around 25,000 shell elements. Symmetry boundary conditions are assumed at the centerline, and to simulate a bench component "Bendix" test, body attachments are assumed fixed in all 6 directions. Also shown in Figure 22-40 are simplified knee forms which move in a direction as determined from prior physical tests. As shown in the figure, this system is composed of a knee bolster (steel, plastic or both) that also serves as a steering column cover with a styled surface, and two energy absorption (EA) brackets (usually steel) attached to the cross vehicle IP structure. The brackets absorb a significant portion of the lower torso energy of the occupant by deforming appropriately. Sometimes, a steering column isolator (also known as a yoke) may be used as part of the knee bolster system to delay the wrap-around of the knees around the steering column. The last three components are non-visible and hence their shape can be optimized. The 11 design variables are shown in Figure 22-41. The three gauges and the yoke cross-sectional radius are also considered in a separate sizing (4 variable) optimization.



*Figure 22-40: Typical instrument panel prepared for a "Bendix" component test*



*Figure 22-41: Typical major components of a knee bolster system and definition of design variables.*

The simulation is carried out for a 40 ms duration by which time the knees have been brought to rest. It may be mentioned here that the Bendix component test is used mainly for knee bolster system development; for certification purposes, a different physical test representative of the full vehicle is performed. Since the simulation used herein is at a subsystem level, the results reported here may be used mainly for illustration purposes.

### 22.7.2. Design formulation

The optimization problem is defined as follows:

Minimize  $(\max(\text{Knee\_Force\_Left}, \text{Knee\_Force\_Right}))$

Subject to

Left Knee intrusion  $< 115\text{mm}$

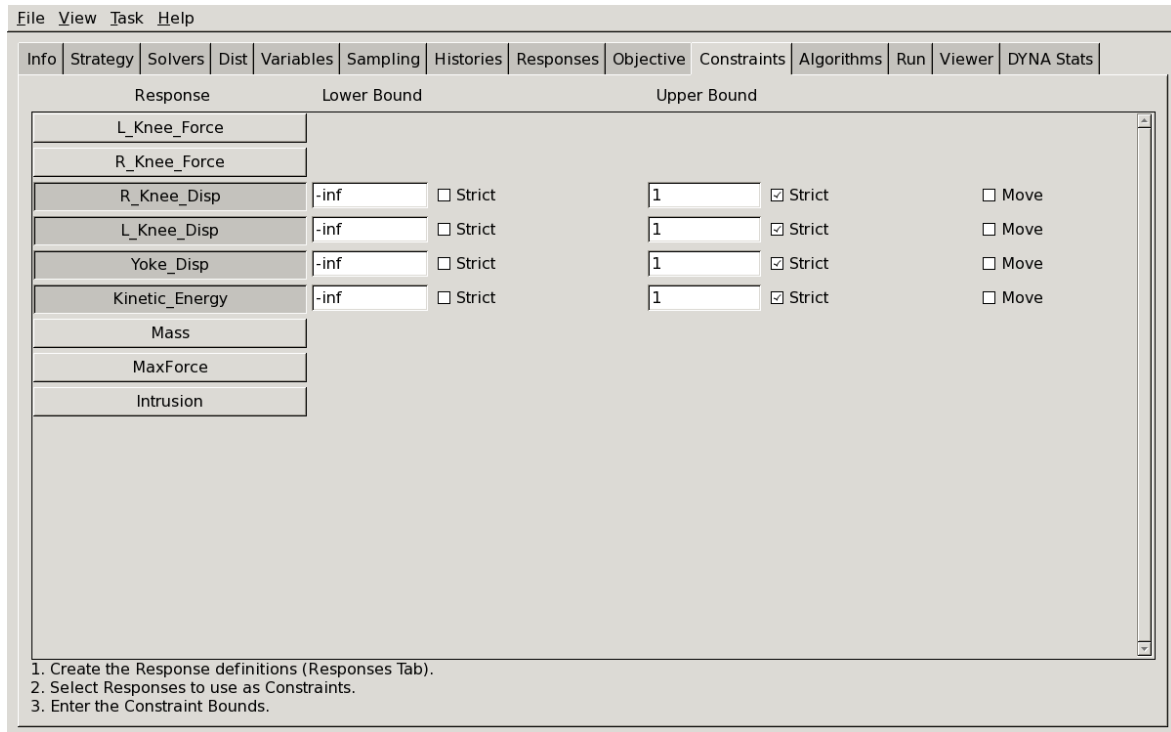
Right Knee intrusion  $< 115\text{mm}$

Yoke displacement  $< 85\text{mm}$

Kinetic Energy  $< 1.54\text{e}5$



Minimization over both knee forces is achieved by constraining them to impossibly low values. The LFOPC optimization algorithm must be selected since it will therefore always try to minimize the maximum knee force. The constraints other than the knee forces need to be set to “strict” so that if violations occur, only the knee forces will be violated. The “Constraints” panel of the GUI is shown below.



**Figure 22-42: Constraints for the knee bolster design problem.**

The knee forces have been filtered, SAE 60 Hz, to improve the approximation accuracy.

### 22.7.3. Input preparation

Truegrid is used to parameterize the geometry. The section of the Truegrid input file (s7.tg) where the design variables are substituted, is shown below:

```
para
w1 <<L_Flange_Width>>      c Left EA flange width
w2 <<R_Flange_Width>>      c Right EA flange width
thick1 <<L_Bracket_Gauge>>  c Left bracket gauge
thick2 <<R_Bracket_Gauge>>  c Right bracket gauge
thick3 <<Bolster_gauge>>    c Knee bolster gauge
f1 <<T_Flange_Depth>>      c Left EA Depth Top
f2 <<F_Flange_Depth>>      c Left EA Depth Front
f3 <<B_Flange_Depth>>      c Left EA Depth Bottom
f4 <<I_Flange_Width>>      c Left EA Inner Flange Width
r1 <<Yoke_Radius>>         c Yoke bar radius
r2 <<R_Bracket_Radius>>    c Oblong hole radius
```

The LS-OPT input file is shown below for the 11-variable shape optimization case:

```

$$$$$$$$$$$$$$$$$$$$$$$$$$$$$$$$$$$$$$$$$$$$$$$$$$$$$$$$$$$$$$$$$$$$$$$$$$$$$$$$$$$$$$$$$$$$
Command file "com_seq"
$$$$$$$$$$$$$$$$$$$$$$$$$$$$$$$$$$$$$$$$$$$$$$$$$$$$$$$$$$$$$$$$$$$$$$$$$$$$$$$$$$$$$$$$$$$$
$ Generated using LS-OPT Version 4.1
$
"Knee impact with 11 variables"
$
$ Created on Fri Jan  8 16:39:08 2010
solvers 1
responses 7
$
$ NO HISTORIES ARE DEFINED
$
$
$ DESIGN VARIABLES
$
variables 11
Variable 'L_Bracket_Gauge' 1.1
  Lower bound variable 'L_Bracket_Gauge' .7
  Upper bound variable 'L_Bracket_Gauge' 3.
Variable 'T_Flange_Depth' 28.3
  Lower bound variable 'T_Flange_Depth' 20.
  Upper bound variable 'T_Flange_Depth' 50.
Variable 'F_Flange_Depth' 27.5
  Lower bound variable 'F_Flange_Depth' 20.
  Upper bound variable 'F_Flange_Depth' 50.
Variable 'B_Flange_Depth' 22.3
  Lower bound variable 'B_Flange_Depth' 15.
  Upper bound variable 'B_Flange_Depth' 50.
Variable 'I_Flange_Width' 7.
  Lower bound variable 'I_Flange_Width' 5.
  Upper bound variable 'I_Flange_Width' 25.
Variable 'L_Flange_Width' 32.
  Lower bound variable 'L_Flange_Width' 20.
  Upper bound variable 'L_Flange_Width' 50.
Variable 'R_Bracket_Gauge' 1.1
  Lower bound variable 'R_Bracket_Gauge' .7
  Upper bound variable 'R_Bracket_Gauge' 3.
Variable 'R_Flange_Width' 32.
  Lower bound variable 'R_Flange_Width' 20.
  Upper bound variable 'R_Flange_Width' 50.
Variable 'R_Bracket_Radius' 15.
  Lower bound variable 'R_Bracket_Radius' 10.
  Upper bound variable 'R_Bracket_Radius' 25.
Variable 'Bolster_gauge' 3.5
  Lower bound variable 'Bolster_gauge' 1.
  Upper bound variable 'Bolster_gauge' 6.
Variable 'Yolk_Radius' 4.
  Lower bound variable 'Yolk_Radius' 2.
  Upper bound variable 'Yolk_Radius' 8.

$$$$$$$$$$$$$$$$$$$$$$$$$$$$$$$$$$$$$$$$$$$$$$$$$$$$$$$$$$$$$$$$$$$$$$$$$$$$$$$$$$$$$$$$$$$$
$ OPTIMIZATION METHOD
$$$$$$$$$$$$$$$$$$$$$$$$$$$$$$$$$$$$$$$$$$$$$$$$$$$$$$$$$$$$$$$$$$$$$$$$$$$$$$$$$$$$$$$$$$$$
$
Optimization Method SRSM

$$$$$$$$$$$$$$$$$$$$$$$$$$$$$$$$$$$$$$$$$$$$$$$$$$$$$$$$$$$$$$$$$$$$$$$$$$$$$$$$$$$$$$$$$$$$
$ SOLVER "1"
$$$$$$$$$$$$$$$$$$$$$$$$$$$$$$$$$$$$$$$$$$$$$$$$$$$$$$$$$$$$$$$$$$$$$$$$$$$$$$$$$$$$$$$$$$$$
$
$ DEFINITION OF SOLVER "1"
$
$ solver dyna960 '1'
$ solver command "/florida_1/tushar/MANUAL/KNEE/ALLVAR/submit_pbs"
$ solver input file "ford7.k"
$ solver check output off
$ solver compress d3plot off
$ ----- Pre-processor -----
$ prepro truegrid
$ prepro command "sleep 90;cp ../../curves .; cp ../../node .; cp ../../elem .; cp ../../elem-bar .; pwd;tg"
$ prepro input file "s7.tg"
$ ----- Post-processor -----
$ NO POSTPROCESSOR SPECIFIED
$ ----- Metamodeling -----
$ solver order RBF

```

```

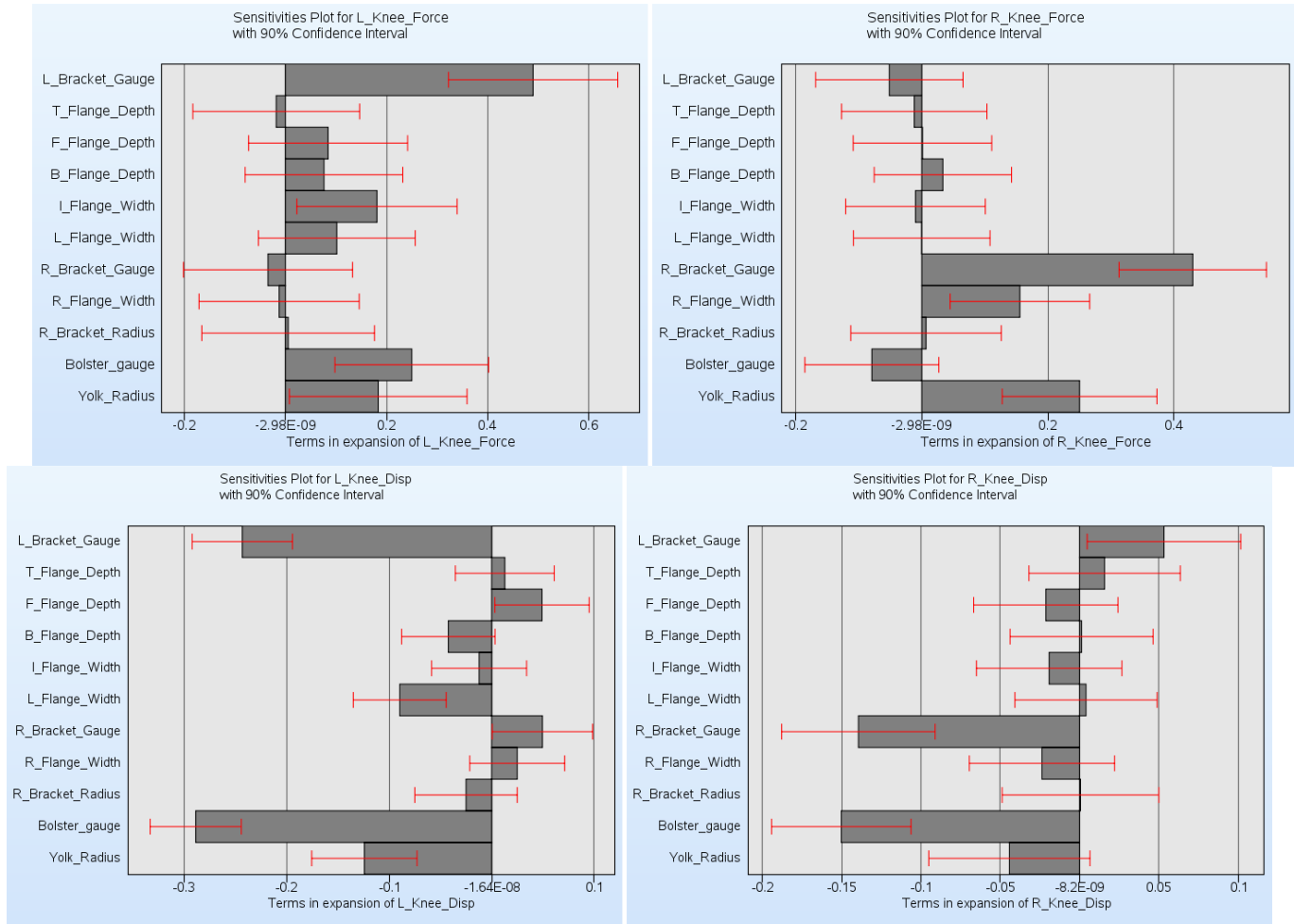
solver RBF transfer Gauss
solver RBF optimize GCV
solver experiment design space_filling
solver number experiments 21
solver update doe
solver alternate experiment 1
$ ----- Job information -----
solver concurrent jobs 0
solver queue pbs
$
$$ RESPONSES FOR SOLVER "1"
$
response 'L_Knee_Force' 0.000153846 0 "BinoutResponse -res_type RCForc -cmp force -invariant MAGNITUDE -id
1 -side MASTER -select MAX -start_time 0.0000 -filter SAE -filter_freq 60.0000"
response 'R_Knee_Force' 0.000153846 0 "BinoutResponse -res_type RCForc -cmp force -invariant MAGNITUDE -id
2 -side MASTER -select MAX -start_time 0.0000 -filter SAE -filter_freq 60.0000"
response 'L_Knee_Disp' 0.00869565 0 "BinoutResponse -res_type Nodout -cmp displacement -invariant
MAGNITUDE -id 24897 -select MAX -start_time 0.0000"
response 'R_Knee_Disp' 0.00869565 0 "BinoutResponse -res_type Nodout -cmp displacement -invariant
MAGNITUDE -id 25337 -select MAX -start_time 0.0000"
response 'Yoke_Disp' 0.0117647 0 "BinoutResponse -res_type Nodout -cmp displacement -invariant MAGNITUDE -
id 28816 -select MAX -start_time 0.0000"
response 'Kinetic_Energy' 6.49351e-06 0 "BinoutResponse -res_type GLStat -cmp kinetic_energy -select TIME
"
response 'Mass' 638.162 0 "DynaMass 7 8 48 62 MASS"

composites 2
$
$$ COMPOSITE EXPRESSIONS
$
composite 'MaxForce' {max(L_Knee_Force,R_Knee_Force)}
composite 'Intrusion' {(L_Knee_Disp+R_Knee_Disp)/2}
$
$ OBJECTIVE FUNCTIONS
$
objectives 1
objective 'MaxForce' 1
$
$ CONSTRAINT DEFINITIONS
$
constraints 4
constraint 'L_Knee_Disp'
strict
upper bound constraint 'L_Knee_Disp' 1
constraint 'R_Knee_Disp'
slack
strict
upper bound constraint 'R_Knee_Disp' 1
constraint 'Yoke_Disp'
slack
strict
upper bound constraint 'Yoke_Disp' 1
constraint 'Kinetic_Energy'
slack
strict
upper bound constraint 'Kinetic_Energy' 1
$
$ PARAMETERS FOR METAMODEL OPTIMIZATION
$
Metamodel Optimization Strategy SEQUENTIAL
$
iterate param design 0.01
iterate param objective 0.01
iterate param stoppingtype and
$
$ OPTIMIZATION ALGORITHM
$
Optimization Algorithm hybrid simulated annealing
$
$ SA PARAMETERS
$
sa maximum simulation 20000
Use GSA
Set GSA Resolution 100000
$
$ JOB INFO
$
$ run baseline
iterate 10
STOP

```

### 22.7.4. Variable screening

A single iteration is done with a linear approximation to generate the ANOVA and Sobol's global sensitivity analysis charts. The charts are shown in the figure below. Note the large confidence intervals (low confidence levels) on some of the responses, especially the Left Knee Force and Yoke Displacement.



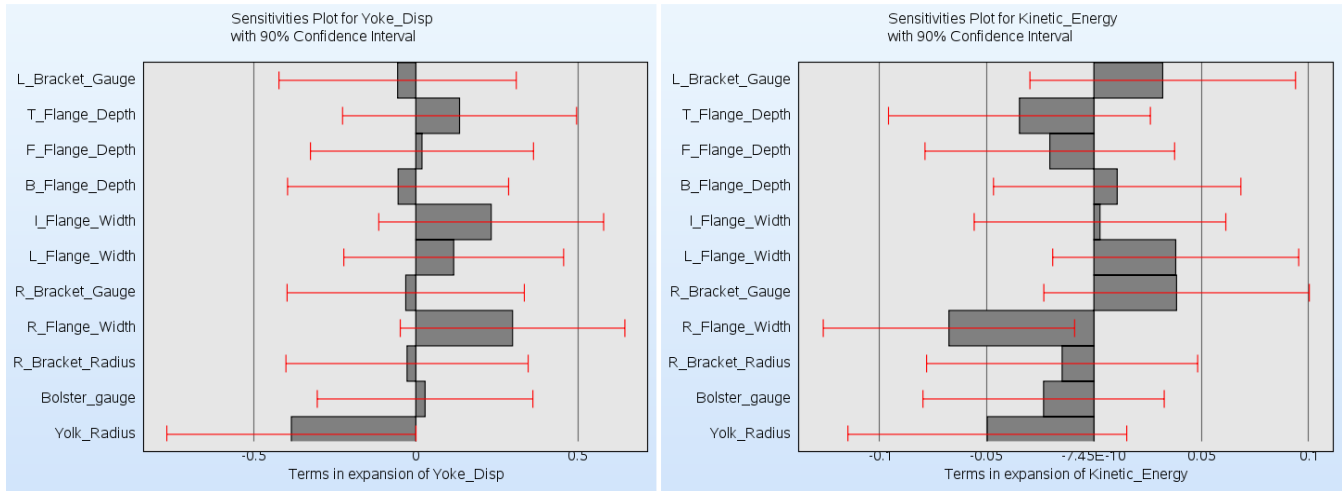


Figure 22-43: ANOVA plots for objectives and constraints of knee-bolster design problem.

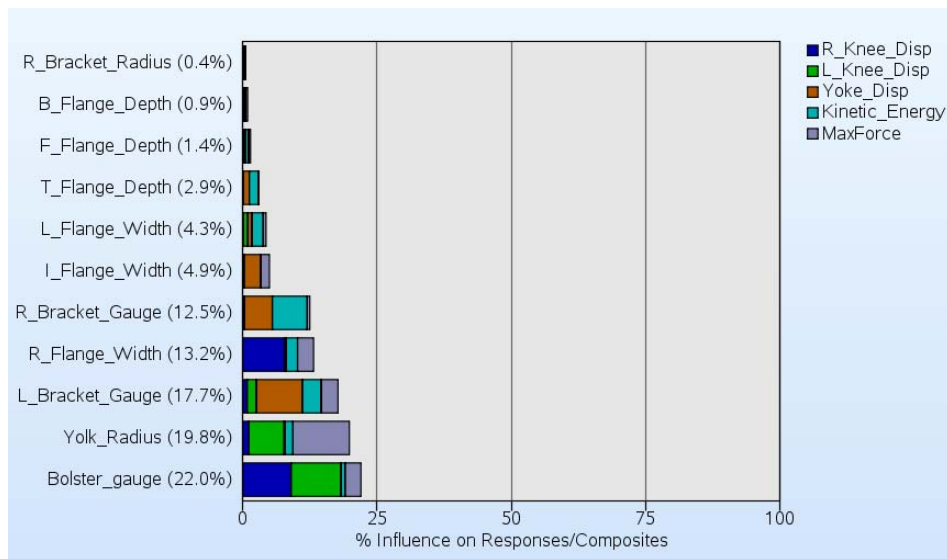


Figure 22-44: Global sensitivity analysis of objectives and constraints.

The six variables chosen from the charts are:

$$x=[Bolster\_gauge, Yoke\_Radius, L\_Bracket\_Gauge, R\_Bracket\_Gauge, R\_Flange\_Width, I\_Flange\_Depth]^T;$$

The changes in the input file are as follows:

```
variables 6
Variable 'L_Bracket_Gauge' .7
Lower bound variable 'L_Bracket_Gauge' .7
Upper bound variable 'L_Bracket_Gauge' 3.
Variable 'I_Flange_Width' 5.
Lower bound variable 'I_Flange_Width' 5.
Upper bound variable 'I_Flange_Width' 25.
Variable 'R_Bracket_Gauge' .7
Lower bound variable 'R_Bracket_Gauge' .7
Upper bound variable 'R_Bracket_Gauge' 3.
Variable 'R_Flange_Width' 20.
```

```
Lower bound variable 'R_Flange_Width' 20.  
Upper bound variable 'R_Flange_Width' 50.  
Variable 'Bolster_gauge' 3.6  
Lower bound variable 'Bolster_gauge' 1.  
Upper bound variable 'Bolster_gauge' 6.  
Variable 'Yolk_Radius' 2.  
Lower bound variable 'Yolk_Radius' 2.  
Upper bound variable 'Yolk_Radius' 8.  
$  
$ CONSTANTS  
$  
constants 5  
Constant 'T_Flange_Depth' 50  
Constant 'F_Flange_Depth' 20  
Constant 'B_Flange_Depth' 15  
Constant 'L_Flange_Width' 20  
Constant 'R_Bracket_Radius' 10
```

### 22.7.5. Optimization strategy

In contrast to the strategy of the full vehicle example, a sequential strategy in which, the region of interest is kept constant, is chosen. The reader is also referred to [5] for a discussion of the accuracy and purpose of the various sequential sampling strategies available in LS-OPT. LFOPC (the default algorithm) is chosen as the core solver because of the requirement to minimize the maximum knee force.

### 22.7.6. Optimization history results

The plots below show optimization history of the objectives, constraints and some responses. The simulations converged after three iterations. While the baseline design resulted in a maximum force of 1.315 units, the optimum design resulted in only 0.966 units of maximum force. Though intermediate results were infeasible, the final design was feasible.

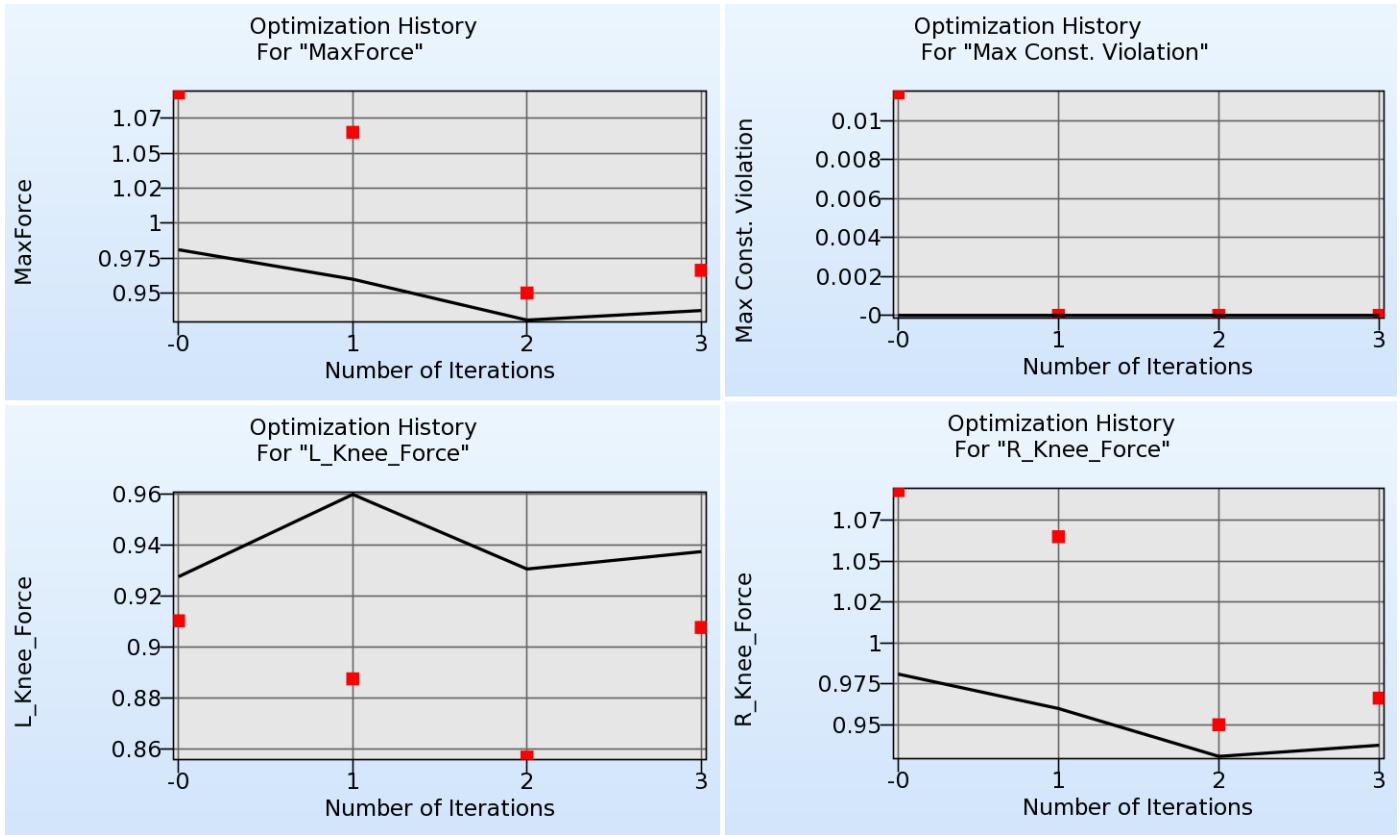


Figure 22-45: Optimization history of objectives and maximum constraint violations.

### 22.7.7. Summary of results

The following is an edited version of the `lsopt_report` file (also viewable by selecting View→Summary).

```

LS-OPT Version      : 4.1
LS-OPT Revision    : 57436
LS-OPT Version Date : Jan 6, 2010

Project Command File : com_srsn

*****
Problem description:
  Knee impact with 11 variables
*****

Continuous Variables
-----|-----|-----|
Variable Name   Lower Bound  Upper Bound
-----|-----|-----|
L_Bracket_Gauge      0.7          3
I_Flange_Width       5            25
R_Bracket_Gauge      0.7          3
R_Flange_Width       20           50
Bolster_gauge        1            6
Yolk_Radius          2            8
-----|-----|-----|

                C O N S T R A I N T   F U N C T I O N S
-----|-----|-----|
Constraint name           Lower Bound           Upper Bound
-----|-----|-----|

```

```
R_Knee_Disp      -1e+30    1
L_Knee_Disp      -1e+30    1
Yoke_Disp        -1e+30    1
Kinetic_Energy   -1e+30    1
```

-----  
 O P T I M I Z A T I O N A L G O R I T H M  
 -----

```
Method ..... Metamodel-based Optimization
Strategy ..... Sequential with Domain Reduction
Optimization Algorithm ..... Hybrid SA (Simulated Annealing + LFOPC)
```

```
=====
| Evaluating Starting Design |
| ITERATION 1                |
|-----|
```

C O M P U T E D v s . P R E D I C T E D  
 -----

Using Metamodel of Iteration 1

DESIGN POINT  
 -----

Variable Name	Lower Bound	Value	Upper Bound	
L_Bracket_Gauge	0.7	0.7	3	Active
I_Flange_Width	5	5	25	Active
R_Bracket_Gauge	0.7	0.7	3	Active
R_Flange_Width	20	20	50	Active
Bolster_gauge	1	3.6	6	
Yolk_Radius	2	2	8	Active

RESPONSE VALUES:  
 -----

Name	Computed	Predicted
L_Knee_Force	0.9102	0.9275
R_Knee_Force	1.093	0.981
R_Knee_Disp	0.8355	0.865
L_Knee_Disp	1.011	0.9917
Yoke_Disp	0.609	0.6354
Kinetic_Energy	0.3851	0.3586
Mass	0.6152	0.5795

COMPOSITE FUNCTIONS:  
 -----

COMPOSITE NAME	Computed	Predicted
MaxForce	1.093	0.981
Intrusion	0.9234	0.9284

OBJECTIVE:  
 -----

```
Computed Value = 1.093
Predicted Value = 0.981
```

OBJECTIVE VALUES:  
 -----

Name	Computed	Predicted	WT.
MaxForce	1.093	0.981	1

CONSTRAINT VALUES:  
 -----

Name	Computed	Predicted	Lower	Upper	Viol?
R_Knee_Disp	0.8355	0.865	-1e+30		1
L_Knee_Disp	1.011	0.9917	-1e+30		1
Yoke_Disp	0.609	0.6354	-1e+30		1
Kinetic_Energy	0.3851	0.3586	-1e+30		1



CONSTRAINT VIOLATIONS:

Name	Computed Violation		Predicted Violation	
	Lower	Upper	Lower	Upper
R_Knee_Disp	-	-	-	-
L_Knee_Disp	-	0.01141	-	-
Yoke_Disp	-	-	-	-
Kinetic_Energy	-	-	-	-

MAXIMUM VIOLATION:

Quantity	Computed		Predicted	
	Constraint	Value	Constraint	Value
Maximum Violation	L_Knee_Disp	0.01141	R_Knee_Disp	0
Smallest Margin	L_Knee_Disp	0.01141	L_Knee_Disp	0.008291

ERROR MEASURES FOR RESPONSES

ITERATION 3

Number of points = 42

Response Name	Metamodel type	RMS Error	RMS Error (% of mean)	Maximum Residual	Sq. Root PRESS	Sq. Root PRESS (% of mean)	R-Sq.	R-Sq. Predicted
L_Knee_Force	RBF Net	0.0896	6.93	0.249	0.143	11	0.891	0.818
R_Knee_Force	RBF Net	0.0402	3.18	0.093	0.0654	5.17	0.93	0.895
R_Knee_Disp	RBF Net	0.0232	2.8	0.0709	0.0322	3.89	0.811	0.732
L_Knee_Disp	RBF Net	0.0132	1.67	0.035	0.041	5.2	0.98	0.923
Yoke_Disp	RBF Net	0.202	30.3	0.691	0.244	36.6	0.281	0.167
Kinetic_Energy	RBF Net	0.0459	12.7	0.107	0.0531	14.6	0.434	0.461
Mass	RBF Net	0.0181	1.74	0.0514	0.0254	2.45	0.989	0.992

GLOBAL SENSITIVITY ESTIMATES

Cumulative Variable Influence [1]

Variable	AVERAGED		MAXIMUM	
	Main Effect	Total Effect	Main Effect	Total Effect
L_Bracket_Gauge	0.025	0.438	0.0511	0.591
I_Flange_Width	0.00728	0.15	0.0117	0.179
R_Bracket_Gauge	0.0484	0.552	0.11	0.82
R_Flange_Width	0.0383	0.498	0.0676	0.578
Bolster_gauge	0.045	0.445	0.129	0.669
Yolk_Radius	0.025	0.406	0.0498	0.515

FINAL DESIGN  
ITERATION 4

DESIGN POINT

Variable Name	Lower Bound	Value	Upper Bound	
L_Bracket_Gauge	0.7	0.7	3	Active
I_Flange_Width	5	24.97	25	
R_Bracket_Gauge	0.7	0.7015	3	Active
R_Flange_Width	20	20	50	Active

Bolster_gauge	1	5.156	6
Yolk_Radius	2	2	8 Active

RESPONSE VALUES:

Name	Computed	Predicted
L_Knee_Force	0.9076	0.9374
R_Knee_Force	0.9662	0.9374
R_Knee_Disp	0.8583	0.8518
L_Knee_Disp	0.8975	0.9037
Yoke_Disp	0.228	0.581
Kinetic_Energy	0.3965	0.3169
Mass	0.8054	0.8007

COMPOSITE FUNCTIONS:

COMPOSITE NAME	Computed	Predicted
MaxForce	0.9662	0.9374
Intrusion	0.8779	0.8777

OBJECTIVE:

Computed Value = 0.9662  
 Predicted Value = 0.9374

OBJECTIVE VALUES:

Name	Computed	Predicted	WT.
MaxForce	0.9662	0.9374	1

CONSTRAINT VALUES:

Name	Computed	Predicted	Lower	Upper	Viol?
R_Knee_Disp	0.8583	0.8518	-1e+30		1
L_Knee_Disp	0.8975	0.9037	-1e+30		1
Yoke_Disp	0.228	0.581	-1e+30		1
Kinetic_Energy	0.3965	0.3169	-1e+30		1

CONSTRAINT VIOLATIONS:

Name	Computed		Predicted	
	Lower	Upper	Lower	Upper
R_Knee_Disp	-	-	-	-
L_Knee_Disp	-	-	-	-
Yoke_Disp	-	-	-	-
Kinetic_Energy	-	-	-	-

MAXIMUM VIOLATION:

Quantity	Computed		Predicted	
	Constraint	Value	Constraint	Value
Maximum Violation	R_Knee_Disp	0	R_Knee_Disp	0
Smallest Margin	L_Knee_Disp	0.1025	L_Knee_Disp	0.09635

ANALYSIS COMPLETED

Tue Jan 12 12:17:44 2010

## 22.8. Optimization with analytical design sensitivities

This example demonstrates how analytical gradients (Section 13.10) provided by a solver can be used for optimization using the SLP algorithm and the domain reduction scheme [5] (Section 4.6). The solver, a Perl program is shown below, followed by the command file for optimization. In this example the input variables are read from the file: `XPoint` placed in the run directory by LS-OPT. The input variables can also be read by defining this file as an input file and using the `<<variable_name>>` format to label the variable locations for substitution. Note that each response requires a unique `Gradient` file.

### Solver program:

```
# Open output files for response results
#
open(FOUT, ">fsol");
open(G1OUT, ">g1sol");
open(G2OUT, ">g2sol");
#
# Output files for gradients
#
open(DF, ">Gradf");
open(DG1, ">Gradg1");
open(DG2, ">Gradg2");
#
# Open the input file "XPoint" (automatically
# placed by LS-OPT in the run directory)
#
open(X, "<XPoint");
#
# Compute results and write to the files
# (i.e. conduct the simulation)
#
while (<X>) {
    ($x1, $x2) = split;
}
#
print FOUT ($x1*$x1) + (4*($x2-0.5)*($x2-0.5)), "\n";
# Derivative of f(x1, x2)
#-----
print DF    (2*$x1), " ";          # df/dx1
print DF    (8*($x2-0.5)), "\n";  # df/dx2
#
print G1OUT $x1 + $x2, "\n";
# Derivative of g1(x1, x2)
#-----
print DG1 1, " ";
print DG1 1, "\n";
#
print G2OUT (-2*$x1) + $x2, "\n";
# Derivative of g2(x1, x2)
#-----
print DG2 -2, " ";
print DG2 1, "\n";
#
```

```
# Signal normal termination
#
print "N o r m a l\n";
```

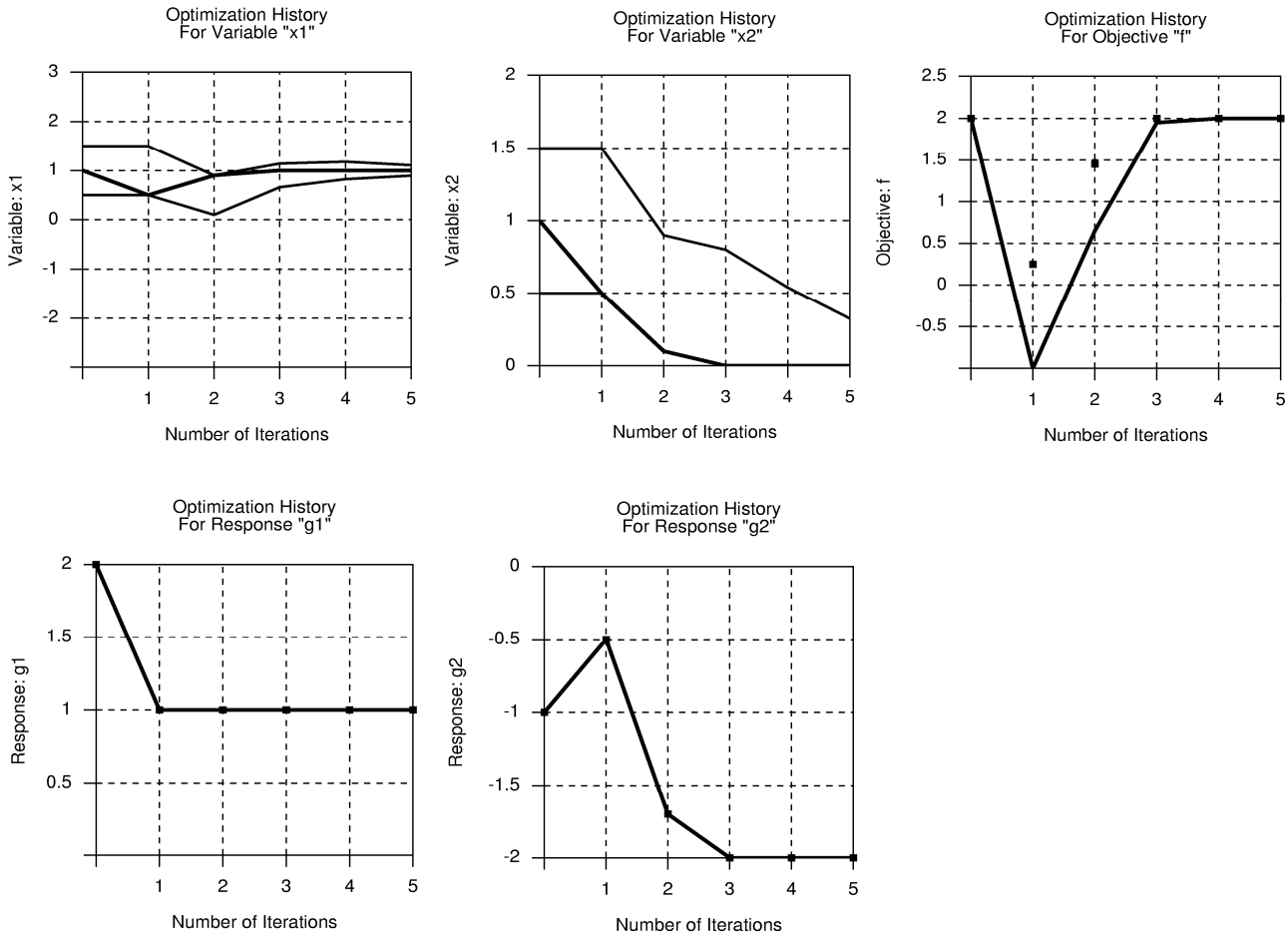
**Command file:**

```
"Example 2b: QP problem (analytical sensitivity analysis)"
solvers 1
responses 3
$
$ DESIGN VARIABLES
$
variables 2
Variable 'x1' 1
  Lower bound variable 'x1' -3
  Upper bound variable 'x1' 3
  Range 'x1' 1
Variable 'x2' 1
  Lower bound variable 'x2' 0
  Upper bound variable 'x2' 2
  Range 'x2' 1
$$$$$$$$$$$$$$$$$$$$$$$$$$$$$$$$$$$$$$$$
$      SOLVER "1"
$$$$$$$$$$$$$$$$$$$$$$$$$$$$$$$$$$$$$$$$
solver own '1'
  solver command "/home/LSOPT_EXE/perl ../../ex2"
  solver experimental design analytical_DSA
$
$ RESPONSES FOR SOLVER "1"
$ The Gradf, Gradg1 and Gradg2 files are individually copied to "Gradient"
  response 'f' 1 0 "cp Gradf Gradient; cat fsol"
  response 'g1' 1 0 "cp Gradg1 Gradient; cat g1sol"
  response 'g2' 1 0 "cp Gradg2 Gradient; cat g2sol"
$
$ OBJECTIVE FUNCTIONS
$
objectives 1
maximize
objective 'f' 1
$
$ CONSTRAINT DEFINITIONS
$
constraints 2
constraint 'g1'
  upper bound constraint 'g1' 1
constraint 'g2'
  upper bound constraint 'g2' 2
$
$ JOB INFO
$
iterate param design 0.01
iterate param objective 0.01
iterate param stoppingtype and
iterate 5
STOP
```

**Typical "Gradient" file (e.g. for f):**

1.8000000000 -3.2000000000

The optimization results are shown in the plots below. An iteration represents a single simulation. The dots represent the computed results while the solid line represents a linear approximation constructed from the gradient information of the previous point.



## 22.9. Probabilistic Analysis

### 22.9.1. Overview

This example has the following features:

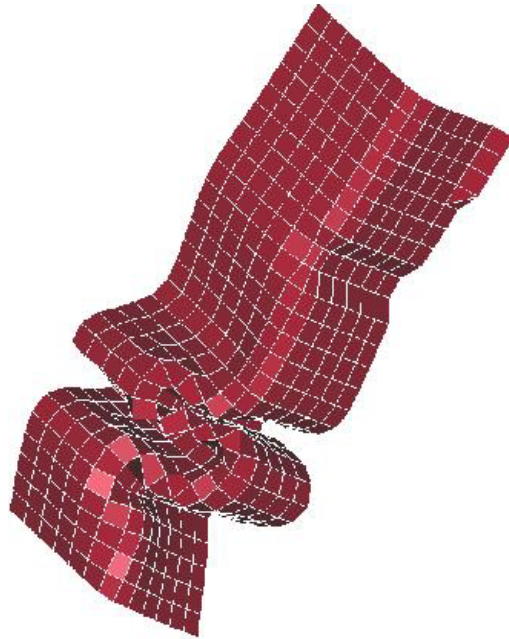
Probabilistic analysis

Monte Carlo analysis

Monte Carlo analysis using a metamodel

Bifurcations analysis

### 22.9.2. Problem description



*Figure 22-46: Tube impact*

A symmetric short crush tube impacted by a moving wall as shown in the figure is considered. The design criterion is the intrusion of the wall into the space initially occupied by the tube (alternatively, how much the structure is shortened by the impact with the wall).

Both the shell thickness and the yield strength of the structure follow a probabilistic distribution. The shell thickness is normally distributed around a value of 1.0 with a standard deviation of 5% while the yield strength is normally distributed around a value scaled to 1.0 with a standard deviation of 10%.

The nominal design has an intrusion of 144.4 units. The probability of the intrusion being greater than 150 units is computed. The best-known results are obtained using a Monte Carlo analysis of 1500 runs. The problem is analyzed using a Monte-Carlo evaluation of 60 runs and a quadratic response surface build using a  $3^k$  experimental design. The results from the different methods are close to each other as can be seen in the following table.

Response	Monte Carlo	Monte Carlo	Response Surface
	1500 runs	60 runs	9 runs
Average Intrusion	141.3	141.8	141.4
Intrusion Standard Deviation	15.8	15.2	15.0
Probability of Intrusion > 150	0.32	0.33	0.29

Using the response surface, the derivatives of the intrusions with respect to the design variables are computed as given in the following table.

Variable	Intrusion derivative
Shell Thickness	208
Yield Strength	107

The quadratic response surface also allows the investigation of the dependence of the response variation on each design variable variation. The values of the intrusion standard deviation given in the following table are computed considering the variable as the only source of variation in the structure (the variation of the other design variables are set to zero).

Source of variation	Intrusion Standard Deviation
Shell Thickness	10.4
Yield Strength	10.7

The details of the analyses are given the following subsections.

### 22.9.3. Monte Carlo evaluation

The probabilistic variation is described by specifying statistical distributions and assigning the statistical distributions to noise variables.

```
"Tube Crush Monte Carlo "
$ Created on Tue Apr 1 11:26:07 2003
solvers 1
$
distribution 2
  distribution 't' NORMAL 1.0 0.05
  distribution 'y' NORMAL 1.0 0.10
$
$ DESIGN VARIABLES
$
variables 2
  noise variable 'T1' distribution 't'
  noise variable 'YS' distribution 'y'
$
$ DEFINITION OF SOLVER "SOLVER_1"
$
  solver dyna960 'SOLVER_1'
  solver command "ls970.single"
  solver input file "tube.k"
  solver experiment design lhd centralpoint
  solver number experiments 60
$
$ HISTORIES FOR SOLVER "SOLVER_1"
$
histories 1
  history 'NHist' "BinoutHistory -res_type nodout -cmp z_displacement -id 486"
```

```

$
$ RESPONSES FOR SOLVER "SOLVER_1"
$
responses 2
  response 'NodDisp' 1 0 "BinoutResponse -res_type nodout -cmp z_displacement -id 486
-select MIN "
  response 'DispT' {LookupMin("NHist(t)")}
$
$
$
constraints 1
  constraint 'NodDisp'
  lower bound constraint 'NodDisp' -150
$
$ JOB INFO
$
  analyze monte carlo
STOP

```

The LS-OPT output:

```

#####
Direct Monte Carlo simulation considering 2 stochastic variables.
#####

```

```

#####
STATISTICS OF VARIABLES
#####

```

```

Variable 'T1'
Distribution Information
-----
Number of points   :      60
Mean Value        :      1
Standard Deviation : 0.04948
Coef of Variation  : 0.04948
Maximum Value     :    1.12
Minimum Value     :    0.8803

```

```

Variable 'YS'
Distribution Information
-----
Number of points   :      60
Mean Value        :      1
Standard Deviation : 0.09895
Coef of Variation  : 0.09895
Maximum Value     :    1.239
Minimum Value     :    0.7606

```

```

#####
STATISTICS OF RESPONSES

```



#####

Response 'NodDisp'  
 Distribution Information  
 -----  
 Number of points : 60  
 Mean Value : -141.8  
 Standard Deviation : 15.21  
 Coef of Variation : 0.1073  
 Maximum Value : -102.3  
 Minimum Value : -168.9

Response 'DispT'  
 Distribution Information  
 -----  
 Number of points : 60  
 Mean Value : 7.726  
 Standard Deviation : 0.6055  
 Coef of Variation : 0.07837  
 Maximum Value : 8.4  
 Minimum Value : 5.5

#####  
 STATISTICS OF COMPOSITES  
 #####

#####  
 STATISTICS OF CONSTRAINTS  
 #####

Constraint 'NodDisp'  
 Distribution Information  
 -----  
 Number of points : 60  
 Mean Value : -141.8  
 Standard Deviation : 15.21  
 Coef of Variation : 0.1073  
 Maximum Value : -102.3  
 Minimum Value : -168.9

Lower Bound:  
 -----  
 Bound ..... -150  
 Evaluations exceeding this bound ..... 20  
 Probability of exceeding bound ..... 0.3333  
 Confidence Interval on Probability.  
     Standard Deviation of Prediction Error: 0.06086  
     Lower Bound | Probability | Higher Bound  
           0.2116 | 0.3333 | 0.455  
     Confidence Interval of 95% assuming Normal Distribution  
     Confidence Interval of 75% using Tchebysheff's Theorem

Reliability Assuming Normal Distribution

Lower Bound:

```

-----
Bound ..... -150
Probability of exceeding Bound ... 0.2956
Reliability Index (Beta) ..... 0.5372

```

ANALYSIS COMPLETED

### 22.9.4. Monte Carlo using metamodel

The bounds on the design variables are set to be two standard distributions away from the mean (the default for noise variables). Noise variables are not used because of the need to have more control over the variable bounds — specifically we want to change the standard deviation of some variables without affecting the variable bounds (the metamodel is computed scaled with respect to the upper and lower bounds on the variables).

The command file for using a metamodel is:

```

$
"Tube Crush Metamodel Monte Carlo"
$ Created on Tue Apr 1 11:26:07 2003
solvers 1
$
distribution 2
distribution 't' NORMAL 1.0 0.05
distribution 'y' NORMAL 1.0 0.10
$
$ DESIGN VARIABLES
$
variables 2
variable 'T1' 1.0
upper bound variable 'T1' 1.1
lower bound variable 'T1' 0.9
variable 'T1' distribution 't'
variable 'YS' 1.0
upper bound variable 'YS' 1.2
lower bound variable 'YS' 0.8
variable 'YS' distribution 'y'
$
$ DEFINITION OF SOLVER "SOLVER_1"
$
solver dyna960 'SOLVER_1'
solver command "ls970.single"
solver input file "tube.k"
solver experiment design 3toK
solver order quadratic

```

```

$
$ HISTORIES FOR SOLVER "SOLVER_1"
$
histories 1
  history 'NHist' "BinoutHistory -res_type nodout -cmp z_displacement -id 486"
$
$ RESPONSES FOR SOLVER "SOLVER_1"
$
responses 2
  response 'NodDisp' 1 0 "BinoutResponse -res_type nodout -cmp z_displacement -id 486 -
  select MIN"
  response 'DispT' {LookupMin("NHist(t)")}
$
$
$
  constraints 1
    constraint 'NodDisp'
    lower bound constraint 'NodDisp' -150.0
$
$ JOB INFO
$
  analyze metamodel monte carlo
STOP

```

The accuracy of the response surface is of interest:

Approximating Response 'NodDisp' (ITERATION 1)

-----  
Polynomial approximation: using 9 points

Global error parameters of response surface  
-----

Quadratic Function Approximation:  
-----

Mean response value	=	-142.0087
RMS error	=	2.0840 (1.47%)
Maximum Residual	=	3.3633 (2.37%)
Average Error	=	1.6430 (1.16%)
Square Root PRESS Residual	=	6.2856 (4.43%)
Variance	=	13.0296
R <sup>2</sup>	=	0.9928
R <sup>2</sup> (adjusted)	=	0.9856
R <sup>2</sup> (prediction)	=	0.9346

The probabilistic evaluation results:

```

#####
Monte Carlo simulation considering 2 stochastic variables.
Computed using 1000000 simulations
#####

```

-----  
 Results for reliability analysis using approximate functions  
 -----

#####  
 STATISTICS OF VARIABLES  
 #####

Variable 'T1'

Distribution Information

-----  
 Number of points : 1000000  
 Mean Value : 1  
 Standard Deviation : 0.04997  
 Coef of Variation : 0.04997  
 Maximum Value : 1.227  
 Minimum Value : 0.7505

Variable 'YS'

Distribution Information

-----  
 Number of points : 1000000  
 Mean Value : 1  
 Standard Deviation : 0.09994  
 Coef of Variation : 0.09994  
 Maximum Value : 1.472  
 Minimum Value : 0.5187

#####  
 STATISTICS OF RESPONSES  
 #####

Response 'NodDisp'

Distribution Information

-----  
 Number of points : 1000000  
 Mean Value : -141.4  
 Standard Deviation : 14.95  
 Coef of Variation : 0.1058  
 Maximum Value : -68.5  
 Minimum Value : -206.3

Response 'DispT'

Distribution Information

-----  
 Number of points : 1000000  
 Mean Value : 7.68  
 Standard Deviation : 0.546  
 Coef of Variation : 0.0711  
 Maximum Value : 9.267  
 Minimum Value : 2.565

```
#####
STATISTICS OF COMPOSITES
#####
```

```
#####
STATISTICS OF CONSTRAINTS
#####
```

```
Constraint 'NodDisp'
Distribution Information
-----
Number of points      : 1000000
Mean Value            : -141.4
Standard Deviation    : 14.95
Coef of Variation     : 0.1058
Maximum Value         : -68.5
Minimum Value         : -206.3
```

Lower Bound:

```
-----
Bound ..... -150
Evaluations exceeding this bound ..... 285347
Probability of exceeding bound ..... 0.2853
Confidence Interval on Probability.
Standard Deviation of Prediction Error: 0.0004516
Lower Bound | Probability | Higher Bound
0.2844 | 0.2853 | 0.2863
Confidence Interval of 95% assuming Normal Distribution
Confidence Interval of 75% using Tchebysheff's Theorem
```

ANALYSIS COMPLETED

### 22.9.5. Bifurcation analysis

A bifurcation analysis of the tube is conducted as described in Section 6.6, Section 21, and Example 22.10. The resulting buckling modes found for the metamodel-based analysis are as shown in Figure 22-47. An extra half wave is formed for the one design.

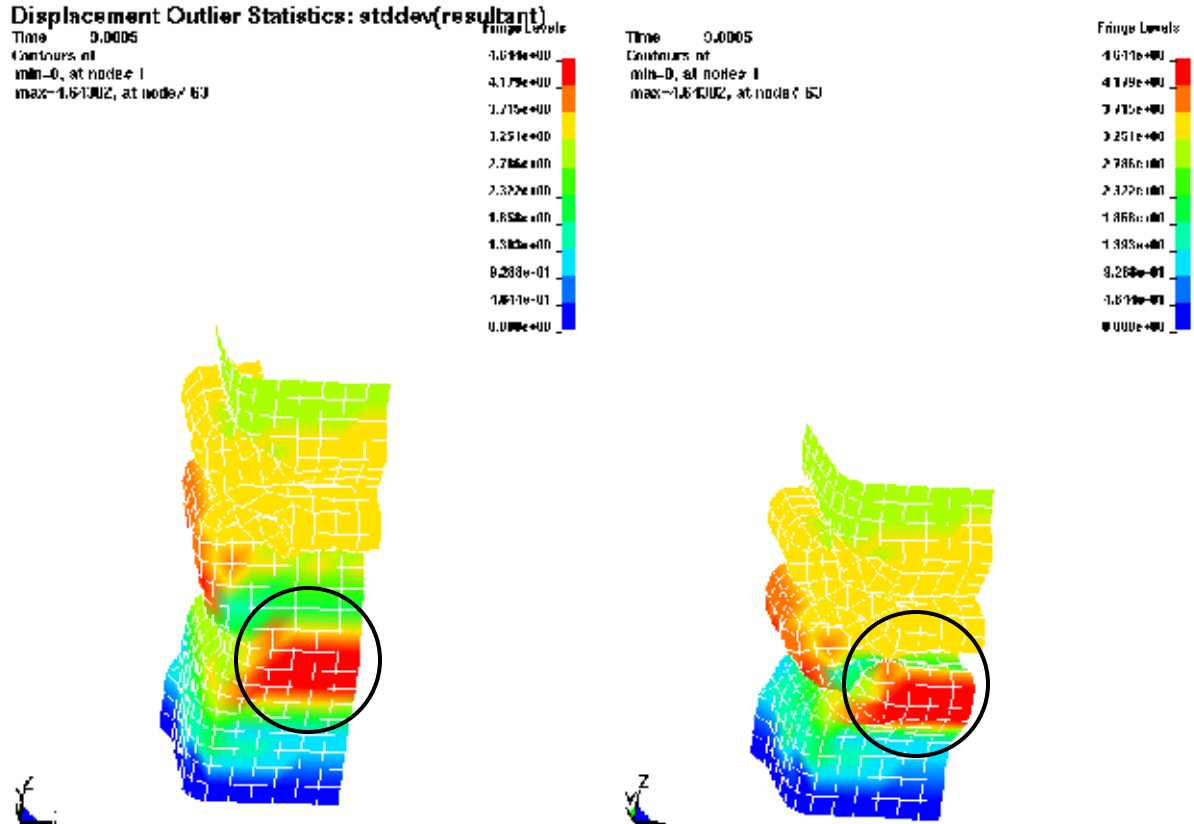


Figure 22-47 Tube Buckling

## 22.10. Bifurcation/Outlier Analysis

### 22.10.1. Overview

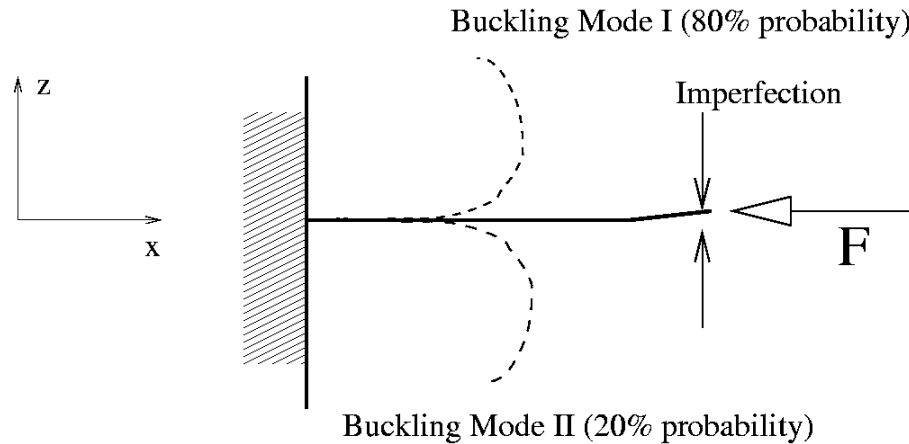
This example has the following features:

Monte Carlo analysis

Identification of different buckling modes in the structure

### 22.10.2. Problem description

The plate as shown in Figure 22-48 has two buckling modes. Buckling in the positive z-direction occurs with a probability of 80% while buckling in the negative z-direction occurs with a probability of 20%. The statistical distribution of the tip nodes imperfection controls the probability of buckling.



**Figure 22-48 Plate Buckling Example**

### Monte Carlo evaluation

A Latin hypercube experimental design is used for the Monte Carlo analysis. We analyze only five points. Given that the probability of 20% of buckling in the negative  $z$ -direction and a Latin hypercube experimental design, one run will buckle in the negative  $z$ -direction. The next section will demonstrate how to find out which run contains the different buckling mode.

```
"Monte Carlo Analysis; 2 buckling modes"
$
solvers 1
$
distribution 1
  distribution 'i' UNIFORM -0.001 0.004
$
$ DESIGN VARIABLES
$
variables 1
  noise variable 'Imp' distribution 'i'
$
$
$ SOLVER_1
$
solver dyna960 'SOLVER_1'
  solver command "ls970.single"
  solver input file "plate.k"
  solver experiment design lhd centralpoint
  solver number experiments 5
$
$ RESPONSES
$
responses 4
  response 'tip_x' 1 0 "BinoutResponse -res_type nodout -cmp x_displacement -id 12 -
select TIME "
  response 'tip_y' 1 0 "BinoutResponse -res_type nodout -cmp y_displacement -id 12 -
select TIME "
  response 'tip_z' 1 0 "BinoutResponse -res_type nodout -cmp z_displacement -id 12 -
```

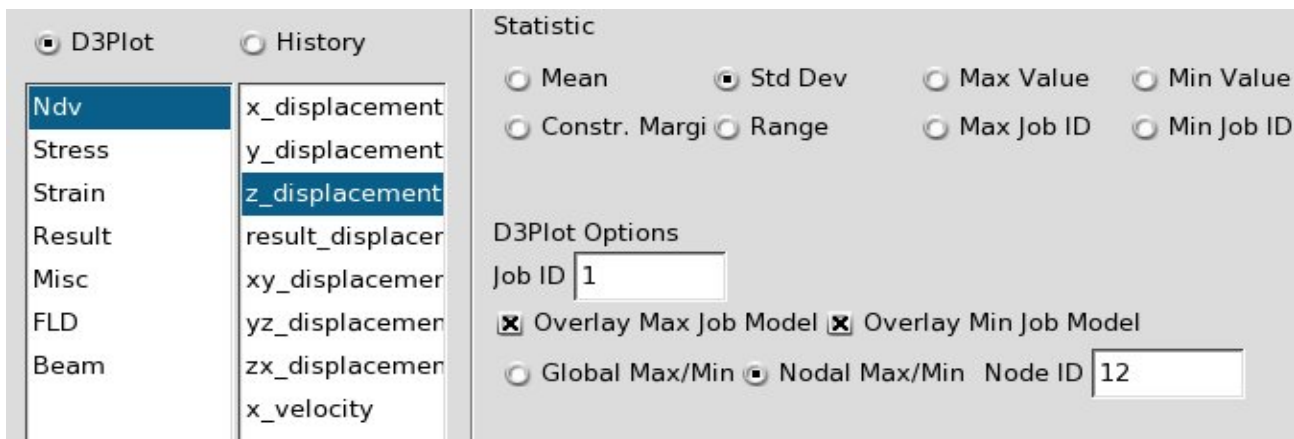
```

select TIME "
  response 'tip_r' 1 0 "BinoutResponse -res_type nodout -cmp displacement -invariant
MAGNITUDE -id 12 -select TIME "
$
$
$ JOB
$
  analyze monte carlo
STOP

```

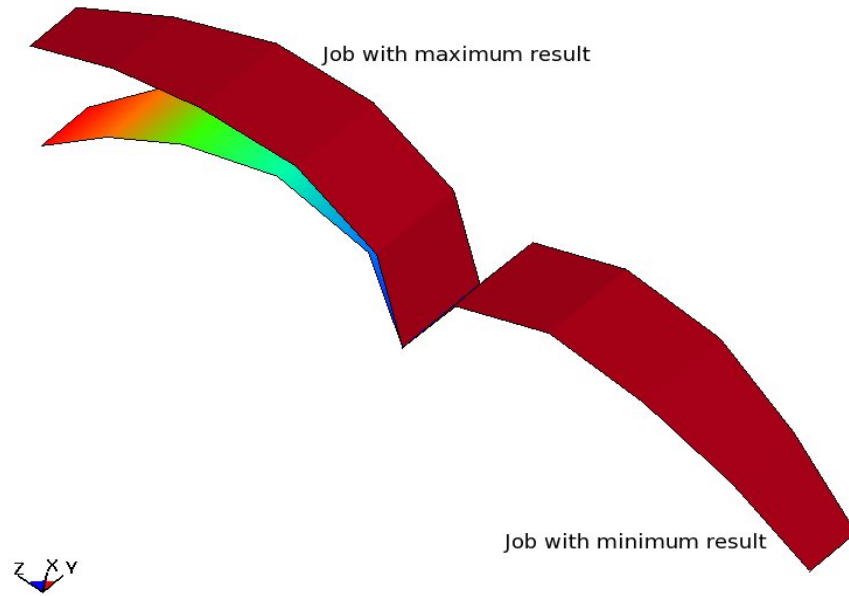
### 22.10.3. Automatic identification of buckling modes

Different buckling modes can be identified automatically and displayed in LS-PREPOST. To identify bifurcations, we display the FE jobs having the extreme values. For this structure, either the global extreme z-displacement or the tip z-displacement can be considered in order to identify the bifurcation. Automated identification of the bifurcation is done in the GUI as shown in Figure 22-49 with the bifurcation as displayed using LS-PREPOST as shown in Figure 22-50. Some background on bifurcation identification can be found in Section 21.10. A more user-intensive procedure is described in the next section.



*Figure 22-49 Selecting the automated identification of a bifurcation. The user must (i) select to overlay the FE models associated with the maximum and minimum residual and (ii) choose whether the residual is the global residual or a residual at a specific node.*





*Figure 22-50 LS-OPT identified and displayed this bifurcation automatically using the GUI setting shown in the previous figure.*

#### 22.10.4. Manual identification of buckling modes

The different buckling modes are identified using the DYNA Stats panel in LS-OPT.

Next, LS-PREPOST can be launched to investigate the range (or standard deviation) of all the displacement components. From the displacement resultant plot, amongst others, it is clear that the bifurcation is at the tip. Looking at the other component plots, we find the z-displacement has a range of 5.3 and the x-displacement a range of 4.5. The displacement magnitude computed using the maximum vector has a range of 6.9.

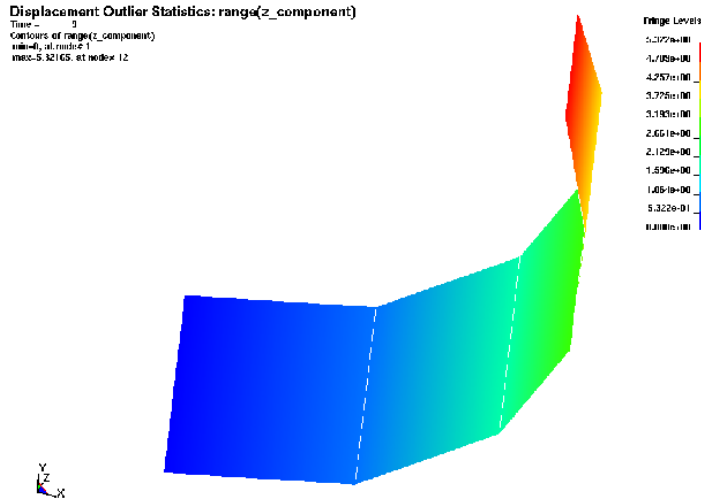


Figure 22-51 Range of z-component displacement

Either the z-displacement or the maximum vector displacement magnitude can therefore be used to identify the buckling modes. Fringe plots of the run index of the maximum and minimum displacement identifies the runs as 2 and 4.

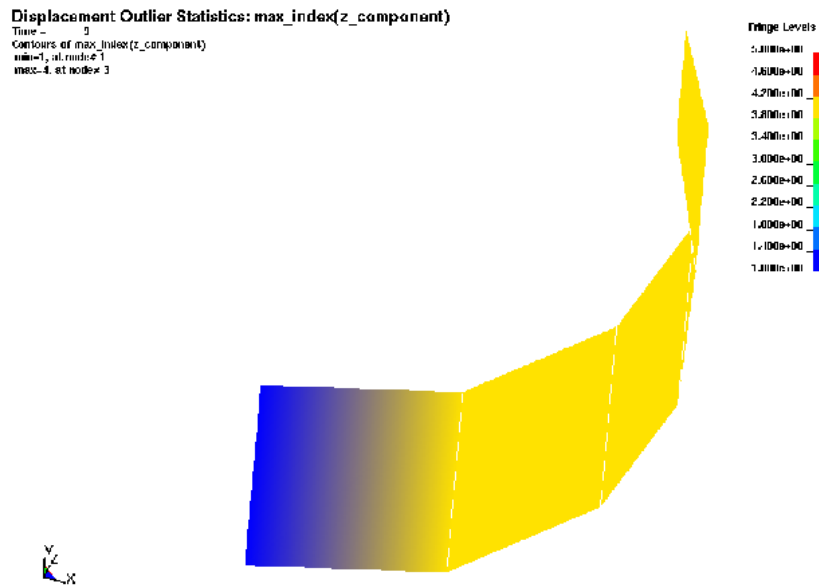


Figure 22-52 Index of run with maximum z-component displacement

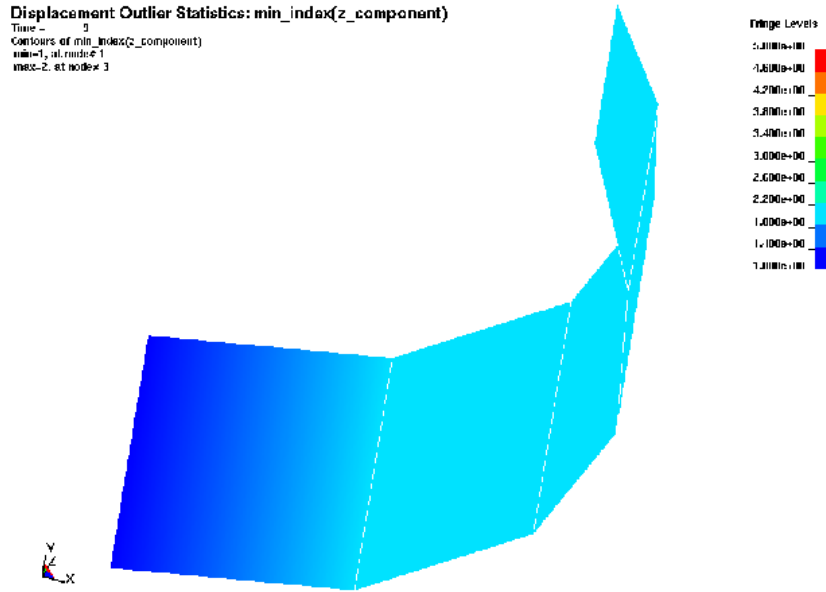


Figure 22-53 Index of run with minimum z-component displacement

LS-OPT allows you to specify the job number to use for the LS-PREPOST plot. Plotting the results of run 2 and 4 we find the second buckling mode as:

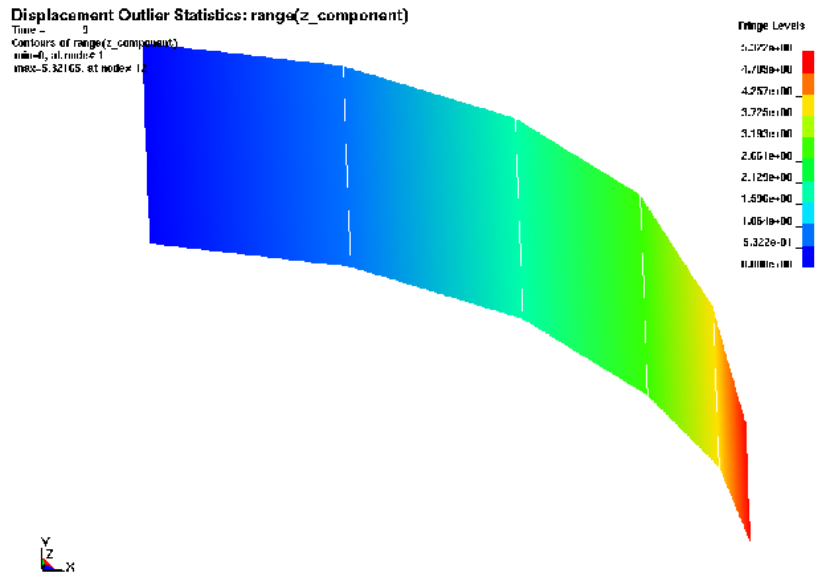
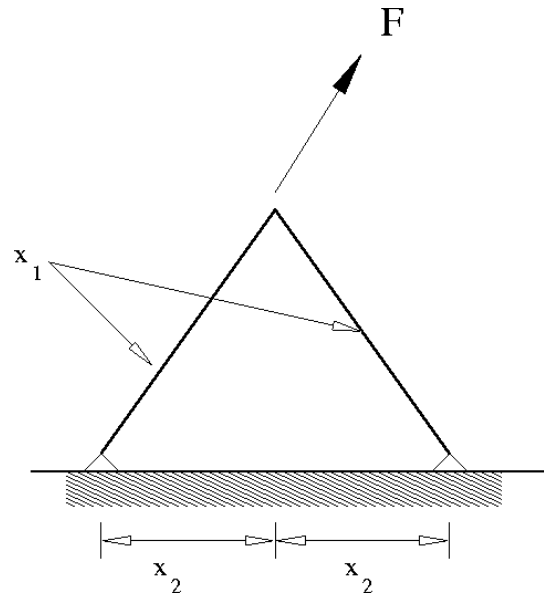


Figure 22-54 Second buckling mode

## 22.11. Robust Parameter Design

Consider the two-bar truss problem as shown in Figure 22-55. Variable  $x_1$ , the area, is a noise variable described using a normal distribution with a mean of 2.0 and a standard deviation of 0.1. The distance between the legs,  $x_2$ , is a control variable which will be adjusted to control the variance of the responses. The maximum stress is considered as the objective for the robust design process.



**Figure 22-55** The two-bar truss problem. The problem has two variables: the thickness of the bars and the leg widths as shown. The bar thicknesses are noise variables while the leg widths are adjusted (control variables) to minimize the effect of the variation of the bar thicknesses. The maximum stress in the structure is monitored.

A response surface considering the effect of variables and the interaction between variables is used to approximate the stress response.

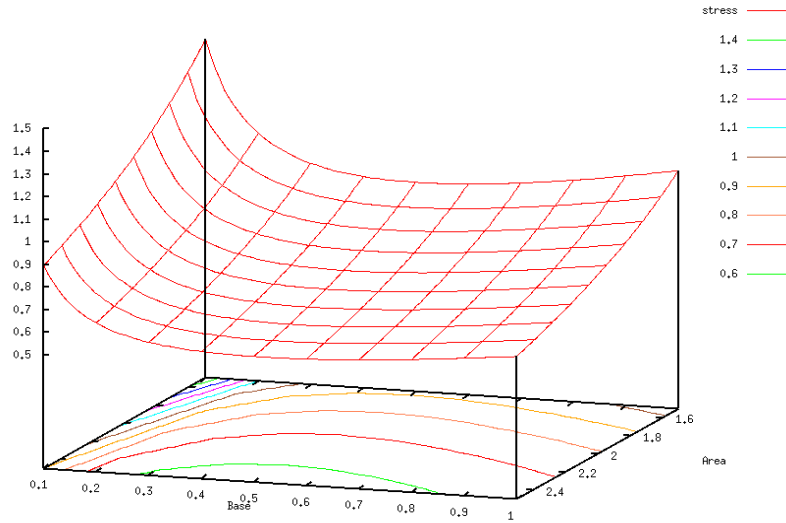
```
"Two-bar Truss"
$
solvers 1
responses 2
$
$ PROBABILISTIC DISTRIBUTIONS
$
distribution 1
  distribution 'area' NORMAL 2.0 0.1
$
$ DESIGN VARIABLES
$
variables 2
  Noise variable 'Area' distribution 'area'
  Variable 'Base' 0.8
    Lower bound variable 'Base' 0.1
    Upper bound variable 'Base' 1.6
    Range 'Base' 1.6
```

```

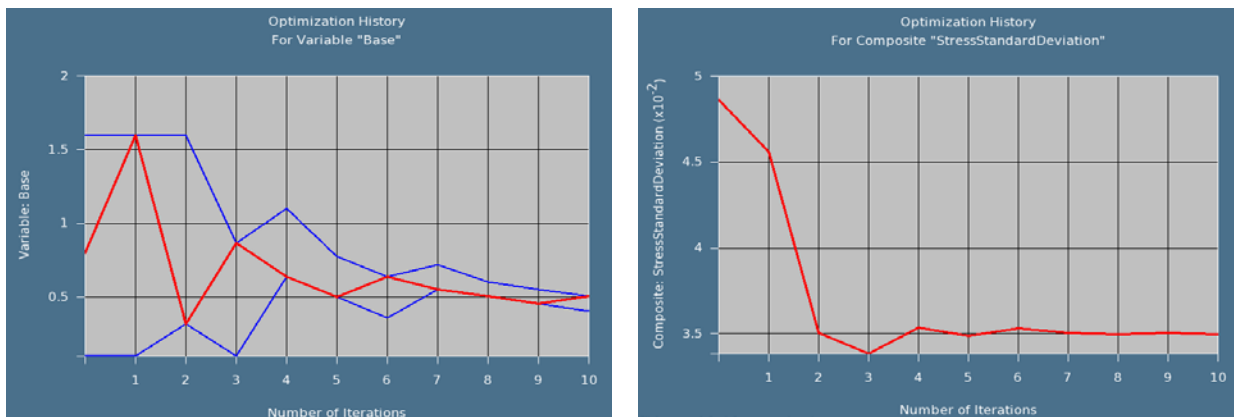
$$$$$$$$$$$$$$$$$$$$$$$$$$$$$$$$$$$$$$$$
$      SOLVER "SOLVER_1"
$$$$$$$$$$$$$$$$$$$$$$$$$$$$$$$$$$$$$$$$
$
$ DEFINITION OF SOLVER "SOLVER_1"
$
  solver own 'SOLVER_1'
  solver command "echo N o r m a l"
$ ----- Pre-processor -----
$   NO PREPROCESSOR SPECIFIED
$ ----- Metamodeling -----
  solver order interaction
  solver experiment design 3toK
$ ----- Job information -----
  solver concurrent jobs 1
$
$ RESPONSE EXPRESSIONS FOR SOLVER "SOLVER_1"
$
  response 'Weight' expression { Area * sqrt(1+Base*Base) }
  response 'Stress' expression { 0.124 * sqrt(1+Base*Base) * (8/Area + 1./Area/Base) }
$
composites 1
$
$ STD DEV COMPOSITES
$
  composite 'StressStandardDeviation' noise 'Stress'
$
$ OBJECTIVE FUNCTIONS
$
  objectives 1
  objective 'StressStandardDeviation' 1
$
$ CONSTRAINT DEFINITIONS
$
  constraints 0
$
$ JOB INFO
$
  iterate param design 0.01
  iterate param objective 0.01
  iterate param stoppingtype and
  iterate 10
STOP

```

The stress response is shown in Figure 22-56. From the figure it can be seen that the ‘base’ variable must be set to values of large than 0.4 to obtain a minimum variation of the stress considering that the design will then be in the flattest region of the response. A value of 0.5 is obtained in the optimization results as shown in Figure 22-57. Also shown in the optimization results is the design history of the stress standard deviation. Note that the standard deviation response stayed fairly insensitive to changes in the control variable after iteration 4 and that the initial subregion size for the ‘base’ variable was too large, resulting in initial increase in ‘base’ variable due to an inaccurate initial response surface.



**Figure 22-56** Contours of stress response. The flattest part of the response is when variable 'base' equals 0.5.



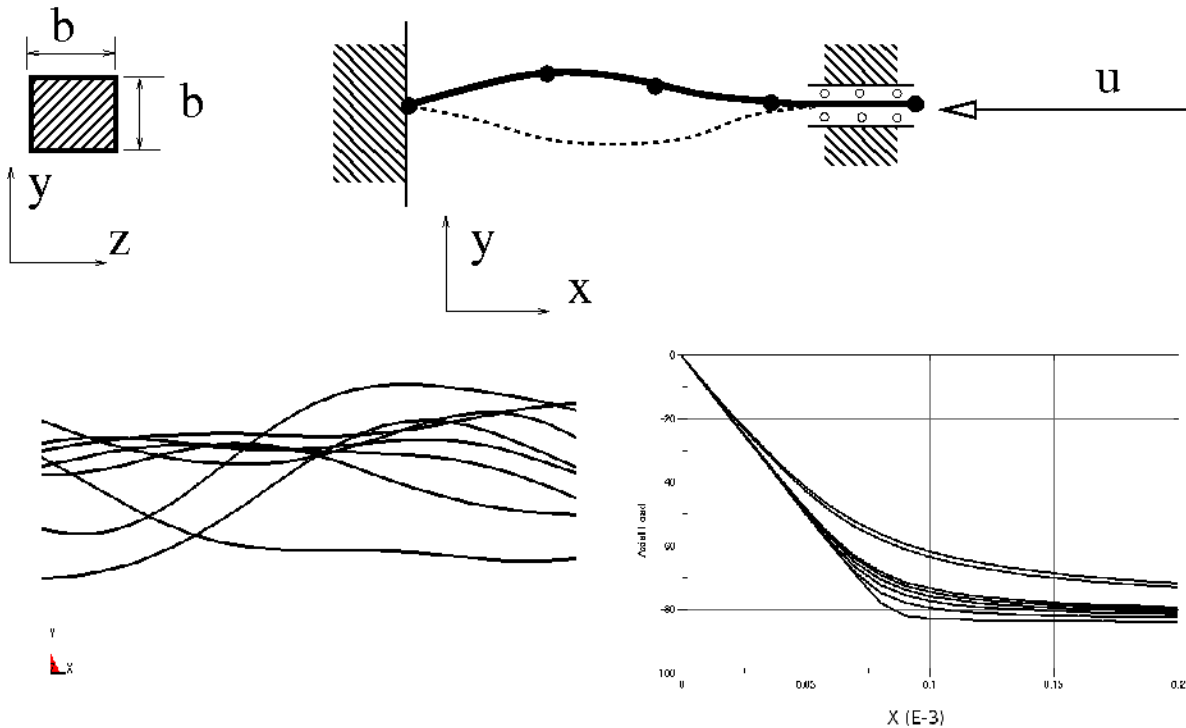
**Figure 22-57** Optimization histories. Design variable 'base' is shown on the left and the standard deviation of the stress response is shown on the right.

## 22.12. Using Stochastic Fields

This example demonstrates:

- Using a stochastic field in a Monte Carlo analysis
- Using a variable and a stochastic field in a Monte Carlo analysis
- Doing replicate experiments using stochastic fields
- Using fixed stochastic fields

The structure as shown in the Figure 22-58 is considered. This is the compression of a beam with geometrical imperfections modeled using a stochastic field. The result considered is the load at the end of the analysis as shown in the figure.



**Figure 22-58 Problem with a stochastic field. The structural problem is shown in the top. In the bottom left are sample beams with the perturbation exaggerated by a factor 100, and the corresponding histories are shown in the bottom right.**

The beam has a length of 20 and a Young's modulus of 2e8. It is analyzed in using 128 type 2 beam elements using an implicit analysis and 20 increments to compress the end a distance of -0.002.

The perturbation is created using the spectral method to have an autocorrelation function described by a Gaussian correlation function. The Gaussian correlation function is  $P(x) = e^{-(ax)^2}$  with s distance and the constant  $a = 0.1$  in this study. The resulting perturbation is scaled by 0.01. The LS-DYNA®

\*PERTURABATION card is:

```
*PERTURBATION_NODE
$type, nid, scl, cmp, icoord, cid
4, , 1.e-2, 3
$stype, e1, e2, rnd
1, , ,
1, 1.e-1
```

## Using only a stochastic field

Firstly, a Monte Carlo analysis is done considering only the geometric stochastic fields. The stochastic field is set to vary freely using the LS-DYNA<sup>®</sup> keyword. Every LS-OPT analysis needs a variable, so we added a dummy variable that does not do anything. Note that it is possible to have a variable controlling the random seed in the LS-DYNA<sup>®</sup> \*PARAMETER keyword, which can be useful for many reasons, such as having only certain stochastic fields.

The LS-OPT<sup>®</sup> input deck used is:

```
$
solvers 1
responses 2
histories 1
$
$ PROBABILISTIC DISTRIBUTIONS
$
distribution 1
  distribution 'UNIFORM1' UNIFORM 0 1
$
$ DESIGN VARIABLES
$
variables 1
  Noise variable 'dummy' distribution 'UNIFORM1'
$
$ CONSTANTS
$
constants 2
  Constant 'b' 0.1
  Constant 'dt' 0.0001

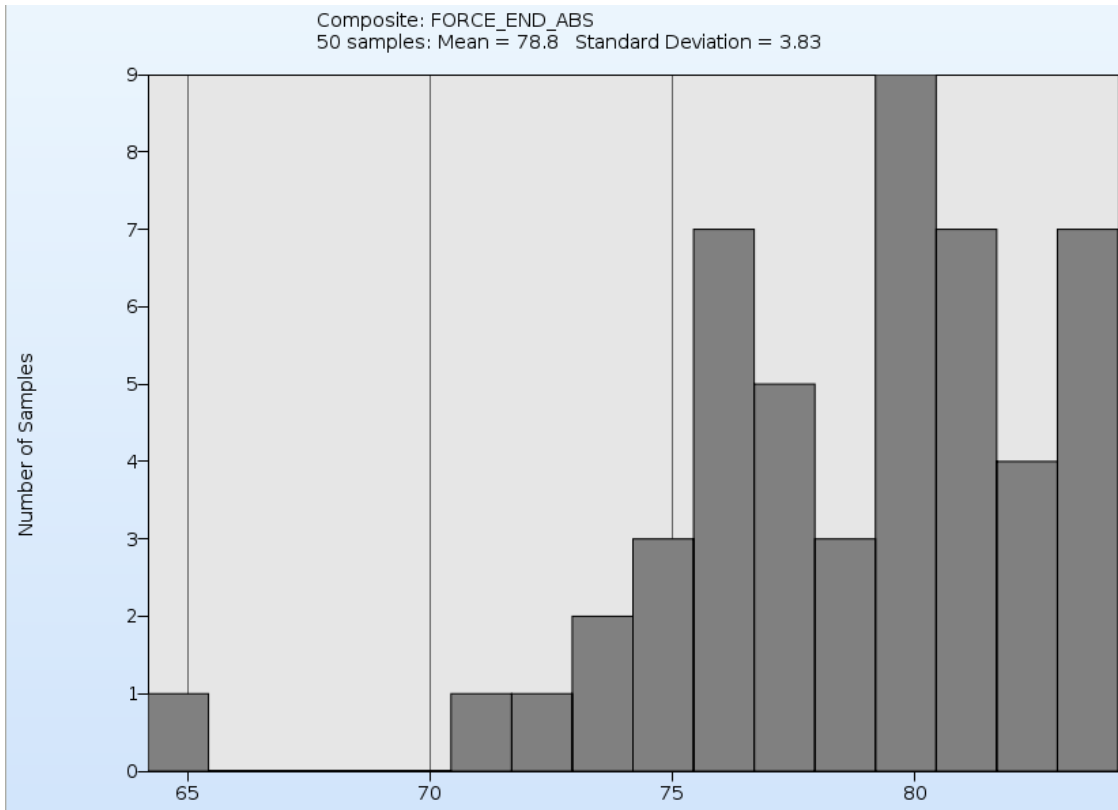
$$$$$$$$$$$$$$$$$$$$$$$$$$$$$$$$$$$$$$$$
$   SOLVER "SOLVER_1"
$$$$$$$$$$$$$$$$$$$$$$$$$$$$$$$$$$$$$$$$
$
$ DEFINITION OF SOLVER "SOLVER_1"
$
  solver dyna960 'SOLVER_1'
    solver command "ls971.double.dev"
    solver input file "beam_spert.k"
    solver check output on
    solver compress d3plot off
$ ----- Pre-processor -----
$   NO PREPROCESSOR SPECIFIED
$ ----- Post-processor -----
$   NO POSTPROCESSOR SPECIFIED
$ ----- Metamodeling -----
  solver experiment design monte_carlo
  solver number experiments 50
$ ----- Job information -----
  solver concurrent jobs 1
$
$ RESPONSES FOR SOLVER "SOLVER_1"
$
  response 'FORCE_END' 1 0 "BinoutResponse -res_type bndout -cmp x_total -id 129 -sub
velocity/nodes -select TIME "
```



```
response 'BNDOUT_xtotal_end' 1 0 "BinoutResponse -res_type bndout -cmp x_total -id
129 -sub velocity/nodes -select TIME "
$
$ HISTORIES FOR SOLVER "SOLVER_1"
$
history 'BNDOUT_xtotal' "BinoutHistory -res_type bndout -cmp x_total -id 129 -sub
velocity/nodes"

composites 1
$
$ COMPOSITE EXPRESSIONS
$
composite 'FORCE_END_ABS' {abs(FORCE_END)}
$
$ NO OBJECTIVES DEFINED
$
objectives 0
$
$ THERE ARE NO CONSTRAINTS
$
constraints 0
$
$ JOB INFO
$
analyze monte carlo
STOP
```

The histogram of the responses is shown in Figure 22-59. Note that the distribution has a characteristic shape.



*Figure 22-59 Histogram of the responses using only a stochastic field.*

### 22.12.1. A variable and a stochastic field

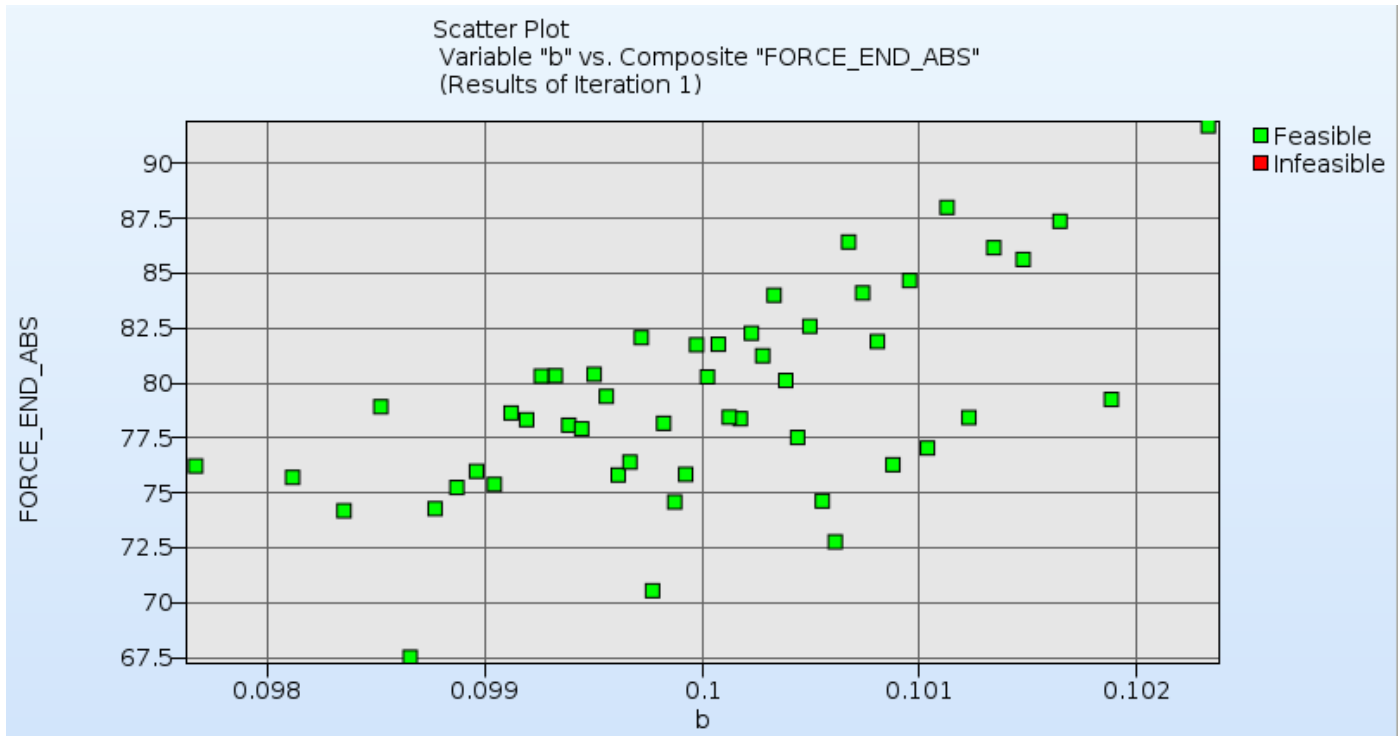
In this example a variable as well as the stochastic field are used to do the analysis.

The variable and experimental design statements are modified as below:

```

$
distribution 1
  distribution 'N001' NORMAL 0.1 0.001
$
$ DESIGN VARIABLES
$
variables 1
  Noise variable 'b' distribution 'N001'
$
  solver experiment design space_filling
  solver number experiments 50

```



**Figure 22-60** Plot of the responses using the thickness variable and a stochastic field.

### 22.12.2. Replicate experiments using stochastic fields

In this example a variable as well as the stochastic field are used to do the analysis. Replicate runs are done at each experimental point with different values of the stochastic field.

In LS-DYNA, we add the random seed of the stochastic field as a variable. We let it vary freely by setting the seed to zero:

```
*PARAMETER
irand, 0
$
*PERTURBATION_NODE
$type, nid, scl, cmp, icoord, cid
4, , 1.e-2, 3,
$stype, e1, e2, rnd
1, , , &rand
$
1, 1.e-1
$
```

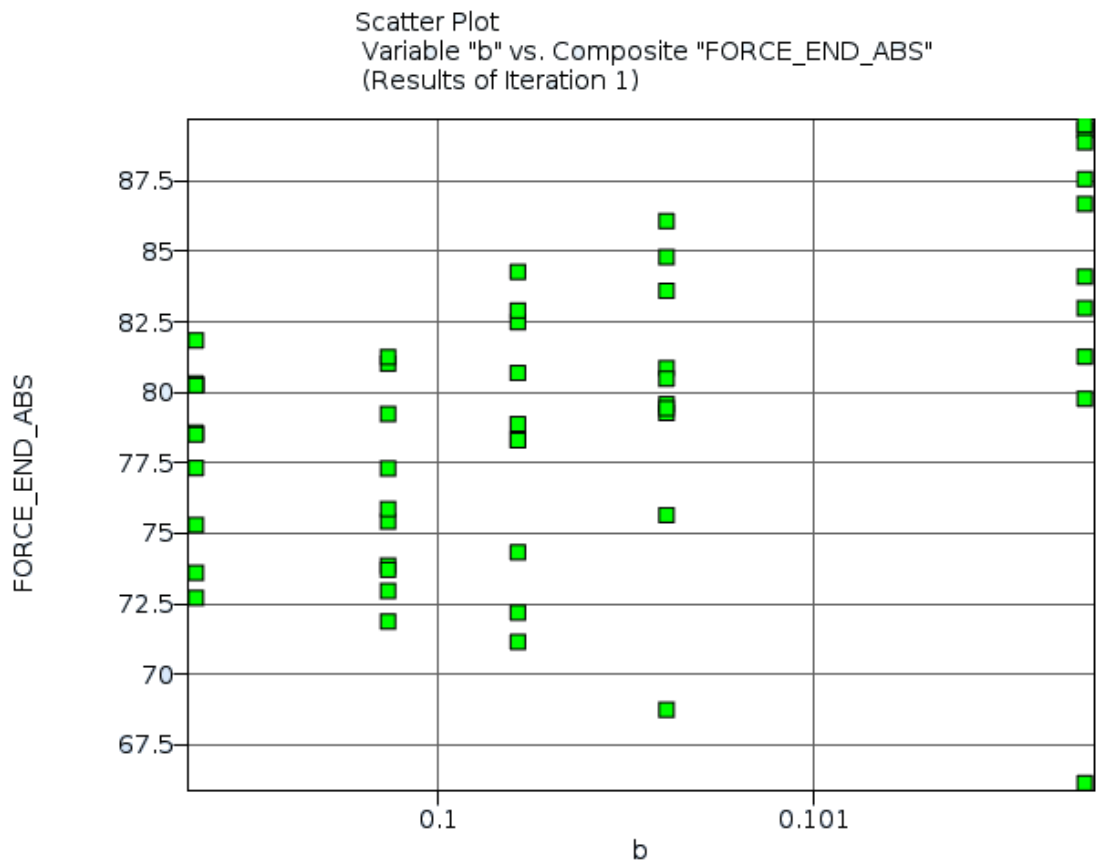
In LS-OPT we use replicate experiments to analyze. The required modifications to the LS-OPT command file are as below:

```

distribution 1
  distribution 'N001' NORMAL 0.1 0.001
$
$ DESIGN VARIABLES
$
variables 1
  Noise variable 'b' distribution 'N001'
$
$ CONSTANTS
$
constants 1
  Constant 'rand' 0$

solver experiment design monte carlo
solver number experiments 5
solver number replicate experiments 10

```



*Figure 22-61 Plot of the responses using replicate experiments*

### 22.12.3. Using fixed stochastic fields

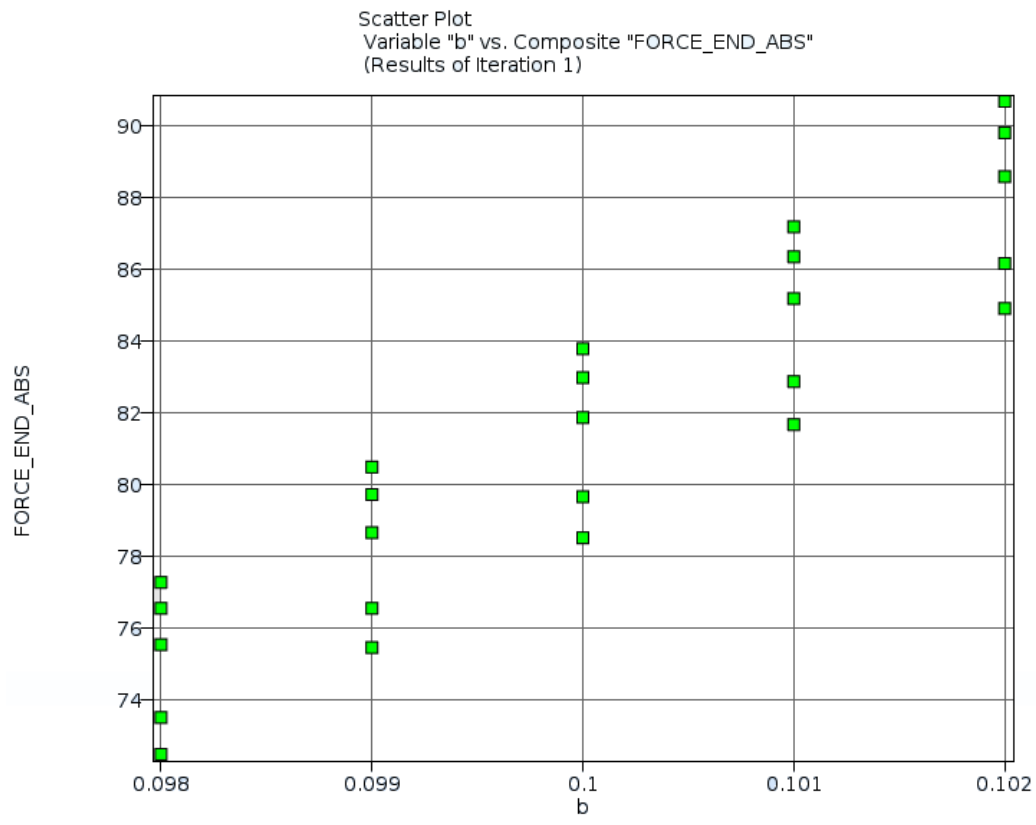
In this example a variable as well as the stochastic field are used to do the analysis. Replicate runs are done at each experimental point with the same stochastic fields. By using the seed for the stochastic field as a variable, we are able to specify the stochastic field used.

The required modifications to the LS-OPT command file are:

```
distribution 1
distribution 'N001' NORMAL 0.1 0.001
$
$
variables 2
noise variable 'b' distribution 'N001'
variable 'rand' 3.
variable 'rand' discrete {1. 2. 3. 4. 5. }

solver experiment design 5toK

Analyze metamodel monte carlo
```



*Figure 22-62 Plot of the responses using the same five stochastic fields in the replicates.*

## 22.13. REFERENCES

- [1] Yamazaki, K., Han, J., Ishikawa, H., Kuroiwa, Y. Maximation of crushing energy absorption of cylindrical shells – simulation and experiment, Proceedings of the OPTI-97 Conference, Rome, Italy, September 1997.
- [2] Craig K.J., Stander, N., Dooge, D., Varadappa, S. MDO of automotive vehicle for crashworthiness and NVH using response surface methods. Paper AIAA2002\_5607, 9th AIAA/ISSMO Symposium on Multidisciplinary Analysis and Optimization, 4-6 Sept 2002, Atlanta, GA.
- [3] National Crash Analysis Center (NCAC). Public Finite Element Model Archive, [www.ncac.gwu.edu/archives/model/index.html](http://www.ncac.gwu.edu/archives/model/index.html) 2001.
- [4] Akkerman, A., Thyagarajan, R., Stander, N., Burger, M., Kuhn, R., Rajic, H. Shape optimization for crashworthiness design using response surfaces. Proceedings of the 1st International Workshop on Multidisciplinary Design Optimization, Pretoria, South Africa, 8-10 August 2000, pp. 270-279.
- [5] Stander, N. Goel, T. Metamodel sensitivity to sequential sampling strategies in crashworthiness design. *Proceedings of the 12<sup>th</sup> AIAA/ISSMO Multidisciplinary Analysis and Optimization Conference, Victoria, British Columbia, Canada, Sep 10-12, 2008.*
- [6] Stander, N., Craig, K.J. On the robustness of a simple domain reduction scheme for simulation-based optimization, *Engineering Computations*, 19(4), pp. 431-450, 2002.

# Appendix A

## LS-DYNA D3Plot Result Components

The table contains component names for element variables. The result type and component name must be specified in the “*D3Plot*” interface commands to extract response variables.

Result Type	Number	Description	Component name
Stress	1	$xx, yy, zz, xy, yz, zx$ stress	xx_stress
	2		yy_stress
	3		zz_stress
	4		xy_stress
	5		yz_stress
	6		zx_stress
	7	Effective plastic strain	plastic_strain
	8	Pressure or average strain	pressure
	9	von Mises stress	von_mises
	10	First principal deviator maximum	1st_prin_dev_stress
	11	Second principal deviator	2st_prin_dev_stress
	12	Third principal deviator minimum	3rd_prin_dev_stress
	13	Maximum shear stress	max_shear_stress
	14	1st principal maximum stress	1st_principal_stress
	15	2nd principal stress	2st_principal_stress
	16	3rd principal min	3st_principal_stress
Ndv	17	x-displacement	x_displacement
	18	y-displacement	y_displacement
	19	z-displacement	z_displacement
	20	Displacement magnitude	result_displacement
	21	x-velocity	x_velocity
	22	y-velocity	y_velocity
	23	z-velocity	z_velocity
	24	Velocity magnitude	result_velocity
	64	xy-displacement	xy_displacement
	65	yz-displacement	yz_displacement
66	zx-displacement	zx_displacement	
Result	26	$M_{xx}$ bending resultant	Mxx_bending
	27	$M_{yy}$ bending resultant	Myy_bending
	28	$M_{xy}$ bending resultant	Mxy_bending
	29	$Q_{xx}$ shear resultant	Qxx_shear
	30	$Q_{yy}$ shear resultant	Qyy_shear
	31	$N_{xx}$ normal resultant	Nxx_normal
	32	$N_{yy}$ normal resultant	Nyy_normal
	33	$N_{xy}$ normal resultant	Nxy_normal
	34	Surface stress $N_{xx}/t + 6M_{xx}/t^2$	Nxx/t+6Mxx/t^2
	35	Surface stress $N_{xx}/t - 6M_{xx}/t^2$	Nxx/t-6Mxx/t^2
	36	Surface stress $N_{yy}/t - 6M_{yy}/t^2$	Nyy/t-6Myy/t^2
37	Surface stress $N_{yy}/t + 6M_{yy}/t^2$	Nyy/t+6Myy/t^2	

Result Type	Number	Description	Component name	
	38	Surface stress $N_{xy}/t - 6M_{xy}/t^2$	Nxy/t+6Mxy/t^2	
	39	Surface stress $N_{xy}/t + 6M_{xy}/t^2$	Nxy/t+6Mxy/t^2	
	40	Effective upper surface stress	u_surf_eff_stress	
	41	Effective lower surface stress	l_surf_eff_stress	
Strain	43	Lower surface effective plastic strain	l_surf_plastic_strain	
	44	Upper surface effective plastic strain	u_surf_plastic_strain	
	45	Lower surface xx, yy, zz, xy, yz, zx strain	l_surf_xx_strain	
	46		l_surf_yy_strain	
	47		l_surf_zz_strain	
	48		l_surf_xy_strain	
	49		l_surf_yz_strain	
	50		l_surf_zx_strain	
	51		Upper surface xx, yy, zz, xy, yz, zx strain	u_surf_xx_strain
	52			u_surf_yy_strain
	53	u_surf_zz_strain		
	45	u_surf_xy_strain		
	55	u_surf_yz_strain		
	56	u_surf_zx_strain		
	57	Middle surface xx, yy, zz, xy, yz, zx strain		m_surf_xx_strain
	58			m_surf_yy_strain
	59		m_surf_zz_strain	
	60		m_surf_xy_strain	
	61		m_surf_yz_strain	
	62		m_surf_zx_strain	
69	Lower, upper, middle principal + effective strains		l_surf_max_princ_strain	
70			l_surf_2nd_princ_strain	
71		l_surf_min_princ_strain		
72		l_surf_effective_princ_strain		
73		u_surf_max_princ_strain		
74		u_surf_2nd_princ_strain		
75		u_surf_min_princ_strain		
76		u_surf_effective_princ_strain		
77		m_surf_max_princ_strain		
78		m_surf_2nd_princ_strain		
79		m_surf_min_princ_strain		
80		m_surf_effective_princ_strain		
Misc	25	Temperature	temperature	
	63	Internal energy density	internal energy	
	67	Shell thickness	shell_thickness	
	68	Shell thickness reduction (%)	%_thickness_reduction	
	81	History variable 1	history_var#1	
FLD	501	Lower, upper, middle, maxima surface eps1/fldc	lower_eps1/fldc	
	502		upper_eps1/fldc	
	503		middle_eps1/fldc	
	504		maxima_eps1/fldc	
	505	Lower, upper, middle, maxima surface fldc-eps1	lower_fldc-eps1	
	506		upper_fldc-eps1	
	507		middle_fldc-eps1	
	508		maxima_fldc-eps1	
	509	Lower, upper, middle, maxima surface eps1	lower_eps1	
	510		upper_eps1	
	511		middle_eps1	
	512		maxima_eps1	
	513	Lower, upper, middle, maxima surface eps2	lower_eps1	
	514		upper_eps1	



---

<b>Result Type</b>	<b>Number</b>	<b>Description</b>	<b>Component name</b>
	515		middle_eps1
	516		maxima_eps1
Beam	701	Axial Force	axial_force
	702	S Force	s_force
	703	T Force	t_force
	704	SS Moment	ss_moment
	705	TT Moment	tt_moment
	706	Torsion	torsion
	707	Axial_stress	axial_stress
	708	RS Shear Stress	rs_shear_stress
	709	TR Shear Stress	tr_shear_stress
	710	Plastic Strain	plastic_strain
	711	Axial strain	axial_strain

---

# Appendix B

## LS-DYNA Binout Result Components

### Airbag Statistics: ABSTAT

Component	Description
Volume	Volume
pressure	Pressure
internal_energy	Internal energy
dm_dt_in	Input mass flow rate
dm_dt_out	Output mass flow rate
total_mass	Mass
gas_temp	Temperature
density	Density
surface_area	Area
reaction	Reaction

### Boundary Nodal Forces: BNDOUT

Component	Description
<i>Subdirectory discrete/nodes</i>	
x_force	X-force
y_force	Y-force
z_force	Z-force
x_total	Total X-force
y_total	Total Y-force
z_total	Total Z-force
energy	Energy
etotal	Total Energy

### Discrete Element Forces: DEFORC

Component	Description
x_force	X-force
y_force	Y-force
z_force	Z-force
resultant_force	Resultant force
displacement	Change in length

### Element Output: ELOUT

Component	Description
<i>Subdirectory solid</i>	
sig_xx	XX-stress
sig_xy	YY-stress
sig_yy	ZZ-stress
sig_yz	XY-stress
sig_zx	YZ-stress
sig_zz	ZX-stress
yield	Yield function
effsg	Effective stress
eps_xx	XX-strain
eps_xy	YY-strain
eps_yy	ZZ-strain
eps_yz	XY-strain
eps_zx	YZ-strain
eps_zz	ZX-strain
<i>Subdirectory beam</i>	
axial	Axial force resultant
shear_s	s-Shear resultant
shear_t	t-Shear resultant
moment_s	s-Moment resultant
moment_t	t-Moment resultant
torsion	Torsional resultant

**Element Output: ELOUT**

<b>Component</b>	<b>Description</b>
<i>Subdirectory shell</i>	
sig_xx	XX-stress
sig_yy	YY-stress
sig_zz	ZZ-stress
sig_xy	XY-stress
sig_yz	YZ-stress
sig_zx	ZX-stress
plastic_strain	Plastic strain
upper_eps_xx	XX-strain
lower_eps_xx	
upper_eps_yy	YY-strain
lower_eps_yy	
upper_eps_zz	ZZ-strain
lower_eps_zz	
upper_eps_xy	XY-strain
lower_eps_xy	
upper_eps_yz	YZ-strain
lower_eps_yz	
upper_eps_zx	ZX-strain
lower_eps_zx	
<i>Subdirectory thickshell</i>	
sig_xx	XX-stress
sig_yy	YY-stress
sig_zz	ZZ-stress
sig_xy	XY-stress
sig_yz	YZ-stress
sig_zx	ZX-stress
yield	Yield
upper_eps_xx	XX-strain
lower_eps_xx	
upper_eps_yy	YY-strain
lower_eps_yy	
upper_eps_zz	ZZ-strain
lower_eps_zz	
upper_eps_xy	XY-strain
lower_eps_xy	
upper_eps_yz	YZ-strain
lower_eps_yz	
upper_eps_zx	ZX-strain
lower_eps_zx	

**Contact Entities Resultants: GCEOUT**

<b>Component</b>	<b>Description</b>
x_force	X-force
y_force	Y-force
z_force	Z-force
force_magnitude	Force magnitude
x_moment	X-moment
y_moment	Y-moment
z_moment	Z-moment
moment_magnitude	Moment magnitude

**Global Statistics: GLSTAT**

<b>Component</b>	<b>Description</b>
kinetic_energy	Kinetic energy
internal_energy	Internal energy
total_energy	Total energy
energy_ratio	Ratio
stonewall_energy	Stonewall energy
spring_and_damper_energy	Spring & Damper energy
hourglass_energy	Hourglass energy
sliding_interface_energy	Sliding interface energy
external_work	External work
global_x_velocity	Global x-velocity
global_y_velocity	Global y-velocity
global_z_velocity	Global z-velocity
system_damping_energy	System damping energy
energy_ratio_wo_eroded	Energy ratio w/o eroded
eroded_internal_energy	Eroded internal energy
eroded_kinetic_energy	Eroded kinetic energy

**Joint Element Forces: JNTFORC**

Component	Description
<i>Subdirectory joints</i>	
x_force	X-force
y_force	Y-force
z_force	Z-force
x_moment	X-moment
y_moment	Y-moment
z_moment	Z-moment
resultant_force	R-force
resultant_moment	R-moment
<i>Subdirectory type0</i>	
d(phi)_dt	d(phi)/dt
d(psi)_dt	d(psi)/dt (degrees)
d(theta)_dt	d(theta)/dt (degrees)
joint_energy	joint energy
phi_degrees	phi (degrees)
phi_moment_damping	phi moment-damping
phi_moment_stiffness	phi moment-stiffness
phi_moment_total	phi moment-total
psi_degrees	psi (degrees)
psi_moment_damping	psi-moment-damping
psi_moment_stiffness	psi-moment-stiffness
psi_moment_total	psi-moment-total
theta_degrees	theta (degrees)
theta_moment_damping	theta-moment-damping
theta_moment_stiffness	theta-moment-stiffness
theta_moment_total	theta-moment-total

**Material Summary: MATSUM**

Component	Description
kinetic_energy	Kinetic energy
internal_energy	Internal energy
x_momentum	X-momentum
y_momentum	Y-momentum
z_momentum	Z-momentum
x_rbvelocity	X-rigid body velocity
y_rbvelocity	Y-rigid body velocity
z_rbvelocity	Z-rigid body velocity
hourglass_energy	Hourglass energy

**Contact Node Forces: NCFORC**

Component	Description
<i>Subdirectory master_00001 and slave_00001</i>	
x_force	X-force
y_force	Y-force
z_force	Z-force
pressure	Pressure
x	X coordinate
y	Y coordinate
z	Z coordinate

**Nodal Point Response: NODOUT**

Component	Description
<i>Translational components</i>	
x_displacement	X-displacement
y_displacement	Y-displacement
z_displacement	Z-displacement
x_velocity	X-velocity
y_velocity	Y-velocity
z_velocity	Z-velocity
x_acceleration	X-acceleration
y_acceleration	Y-acceleration
z_acceleration	Z-acceleration
x_coordinate	X-coordinate
y_coordinate	Y-coordinate
z_coordinate	Z-coordinate
<i>Rotational components</i>	
rx_acceleration	XX-rotation
rx_displacement	YY-rotation
rx_velocity	ZZ-rotation
ry_acceleration	XX-rotational velocity
ry_displacement	YY-rotational velocity
ry_velocity	ZZ-rotational velocity
rz_acceleration	XX-rotational acceleration
rz_displacement	YY-rotational acceleration
rz_velocity	ZZ-rotational acceleration
<i>Injury coefficients</i>	
CSI	Chest Severity Index
HIC15	Head Injury Coefficient (15 ms)
HIC36	Head Injury Coefficient (36 ms)

**Nodal Forces: NODFOR**

Component	Description
x_force	X-force
y_force	Y-force
z_force	Z-force
x_total	X-total force
y_total	Y-total force
z_total	Z-total force
energy	Energy
etotal	Total Energy

**Rigid Body Data: RBDOUT**

Component	Description
<i>Translational components</i>	
global_dx	X-displacement
global_dy	Y-displacement
global_dz	Z-displacement
global_vx	X-velocity
global_vy	Y-velocity
global_vz	Z-velocity
global_ax	X-acceleration
global_ay	Y-acceleration
global_az	Z-acceleration
global_x	X-coordinate
global_y	Y-coordinate
global_z	Z-coordinate
local_dx	Local X-displacement
local_dy	Local Y-displacement
local_dz	Local Z-displacement
local_vx	Local X-velocity
local_vy	Local Y-velocity
local_vz	Local Z-velocity
local_ax	Local X-acceleration
local_ay	Local Y-acceleration
local_az	Local Z-acceleration

Component	Description
<i>Rotational components</i>	
global_rax	X-rotation
global_ray	Y-rotation
global_raz	Z-rotation
global_rdx	X-velocity
global_rdy	Y-velocity
global_rdz	Z-velocity
global_rvx	X-acceleration
global_rvy	Y-acceleration
global_rvz	Z-acceleration
local_rdx	Local X-rotation
local_rdy	Local Y-rotation
local_rdz	Local Z-rotation
local_rvx	Local X-velocity
local_rvy	Local Y-velocity
local_rvz	Local Z-velocity
local_rax	Local X-acceleration
local_ray	Local Y-acceleration
local_raz	Local Z-acceleration
<i>Direction cosines</i>	
dircos_11	11 direction cosine
dircos_12	12 direction cosine
dircos_13	13 direction cosine
dircos_21	21 direction cosine
dircos_22	22 direction cosine
dircos_23	23 direction cosine
dircos_31	31 direction cosine
dircos_32	32 direction cosine
dircos_33	33 direction cosine
<i>Injury coefficients</i>	
CSI	Chest Severity Index
HIC15	Head Injury Coefficient (15 ms)
HIC36	Head Injury Coefficient (36 ms)

**Reaction Forces: RCFORC**

Component	Description
x_force	X-force
y_force	Y-force
z_force	Z-force
mass	Mass

**RigidWall Forces: RWFORC**

<b>Component</b>	<b>Description</b>
<i>Subdirectory forces</i>	
normal_force	normal
x_force	X-force
y_force	Y-force
z_force	Z-force

**Section Forces: SECFORC**

<b>Component</b>	<b>Description</b>
x_force	X-force
y_force	Y-force
z_force	Z-force
x_moment	X-moment
y_moment	Y-moment
z_moment	Z-moment
x_centroid	X-center
y_centroid	Y-center
z_centroid	Z-center
total_force	Resultant force
total_moment	Resultant moment
area	Area

**Single Point Constraint Reaction Forces: SPCFORC**

<b>Component</b>	<b>Description</b>
x_force	X-force
y_force	Y-force
z_force	Z-force
x_resultant	Total X-force
y_resultant	Total Y-force
z_resultant	Total Z-force
x_moment	X-moment
y_moment	Y-moment
z_moment	Z-moment

**Spotweld and Rivet Forces: SWFORC**

<b>Component</b>	<b>Description</b>
axial	Axial force
shear	Shear force
failure_flag	Failure flag

# Appendix C

## Database files

### C.1 Design flow

Source Database file	Process	Output Database file	Level of directory for output database
Command file ( <b>com</b> )	Point selection	<b>Experiments_n.csv</b>	Solver
<b>Experiments_n.csv</b>	Simulation runs	Solver output files	Run
Solver output files	Result extraction	<b>AnalysisResults_n.csv</b> <b>ExtendedResults</b>	Solver
<b>AnalysisResults</b>	Approximation	<b>DesignFunctions</b> <b>Net</b>	Solver
<b>DesignFunctions</b> <b>VirtualHistories</b>	Optimize	<b>OptimumResults</b> <b>OptimizationHistory</b> <b>OptimizerHistory_n.csv</b> <b>lsopt_results_n.csv</b>	Work

### C.2 Database file formats

The database consists of text files, text files with comma separated values (.csv format) and binary files. The .csv files have three header lines. The first designates the version name, the second represents the variable names and the third represents the variable types. Variables names are provided for clarity (e.g. the user can import the file into a spreadsheet program) and to verify the consistency between the command file and the run database. The variable types are explained in Table 5. The symbol *sk* is used to ignore certain columns, e.g. the first one which simply contains the point number.

*Table 5: Variable types*

Symbol	Explanation
<i>dv</i>	Design variable
<i>nv</i>	Noise variable
<i>dc</i>	Discrete variable
<i>rs</i>	Response
<i>sk</i>	Ignore

### The *Experiments\_n.csv* file

This file appears in the case directory and is used to save the experimental point coordinates for the analysis runs. The file consists of header lines and data lines repeated for each experimental point.

```
lsopt_version 4.1
"Point", "tbumper", "thood",
"sk", "dv", "dv",
1,3.0000000000000000e+00,1.0000000000000000e+00,
2,5.0000000000000000e+00,1.0000000000000000e+00,
3,1.0000000000000000e+00,1.0000000000000000e+00,
4,1.0000000000000000e+00,5.0000000000000000e+00,
5,5.0000000000000000e+00,5.0000000000000000e+00,
```

### The *AnalysisResults\_n.csv* file

This file is used to save the responses at the experimental design points and appears in the case directory. Every line describes an experimental point and gives the variable and response values at the experimental point. The file consists of two header as well as data lines repeated for each experimental point.

```
lsopt_version 4.1
"Point", "tbumper", "thood", "Disp2", "Disp1"
"sk", "dv", "dv", "rs", "rs"
1,3.0000000000000000e+00,1.0000000000000000e+00,-7.3670259999999996e+02,-
1.6103350000000000e+02
2,5.0000000000000000e+00,1.0000000000000000e+00,-7.3311230000000000e+02,-
1.5946590000000000e+02
3,1.0000000000000000e+00,1.0000000000000000e+00,-7.4418650000000002e+02,-
1.6168279999999999e+02
4,1.0000000000000000e+00,5.0000000000000000e+00,-6.4731250000000000e+02,-
1.5394180000000000e+02
5,5.0000000000000000e+00,5.0000000000000000e+00,-6.1158939999999996e+02,-
1.6078149999999999e+02
```

Values of  $2.0 \times 10^{30}$  are assigned to responses of simulations with error terminations. The *AnalysisResults* file is synchronous with the *Experiments* file.

### The *DesignFunctions* file

The *DesignFunctions* file, which appears in the solver directory, is used to save a description of the polynomial design functions. It is an XML file with XML tags chosen such that the file is easy to read. Open a *DesignFunction.\** file in a text editor to understand the content of the database.

The order of the constants in the database is for polynomial design functions is:

```
beta_0, beta_1, ... , beta_n, beta_1_1, beta_1_2, beta_1_3, ..., beta_1_n,
      beta_2_2, beta_2_3, ....., beta_2_n,
      ....., beta_i_n,
      beta_n_n
```

with

$$f(x) = \text{beta}_0 + \text{beta}_1 \cdot x_1 + \dots + \text{beta}_n \cdot x_n + \\ \text{beta}_{1_1} \cdot x_1 \cdot x_1 + \text{beta}_{1_2} \cdot x_1 \cdot x_2 + \dots + \text{beta}_{1_n} \cdot x_1 \cdot x_n$$



$$\begin{aligned}
 &+ \text{beta}_{2\_2} * x_2 * x_2 + \dots + \text{beta}_{2\_n} * x_2 * x_n \\
 &\dots \\
 &+ \text{beta}_{n\_n} * x_n * x_n
 \end{aligned}$$

The following enumerations are used in the database.

Function Types	
NO_SURFACE	0
LINEAR	77
MULT	78
QUADRATIC	79
INTERACTION	80
ELLIPTIC	81
SPHERICAL	82
FEEDFORWARD	83
FF_COMMITTEE	84
RADIALBASIS	85
NEURALNETWORK	86
ANALYTICAL_DSA_SURFACE	87
NUMERICAL_DSA_SURFACE	88
KRIGING	89

Response Interface Type		
RESP_INTERF_NULL	0	Interface unknown
USERINTERFACE	700	User defined
BINARY	701	LS-DYNA d3plot
ASCII	702	LS-DYNA ascii files
REXPRESSION	703	Mathematical expression
XYFILE	704	User specified history file [t,f(t)]
LSDA_BINARY	705	
FREQUENCY	706	Frequency, Mode #, Generalized Mass
MASSC	707	Mass from d3hsp
D3P_DISP	708	Disp from d3 plot file

The flags for active coefficients exclude the constant  $a_0$ .

### The *VirtualHistoryFunction* file

The *VirtualHistoryFunction* file appears in the main *work* directory and stores the approximation models for all histories at each sampled time-step. One file per iteration is generated. Like the *DesignFunctions* file, this is also a XML database with XML tags chosen such that the file is easy to read. This file stores the approximation type, number of fitting points, bounds and number of design variables, approximation model information (C or Wt), fitting and PRESS residuals (R and PR) at the fitting points, and global error measures at each time-step (t) of the history curves. The enumerations for the type of the fitting function are the same as used for the *DesignFunctions*.

### The *OptimizationHistory* file

This file is used to save the optimization history results and appears in the *work* directory. Each line contains the values at the optimum point of an iteration.

<b>Entities</b>	<b>Count</b>
Objective values	Number of objectives
Variables	Number of variables
Variable lower bounds	Number of variables
Variable upper bounds	Number of variables
RMS errors	Number of responses
Average errors	Number of responses
Maximum errors	Number of responses
$R^2$ errors	Number of responses
Adjusted $R^2$ errors	Number of responses
PRESS errors	Number of responses
Prediction $R^2$	Number of responses
Maximum prediction error	Number of responses
Responses	Number of responses
Multi-objective	1
Constraint values	Number of constraints
Composite values	Number of composites
Responses (computed)	Number of responses
Max. constraint violation	1
Composites (computed)	Number of composites
Constraints (computed)	Number of constraints
Objectives (computed)	Number of objectives
Multi-objective (computed)	1
Max. constraint violation (computed)	1
Constants	Number of constants
Dependents	Number of dependents
RBDO lower bound probability*	Number of constraints
RBDO upper bound probability*	Number of constraints
Generation number <sup>#</sup>	1
Individual number <sup>#</sup>	1
*Only written for RBDO problems.	

<sup>#</sup>Only written for Direct GA simulations.

Values of  $2.0 \times 10^{-30}$  are assigned to responses of error terminations.

### The *ExtendedResults* file

This file contains all points represented in the *AnalysisResults\_n.csv* file and appears in the solver directory. All values are based on the simulation results. A line has the following format:

<b>Entities</b>	<b>Count</b>
Objective weights	Number of objectives
Objective values	Number of objectives
Variables	Number of solver variables
Responses	Number of solver responses
Multi-objective	1
Constraint values	Number of constraints
Composite values	Number of composites
Max. constraint violation	1
Constants	Number of constants
Dependents	Number of dependents

The values represent the number of entities in the solver. Values of  $2.0 \times 10^{30}$  are assigned to responses of simulations with error terminations.

### **The *OptimumResults* file**

This file contains just the optimum design point data and appears in the main work directory. All values are metamodel values, i.e. interpolated.

<b>Entities</b>	<b>Count</b>
Objective weights	Number of objectives
Objective values	Number of objectives
Variables	Number of variables
Responses	Number of responses
Multi-objective	1 or 0 (no objectives)
Constraint values	Number of constraints
Composite values	Number of composites
Max. constraint violation	1
Constants	Number of constants
Dependents	Number of dependents

### **The *Sobol\_GSA* file**

This file contains the global sensitivity analysis database *Sobol\_GSA.n* file and appears in the main *work* directory. One file per iteration is generated. For each response, the partial variance, main sensitivity index, total variance, and total Sobol sensitivity index due to different variables are stored. The mean and variance of the response is also stored. All quantities are based on metamodels. The analytical models are used to compute global sensitivity indices for polynomial approximations and Gaussian RBF functions, where as Monte-Carlo simulations are used for all other metamodels.

### **The *lsopt\_results* file**

This *lsda* binary database contains all the Tradeoff points. A database file *lsopt\_results\_[n].binout* is created in the main *work* directory for  $n^{th}$  iteration. This binary database file replaces the *TradeOff\** files created in the previous versions. The database lists the following information for each TradeOff point.

<b>Entities</b>	<b>Location</b>	<b>Count</b>
Objective values	Inside directory	Number of objectives
Variables	Inside directory	Number of solver variables
Responses	Inside directory	Number of solver responses
Multi-objective		1
Constraint values	Inside directory	Number of constraints
Composite values	Inside directory	Number of composites
Max. constraint violation		1
Constants	Inside directory	Number of constants
Dependents	Inside directory	Number of dependents
Generation Index		1
Individual Index		1

#### **The *lsopt\_db* file**

The file should not be used or edited by the user. It is used to communicate the state of the databases between various LS-OPT components. The content of the file is subject to change.

# Appendix D

## Mathematical Expressions

Mathematical expressions are available for the following entities:

Dependent  
result  
matrix  
history  
response  
composite  
multiobjective

### *Syntax rules*

Mathematical expressions are placed in curly brackets in the command file or in double angular brackets (e.g. `<<Thickness*25.4>>`) in the input template files.

Expressions consist of parameters and constants. A parameter can be any previously defined entity.

Expressions can be wrapped to appear on multiple lines.

Mathematical expressions can be used for any floating-point number, e.g. upper bound of constraint, convergence tolerance, objective weight, etc.

An expression is limited to 1024 characters.

Empty or underscore ( `_` ) arguments in functions will generate default values.

### *Intrinsic functions*

*Note:* Trigonometric functions use and return degrees, not radians.

int (a)	integer
nint (a)	nearest integer
abs (a)	absolute value
mod (a, b)	remainder of $a/b$
sign (a, b)	transfer of sign from $b$ to $ a $
max (a, b)	maximum of $a$ and $b$
min (a, b)	minimum of $a$ and $b$
sqrt (a)	square root
exp (a)	$e^a$
pow (a, b)	$a^b$
log (a)	natural logarithm
log10 (a)	base 10 logarithm
sin (a)	sine
cos (a)	cosine
tan (a)	tangent
asin (a)	arc sine
acos (a)	arc cosine
atan (a)	arc tangent
atan2 (a, b)	arc tangent of $a/b$
sinh (a)	hyperbolic sine
cosh (a)	hyperbolic cosine
tanh (a)	hyperbolic tangent
asinh (a)	arc hyperbolic sine
acosh (a)	arc hyperbolic cosine
atanh (a)	arc hyperbolic tangent
sec (a)	Secant
csc (a)	cosecant
ctn (a)	cotangent
cnd (a)	cumulative normal distribution: $\Phi_{0,1}(x) = \frac{1}{\sqrt{2\pi}} \int_{-\infty}^x \exp\left(-\frac{u^2}{2}\right) du$

Matrix functions (3×3 only):

inv (A)	Inverse of matrix $A$
tr (A)	Transpose of matrix $A$
rx (angle)	Rotation about $x$ -axis (angle in rad)
ry (angle)	Rotation about $y$ -axis (angle in rad)
rz (angle)	Rotation about $z$ -axis (angle in rad)

### Special functions

Special response functions can be specified to apply to response histories. These include integration, minima and maxima and finding the time at a specific value of the function. General expressions (in double quotes) can be used for limits and for the integration variable. Histories must be defined as strings in double quotes and functions of time using the symbol  $t$ , e.g. "Velocity( $t$ )".

Expression	Symbols
FilterHistory( <i>history</i> [, <i>filtertype</i> , <i>frequency</i> , <i>timeunits</i> , <i>num_average</i> ])	Filtered curve using SAE, Butterworth or running average
DerivativeHistory( <i>history</i> , <i>order</i> )	$\frac{df}{dt} \approx \frac{f_{i-2} - 8f_{i-1} + 8f_{i+1} - f_{i+2}}{12h}$
Crossplot ( <i>history_z</i> , <i>history_F</i> [, <i>numpoints</i> , <i>begin time</i> , <i>end time</i> ])	$F(z)$ given $F(t)$ and $z(t)$
Integral ( <i>expression</i> [, <i>t_lower</i> , <i>t_upper</i> , <i>variable</i> ])	$\int_a^b f(t)dg(t)$
Derivative ( <i>expression</i> [, <i>T_constant</i> ])	$\Delta f / \Delta t _{t=T} \sim df/dt _{t=T}$
Min ( <i>expression</i> [, <i>t_lower</i> , <i>t_upper</i> ])	$f_{\min} = \min_t[f(t)]$
Max ( <i>expression</i> [, <i>t_lower</i> , <i>t_upper</i> ])	$f_{\max} = \max_t[f(t)]$
Initial ( <i>expression</i> )	First function value on record
Final ( <i>expression</i> )	Last function value on record
TerminationTime ( <i>expression</i> )	Termination time. Time of last history value.
Lookup ( <i>expression</i> , <i>value</i> [, <i>t_lower</i> , <i>t_upper</i> ])	Inverse function $t(f=F)$
LookupMin ( <i>expression</i> [, <i>t_lower</i> , <i>t_upper</i> ])	Inverse function $t(f=f_{\min})$
LookupMax ( <i>expression</i> [, <i>t_lower</i> , <i>t_upper</i> ])	Inverse function $t(f=f_{\max})$
MeanSqErr ( <i>target_curve</i> , <i>computed_curve</i> [, <i>num_reg_points</i> , <i>start_point</i> , <i>end_point</i> , <i>weight_type</i> , <i>scale_type</i> , <i>weight_value</i> , <i>scale_value</i> , <i>weight_curve_name</i> , <i>scale_curve_name</i> ])	Mean Squared Error function $\frac{1}{P} \sum_{p=1}^P W_p \left( \frac{f_p(\mathbf{x}) - G_p}{s_p} \right)^2$
CurveMapSegment3 ( <i>target_curve</i> , <i>computed_curve</i> )	Curve Mapping discrepancy
Rotate ( <i>x1</i> , <i>y1</i> , <i>z1</i> , <i>x2</i> , <i>y2</i> , <i>z2</i> , <i>x3</i> , <i>y3</i> , <i>z3</i> )	Rotation matrix defined by 3 points. See Section 14.
Matrix3x3Init ( <i>x1</i> , <i>y1</i> , <i>z1</i> , <i>x2</i> , <i>y2</i> , <i>z2</i> , <i>x3</i> , <i>y3</i> , <i>z3</i> )	Initialize 3x3 matrix

The arguments used in the expressions have the following explanations:

Argument	Explanation	Symbol	Type
<i>t_lower</i>	lower limit of integration or range	$a$	generic
<i>t_upper</i>	upper limit of integration or range	$b$	generic
<i>variable</i>	integration variable	$g(t)$	generic
<i>expression</i>	history defined as an expression string	$f(t)$	generic
<i>value</i>	value for which lookup is required	$F$	generic

<i>T_constant</i>	specific time	<i>T</i>	generic
<i>target_curve,computed_curve</i>	Target, computed curve names	<i>G</i>	history
<i>Num_reg_points</i>	Number of regression points	<i>n</i>	integer
<i>Start_point,end_point</i>	Location of first/last regression points	<i>z<sub>0</sub>,z<sub>P</sub></i>	float
<i>Weight_type,Scale_type</i>	Weight and scale types		reserved
<i>Weight_value,scale_value</i>	Uniform weight and scale values	<i>W,s</i>	float
<i>History_z,history_F</i>	History names for abscissa and ordinate	<i>z(t),F(t)</i>	history
<i>numpoints</i>	Number of points in curve	-	integer
<i>Begin_time,end_time</i>	Begin and end times	<i>t<sub>i</sub>,t<sub>P</sub></i>	float
<i>x1,y1,z1,x2,y2,z2,x3,y3,z3</i>	Matrix components	-	generic
<i>filter_type</i>	Filtering type (SAE, Butterworth, running average)	-	integer
<i>frequency</i>	Filtering frequency (Hz)	<i>f</i>	float
<i>timeunits</i>	Time units (s or ms)	-	integer
<i>num_average</i>	Number of points averaged	-	integer
<i>order</i>	Order of differentiation (3 or 5 point template)	-	integer

“Generic” implies that the quantity can be an expression, another defined entity or a constant number. An entity (which may be specified in an expression) can be any defined LS-OPT entity. Thus `constant`, `variable`, `dependent`, `history`, `response` and `composite` are acceptable. An expression is given in double quotes, e.g., “4.2 \* C1\_1 \* Displacement(t)”.

#### Reserved variable names

Name	Explanation
<code>t</code>	Time
<code>LowerLimit</code>	0.0
<code>UpperLimit</code>	Maximum event time over all histories of all solvers

Omitting the lower and upper bounds implies operation over the entire available history.

The `Lookup` function allows finding the value of  $t$  for a specified value of  $f(t) = F$ . If such a value cannot be found, the largest value (within the specified bounds) of  $t$  in the history is returned. The `LookupMin` and `LookupMax` functions return the value of  $t$  at the minimum or maximum respectively.

The implied variable represented in the first column of any history file is  $t$ . Therefore all history files produced by the `DynaASCII` extraction command contain functions of  $t$ . The fourth argument of the `Integral` function defaults to  $t$ . The variable  $t$  must increase monotonically.

The derivative assumes a piecewise linear function defined by the points in the `history.n` file. `T_constant` in the `Derivative` function defaults to the end time.



If a time is specified smaller than the smallest time value of the computed history, the first value is returned (same as `Initial`). If a time is specified larger than the largest time value of the computed history, the last value is returned (same as `Final`). For derivatives the first or last slopes are returned respectively.

### *Constants associated with histories*

The following commands can be given to override defaults for history operations:

Constant	Explanation	Default
<code>variable fdstepsize</code>	Finite difference step size for numerical derivatives with respect to variables	$0.0001 * (\text{Upper bound} - \text{Lower bound})$
<code>historysize</code>	Number of time points for new history	10000

### **Command file syntax:**

---

```
variable fdstepsize value
historysize integer value
```

---

- The `variable fdstepsize` is used to find the gradients of expression composite functions. These are used in the optimization process.
- The `historysize` is used when new histories are generated.

### *Generic expressions*

Expressions can be specified for any floating-point number. In some cases, previously defined parameters can be used as follows:

Number type	Parameter type
Constant	none
Starting variable	constant
Range	variable
Variable bounds	variable
Shift factor for response	variable
Scale factor for response	variable
Constraint bounds	variable
Objective weight	variable
Target value (composite)	variable
Scale factor (composite)	variable
Weight (composite)	variable
Parameters of SRSM	none
Parameters of LFOPC	none

The parameter type represents the highest entity in the hierarchy. Thus constants are included in the variable parameters.

In LS-OPT, expressions can be entered for variables, constants, dependents, histories, responses constraints and objectives.

*Example:*

```
constant 'Target1' {12756.333/1000.}
constant 'Target2' {966002/1000.}
variable 'Emod' 1e7
composite 'Residual' type targeted
composite 'Residual' response 'F1' {Target1} scale {Target1}
composite 'Residual' response 'F2' {Target2} scale {Target2}
objective 'Residual'
$
variable fdstepsize {1/500.}
time fdstepsize {1/300.}
history size 10000
```

*Examples illustrating syntax of expressions*

*Example 1:*

The following example shows a simple evaluation of variables and functions. The histories are specified in plot files his1 and his2. A third function his3 is constructed from the files by averaging.

File his1:

```
0 0.0
100 1000
200 500
300 500
```

File his2:

```
0 0.0
100 2000
200 2000
300 2000
```

**Input file:**

```
"Mathematical Expressions"
$
$ CONSTANTS
$
constants 3
constant 'lowerlimit' 0
constant 'upperlimit' .200
constant 'angle' 30
$
```

```

$ DESIGN VARIABLE DEFINITIONS
$
variables 2
Variable 'x1' 45
Lower bound variable 'x1' -10
Upper bound variable 'x1' 50
Variable 'x2' 45
Lower bound variable 'x2' -10
Upper bound variable 'x2' 50
$
$ DEPENDENT VARIABLES
$
dependents 2
dependent 'll' {lowerlimit * 1000}
dependent 'ul' {upperlimit * 1000}
$
.
.
.
$
$ HISTORIES
$
history 3
history 'his1' file ".././his1"
history 'his2' file ".././his2"
history 'his3' {(his1(t) + his2(t))/2}
$
$ RESPONSES
$
responses 42
response 'LOWER'      expression {LowerLimit}
response 'UPPER'      expression {UpperLimit}
response 'UL'         expression {ul}
response 'First'      expression {Initial("his1(t)")}
response 'Last'       expression {Final("his1(t)")}
response 'Last3'      expression {Final("(his1(t) + his2(t))/2")}
response 'Max1'       expression {Max("his1(t)")}
response 'Max2'       expression {Max("his1(t)", "ll * 1.0")}
response 'Maximum11'  expression {Max("his1(t)", "ll", ul)}
response 'Maximum32'  expression {Max("his3(t)", ll, ul)}
response 'Minimum32'  expression {Min("his3(t)", ll, ul)}
response 'Inverse11'  expression {Lookup("his1(t)", 75)}
response 'Inverse21'  expression {Lookup("his2(t)", 75)}
response 'Inverse31'  expression {Lookup("his3(t)", 75)}
response 'Inverse33'  expression {Lookup("(his1(t) + his2(t))/2", 75)}
response 'MaxI'       expression {max(Inverse11, Inverse21)}
response 'MinI'       expression {min(Inverse11, Inverse21)}
response 'hist'       expression {his3(Inverse31)}
response 'hist66'     expression {his3(66.1) + 0.1}
response 'nhist66'    expression {nint(hist66)}
response 'ihist66'    expression {int(hist66)}
response 'Integ11'    expression {Integral("his1(t)")}
response 'Integ14'    expression {Integral("his1(t)", ll, ul, "t")}
response 'Integ15'    expression {Integral("his1(t)", ll, UPPER, "t")}
response 'Integ22'    expression {Integral("his2(t)", ll, ul, "t")}
response 'Integ32'    expression {Integral("his3(t)", ll, ul, "t")}
response 'Integ33'    expression {Integral("(his1(t) + his2(t))/2", ll, ul, "t")}
response 'Integ34'    expression {Integral("his3(t)")}

```

```

response 'Integ35'    expression {Integral("his3(t)",ll)}
response 'Integ36'    expression {Integral("his3(t)",ll,ul)}
$
$ Cross-functional integrals
$
response 'Integ2'     expression {Integral("his1(t)",ll,ul,"his2(t)")}
response 'Integ3a'    expression {Integral("his1(t)",0,30,"his2(t)")}
response 'Integ3b'    expression {Integral("his1(t)",30,100,"his2(t)")}
response 'Integ4'     expression {Integ1 + Integ2}
response 'Integ5'     expression {Integral("sin(t) * his1(t) * his2(t)",ll,ul,"t")}
response 'Integ7'     expression {Integral("sin(t) * his1(t) * his2(t)")}
response 'Velocity1'  expression {Derivative("Displacement(t)",0.08)}
response 'Velocity2'  expression {Derivative("Displacement(t)")}
$
$ COMPOSITE FUNCTIONS
$
composites 1
composite 'Integ6' { (Integ3a/(4*Maximum11) + Integ2/2)**.5}
$
$ OBJECTIVE FUNCTIONS
$
objectives 1
objective 'Integ6'
$
$ CONSTRAINT FUNCTIONS
$
constraints 1
constraint 'Integ1'
$
iterate 0
STOP

```

*Example 2:*

```

constant 'v0' 15.65
$-----
$ Extractions
$-----
history 'engine_velocity'      "DynaASCII nodout X_VEL 73579 TIMESTEP 0.0 SAE 30"
history 'Apillar_velocity_1'   "DynaASCII nodout X_VEL 41195 TIMESTEP 0.0 SAE 30"
history 'Apillar_velocity_2'   "DynaASCII nodout X_VEL 17251 TIMESTEP 0.0 SAE 30"
history 'global_velocity'      "DynaASCII glstat X_VEL 0 TIMESTEP 0.0"
$-----
$ Mathematical Expressions for dependent histories
$-----
history 'Apillar_velocity_average' {(Apillar_velocity_1 +
                                     Apillar_velocity_2)/2}
$
$ Find the time when the engine velocity = 0
$
response 'time_to_engine_zero' expression {Lookup("engine_velocity(t)",0)}
$
$ Find the average velocity at time of engine velocity = 0
$
response 'vel_A_engine_zero' expression {Apillar_velocity_average
                                         (time_to_engine_zero)}
$
$ Integrate the average A-pillar velocity up to zero engine velocity
$ Divide by the time to get the average

```

```
$
response 'PULSE_1' expression {Integral
    ("Apillar_velocity_average(t)", 0, time_to_engine_zero)
    /time_to_engine_zero}
$
$ Find the time at which the global velocity is zero
$
response 'time_to_zero_velocity' expression {Lookup("global_velocity(t)",0)}
$
$ Find the average A-pillar velocity where global velocity is zero
$
response 'velocity_final' {Apillar_velocity_average(time_to_zero_velocity)}
response 'PULSE_2' expression {Integral
    ("Apillar_velocity_average(t)", time_to_engine_zero,
    time_to_zero_velocity )
    /(time_to_zero_velocity - time_to_engine_zero)}
```

---

# Appendix E

## Glossary

**ANOVA.** Analysis of variance. Used to perform variable screening by identifying insignificant variables. Variable regression coefficients are ranked based on their significance as obtained through a partial  $F$ -test. (See also *variable screening*).

**Bias error.** The total error – the difference between the exact and computed response - is composed of a random and a bias component. The bias component is a systematic deviation between the chosen model (approximation type) and the exact response of the structure (FEA analysis is usually considered to be the exact response). Also known as the *modeling error*. (See also *random error*).

**Binout.** The name of the binary output file generated by LS-DYNA (Version 970 onwards).

**Committee.** A set of Neural Networks of the same order constructed using the same set of results. The nets are usually slightly different because a different weight initiator is typically used for the regression procedure of each individual net.

**Composite function.** A function constructed by combining responses and design variables into a single value. Symbolized by  $\mathcal{F}$ .

**Concurrent simulation.** The running of simulation tasks in parallel without message passing between the tasks.

**Confidence interval.** The interval in which a parameter may occur with a specified level of confidence. Computed using Student's  $t$ -test. Typically applied to accompany the significance of a variable in the form of an error bar.

**Constraint.** An absolute limit on a response variable specified in terms of an upper or lower limit.

**Constrained optimization.** The mathematical optimization of a function subject to specified limits on other functions.

**Conventional Design.** The procedure of using experience and/or intuition and/or *ad hoc* rules to improve a design.

**Crossplot.** A curve obtained by using the two ordinate values at a coinciding abscissa obtained from two separate functions. The two ordinate values are used as the abscissa and ordinate in the new crossplot. In LS-OPT two separate time histories are typically used to construct a single crossplot.

**Delimiter.** Symbol(s) to separate numeric fields in a text file. Typically spaces, tabs or commas.

**Dependent.** A function which is dependent on variables. Dependent variable.

**Design of Experiments.** See experimental design.

**Design parameter.** See *design variable*.

**Design formula.** A simple mathematical expression which gives the response of a design when the design variables are substituted. See *response surface*.

**Design space.** A region in the  $n$ -dimensional space of the design variables ( $x_1$  through  $x_n$ ) to which the design is limited. The design space is specified by upper and lower bounds on the design variables. Response variables can also be used to bound the design space.

**Design surface.** The response variable as a function of the design variables, used to construct the formulation of a design problem. (See also *response surface*, *design rule*).

**Design sensitivity.** The gradient vector of the response. The derivatives of the response function in terms of the design variables.  $df/dx_i$ .

**Design variable.** An independent design parameter which is allowed to vary in order to change the design. Symbolized by ( $x_i$  or  $\mathbf{x}$  (vector containing several design variables)).

**Discipline.** An area of analysis requiring a specific set of simulation tools, usually because of the unique nature of the physics involved, e.g. structural dynamics or fluid dynamics. In the context of MDO, often used interchangeably with solver.

**DOE.** Design of Experiments. See experimental design.

**Domain reduction.** The reduction of the region of interest in the design space during the optimization process.

**$D$ -optimal.** The state of an experimental design in which the determinant of the moment matrix  $|\mathbf{X}^T \mathbf{X}|$  of the least squares formulation is maximized.

**DSA.** Design sensitivity analysis.

**Ensemble.** A collection of neural nets of different (usually thought of as ascending) order based on the same set of results.

**Elliptic approximation.** An approximation in which only the diagonal Hessian terms are used.

**Experiment.** Evaluation of a single design.

**Experimental Design.** The selection of designs to enable the construction of a design response surface. Sometimes referred to as the *Point Selection Scheme*.

**Feasible Design.** A design which complies with the constraint bounds.

**Feedforward Neural Network.** See *Neural Network*.

**Function.** A mathematical expression for a response variable in terms of design variables. Often used interchangeably with “response”. Symbolized by  $f$ .

**Functionally efficient.** See Pareto optimal.

**Function evaluation.** Using a solver to analyze a single design and produce a result. See *Simulation*.

**Global variable.** A variable of which the scope spans across all the design disciplines or solvers. Used in the MDO context.

**Global approximation.** A design function which is representative of the entire design space.

**Global Optimization.** The mathematical procedure for finding the global optimum in the design space. E.g. Genetic Algorithm, Particle Swarm, etc.

**Gradient vector.** A vector consisting of the derivatives of a function  $f$  in terms of a number of variables  $x_1$  to  $x_n$ .  $\mathbf{s} = [df/dx_i]$ . See *Design Sensitivity*.

**History.** Response history containing two columns of (usually time) data generated by a simulation.

**Importance.** See *Weight*.

**Infeasible Design.** A design which does not comply with the constraint functions. An entire design space or region of interest can sometimes be infeasible.

**Isoline.** A line representing a constant value of a scalar quantity. In the LS-OPT metamodel plotting feature isolines are used with metamodel functions.

**Iteration.** A cycle involving an experimental design, function evaluations of the designs, approximation and optimization of the approximate problem.

**Kriging.** A Metamodeling technique using Bayesian regression.

**Latin Hypercube Sampling.** The use of a constrained random experimental design as a point selection scheme for response approximation.



**Least Squares Approximation.** The determination of the coefficients in a mathematical expression so that it approximates certain experimental results by the minimization of the sum of the squares of the approximation errors. Used to determine response surfaces as well as calibrating analysis models.

**Local Approximation.** See *Gradient vector*.

**Local variable.** A variable of which the scope is limited to a particular discipline or disciplines. Used in the MDO context.

**Material identification.** See *parameter identification*.

**MDO.** Multidisciplinary design optimization.

**Metamodeling.** The construction of surrogate design models such as polynomial response surfaces, Artificial Neural Networks or Kriging surfaces from simulations at a set of design points.

**Min-Max optimization problem.** An optimization problem in which the maximum value considering several responses or functions is minimized.

**Model calibration.** The optimal adjustment of parameters in a numerical model to simulate the physical model as closely as possible.

**Modeling error.** See *bias error*.

**Multidisciplinary design optimization (MDO).** The inclusion of multiple disciplines in the design optimization process. In general, only some design variables need to be shared between the disciplines to provide limited coupling in the optimization of a multidisciplinary target or objective.

**Multi-objective.** An objective function which is constituted of more than one objective. Symbolized by F.

**Multi-objective Optimization (MOO).** Multi-objective optimization is the procedure for constructing a *Pareto optimal front*.

**Multi-criteria.** Refers to optimization problems in which several criteria are considered.

**MP.** Mathematical Programming. Mathematical optimization.

**MSE.** Mean Squared Error. Used for system identification.

**Neural network approximation.** The use of trained feedforward neural networks to perform non-linear regression, thereby constructing a non-linear metamodels (*see metamodeling*).

**Numerical sensitivity.** A derivative of a function computed by using finite differences.

**Noise.** See *random error*.

**Objective.** A function of the design variables that the designer wishes to minimize or maximize. If there exists more than one objective, the objectives have to be combined mathematically into a single objective. Symbolized by  $\Phi$ .

**Optimal design.** The methodology of using mathematical optimization tools to improve a design iteratively with the objective of finding the ‘best’ design in terms of predetermined criteria.

**Optimization strategy.** A strategy for metamodel-based optimization such as Single Stage, Sequential or Sequential with Domain Reduction.

**Parameter identification.** See System identification.

**Pareto optimal.** A multi-objective design is Pareto-optimal if none of the objectives can be improved without at least one objective being affected adversely. A Pareto optimal front can be constructed using optimization.

**Point selection scheme.** Same as experimental design.

**Preference function.** A function of objectives used to combine several objectives into a single one suitable for the standard MP formulation.

**Preprocessor.** A graphical tool used to prepare the input for a solver.

**Radial basis function network.** The use of radial basis functions (RBFs) to approximate response functions. The LS-OPT default option is the Hardy’s multi-quadrics but a user can also select Gaussian function as the radial basis function. This is a global approximation method.

**Random error.** The total error – the difference between the exact and computed response - is composed of a random and a bias component. The random component is, as the name implies, a random deviation from the nominal value of the exact response, often assumed to be normally distributed around the nominal value. (See also *bias error*).

**Reasonable design space.** A subregion of the design space within the region of interest. It is bounded by lower and upper bounds of the response values.

**Region of interest.** A sub-region of the design space. Usually defined by a mid-point design and a range of each design variable. Usually dynamic.

**Reliability-based design optimization (RBDO).** The performing of design optimization while considering reliability-based failure criteria in the constraints of the design optimization formulation. This implies the inclusion of random variables in the generation of responses and then extracting the standard deviation of the responses about their mean values due to the random variance and including the standard deviation in the constraint(s) calculation.

**Residual.** The difference between the computed response (using simulation) and the predicted response (using a response surface).

**Response quantity.** See *response*.

**Response Surface.** A mathematical expression which relates the response variables to the design parameters. Typically computed using statistical methods.

**Response.** A numerical indicator of the performance of the design. A function of the design variables approximated using a metamodel which can be used for optimization. Symbolized by  $f$ . Collected over all design iterations for plotting. (See also *history*).

**Result.** A numerical indicator of the performance of the design. A result is not associated with a metamodel, but is typically used for intermediate calculations in metamodel-based analysis.

**RBF.** Radial Basis Function. RBF's are used as basis functions for metamodels (see also *metamodeling*). These functions are typically Gaussian.

**RSM.** Response Surface Methodology.

**Run directory.** The directory in which the simulations are done. Two levels below the *Work directory*. The run directory contains status files, the design coordinate file `XPOINT` and all the simulation output. The `logxxxx` file which contains a log of the file transfer, the output log of the solver and a log of the result extraction also resides in this directory.

**Saturated design.** An experimental design in which the number of points equals the number of unknown coefficients of the approximation. For a saturated design no test can be made for the lack of fit.

**Scale factor.** A factor which is specified as a divisor of a response in order to normalize the response.

**Sensitivity.** See *Design sensitivity*.

**Slack constraint.** A constraint with a slack variable. The violation of this constraint can be minimized.

**Slack variable.** The variable which is minimized to find a feasible solution to an optimization problem, e.g.  $e$  in:  $\min e$  subject to  $g_j(x) \leq e$ ;  $e \geq 0$ . See *Strictness*.

**Simulation.** The analysis of a physical process or entity in order to compute useful responses. See *Function evaluation*.

**Solver.** A computational tool used to analyze a structure or fluid using a mathematical model. See *Discipline*.

**Solver directory.** A subdirectory of the work directory that bears the name of a solver and where database files resulting from extraction and the optimization process are stored.

**Space Filling Experimental Design.** A class of experimental designs that employ an algorithm to maximize the minimum distance between any two points.

**Space Mapping.** A technique which uses a fine design model to improve a coarse surrogate model. The hope is, that if the misalignment between the coarse and fine models is not too large, only a few fine model simulations will be required to significantly improve the coarse model. The coarse model can be a response surface.

**Stochastic.** Involving or containing random variables. Involving probability or chance.

**Stopping Criterion.** A mathematical criterion for terminating an iterative procedure.

**Strictness.** A number between 0 and 1 which signifies the strictness with which a design constraint must be treated. A zero value implies that the constraint *may* be violated. If a feasible design is possible all constraints will be satisfied. Used in the design formulation to minimize constraint violations. See *Slack variable*.

**Subproblem.** The approximate design subproblem constructed using response surfaces. It is solved to find an approximate optimum.

**Subregion.** See *region of interest*.

**Successive (or Sequential) Approximation Method.** An iterative method using the successive solution of approximate subproblems.

**System identification.** A procedure in which a numerical model is calibrated by optimizing selected parameters in order to minimize the residual error with respect to certain targeted responses. The targeted responses are usually derived from experimental results.

**Target.** A desired value for a response. The optimizer will not use this value as a rigid constraint. Instead, it will try to get as close as possible to the specified value.

**Template.** An input file in which some of the data has been replaced by variable names, e.g. <<Radius>>. A template may also contain the LS-DYNA \*PARAMETER keyword with corresponding @-parameters. LS-OPT will recognize the parameters defined in the template and display them in the GUI.

**Trade-off curve.** A curve constructed using *Pareto optimal* designs.

**Transformed variables.** Variables which are transformed (mapped) to a different  $n$ -space using a functional relationship. The experimental design and optimization are performed in this space.

**Variable screening.** Method to remove insignificant variables from the design optimization process based on a ranking of regression coefficients using analysis of variance (ANOVA). (See also *ANOVA*).

**Weight.** A measure of importance of a response function or objective. Typically varies between 0 and 1.

**Work directory.** The directory in which the input files reside and where output is produced. See also *Run directory*.

# Appendix F

## LS-OPT Commands: Quick Reference Manual

### Note:

All commands are case insensitive.

The commands which are definitions are given in boldface.

Page reference numbers of the syntax definition are given in the last column.

Command phrases in { } are optional.

Names cannot start with a number.

*string*: Extraction command, solver/preprocessor command, filename (pathname) in double quotes  
*name*: Name in single quotes  
*expression*: Mathematical expression in curly brackets

### F.1. Problem description

Constants <i>number</i>	The number of constants in the problem	153
Variables <i>number</i>	The number of variables in the problem	153
Dependents <i>number</i>	The number of dependent variables	153
Histories <i>number</i>	The number of histories	153
Responses <i>number</i>	The number of responses	153
Composites <i>number</i>	The number of composite functions	153
Objectives <i>number</i>	The number of objectives	153
Constraints <i>number</i>	The number of constraints	153
Solvers <i>number</i>	The number of solvers	153
Distribution <i>number</i>	The number of probabilistic distributions	153

### F.2. Parameter definition

<b>Constant</b> <i>name value</i>	constant	225
-----------------------------------	----------	-----

### F.3. Probabilistic distributions

Distribution name type values

228

<i>type</i>	<i>values</i>
NORMAL	mu sigma
UNIFORM	lower upper
USER_DEFINED_PDF	filename
USER_DEFINED_CDF	filename
LOGNORMAL	mu sigma
WEIBULL	scale shape
BETA	lower upper shape1 shape2

### F.4. Design space and region of interest

<b>Variable</b> name value	Starting value for design variable	223
Range name value	Range of variable to define region of interest	223
Lower bound variable name value	Lower bound of Variable	223
Upper bound variable name value	Upper bound of Variable	223
<b>Dependent</b> name expression	Dependent variable	225
Variable name max	Saddle direction flag	226
<b>Constant</b> name value	Value of constant	225
Local name	Variable is not global	224

### F.5. Multidisciplinary or multi-case environment

<b>Solver</b> package_name name	software package identifier	205
Solver input file string	solver input file name	205
Solver command string	solver command line	205
Solver append file string	name of file to be appended to input	205
Solver check file string	name of checkpoints file	265
Solver evaluate file string	name of sampling points file	265
Solver extra file string	names of extra files (can be repeated)	220
Solver concurrent jobs number	number of concurrent jobs	164
Solver variable	Flag for solver variable	225
Prepro name	software package identifier	211
Prepro command string	pre-processor command file	211
Prepro input file name	pre-processor input file	211
Prepro output file name	pre-processor output file name for Templex	214
Queue queue type	queue for workload scheduling	166
Interval value	time interval for progress reports	205

## F.6. Package identifiers

ingrid	LS-INGRID	212
truegrid	TrueGrid	212
ansa	ANSA	213
hypermorph	HyperMorph	215
dyna	LS-DYNA (versions prior to 960)	205
dyna960	LS-DYNA Version 960/970	205
own	user-defined	210

## F.7. Queuer identifiers

lsf	Load Sharing Facility
loadleveler	IBM LoadLeveler
pbs	PBS
nqe	NQE
nqs	NQS
aqs	AQS
slurm	SLURM
blackbox	Blackbox
mscpp	MS Windows Compute Cluster Server

## F.8. Metamodel

Solver order [linear elliptic interaction quadratic FF RBF user]	Type of approximating function	254
Solver RBF transfer [HMQ GAUSS]	Type of transfer function	247
Solver FF_committee size <i>number</i>	Size of a FFNN committee	247
Solver FF_committee discard <i>number</i>	Discard 2* <i>number</i> committee members	247
Solver FF_committee use [MEAN MEDIAN]	Centering procedure for NN evaluation	247
Solver user metamodel <i>name</i>	Name (without pre-/suffix)	251
Solver user metamodel path <i>path</i>	Metamodel library path	251
Solver user metamodel command <i>string</i>	String used by metamodel	251
Solver user metamodel param <i>value</i>	Input value	251

## F.9. Point selection

Solver experimental design <i>design</i>	Experimental design type	255
--	--------------------------	-----

Solver basis experiment <i>design</i>	Basis experiment for <i>D</i> -optimal design points selection scheme	255
Solver number basis experiments <i>number</i>	Number of experimental points	255
Solver number experiment <i>number</i>	Number of experimental points	255
Solver update <i>doe</i>	Updating of experimental points	263
Solver experiment duplicate <i>name</i>	Duplicate previously defined experiment	260
Solver alternate experiment 1	Alternative experimental design required for first iteration	266
Solver alternate order [ <i>linear</i> ]	Type of alternative approximating function	266
Solver alternate experimental design <i>design</i>	Alternative experimental design type	266
Solver alternate basis experiment <i>design</i>	Alternative basis experiment for <i>D</i> -optimal design points selection scheme	266
Solver alternate number basis experiments <i>number</i>	Alternative number of experimental points	266
Solver alternate number experiment <i>number</i>	Alternative number of experimental points	266
Solver experiment augment iteration <i>number</i>	Change number of points starting with iteration	267

## F.10. Point selection types

Experiment Description	Identifier	Default approximation
Linear Koshal	lin_koshal	linear
Quadratic Koshal	quad_koshal	quadratic
Central Composite	composite	quadratic
Latin Hypercube	latin_hypercube	linear
Monte Carlo	monte_carlo	linear
Plan	plan	linear
User-defined	user	linear
<i>D</i> -optimal	dopt	linear
Space filling	space_filling	-
Duplicate	duplicate	-
Factorial Designs		
$2^n$	2toK	Linear
$3^n$	3toK	quadratic
$\vdots$	$\vdots$	$\vdots$
$11^n$	11toK	quadratic

## F.11. Database recovery

Solver recover dyna [ <i>d3plot</i>   <i>d3hsp</i>   <i>binout</i>   <i>d3eigv</i> ]	Recover DYNA database files of a remote job for given prefix	182
Solver recover file <i>file_wildcard</i>	Recover database file(s) of a remote job	183



## F.12. Design problem formulation

<b>History name string</b>	Defines history function	270
<b>History name expression</b>	Defines history function	270
<b>History name file string</b>	History from file	270
<b>Historysize number</b>	Defines maximum number of data points in history function	273
<b>Result name string</b>	Defines a result	311
<b>Result name expression</b>	Defines a result	311
<b>Matrix name expression</b>	Defines a matrix	311
<b>Response name string</b>	Defines response function	276
<b>Response name expression</b>	Defines response function	276
<b>Response</b> [linear elliptic quadratic FF kriging]	Type of approximation	333
<b>Composite name type</b> [weighted targeted]	Type of composite function	332
<b>Composite name expression</b>	Defines composite function	333
<b>Composite name response name value* { scale factor }</b>	Component definition	333
<b>Composite name variable name value* { scale factor }</b>	Component definition	333
<b>Weight value</b>	Weight (only targeted)	334
<b>Maximize</b>	Maximize objective	341
<b>Objective name { weight }</b>	Objective definition	341
<b>Constraint name</b>	Constraint definition	342
[Lower upper] bound <b>constraint name value</b>	Bound on constraint	343
Strict / slack	Slack variable omission status	344
Move / stay / move start	Reasonable space sampling	262
<b>Constraint name scale</b> [lower upper] bound <b>factor</b>	Constraint scale factor	346

\* *value* = target value for type = MSE, weight for type = weighted

## F.13. LS-DYNA result interfaces

DynaMass <i>p1 p2 p3 ... pn mass_attribute</i>	Mass	285
DynaThick [THICKNESS REDUCTION] <i>p1 p2 ... pm</i> [MIN MAX AVE]	Shell thickness	287
DynaFLD <i>p1 p2 ... pn intercept neg_slope</i> <i>pos_slope</i>	FLD	289

DynaFLDg [LOWER CENTER UPPER] <i>p1 p2 ... pn</i> <i>load_curve_id</i>	General FLD	290
DynaPStress [S1 S2 S3 MEAN] <i>p1 p2 ... pn</i> [MIN MAX AVE]	Principal stress	291
DynaFreq <i>mode_original</i> [FREQ NUMBER GENMASS]	Modal data	<b>Error! Bookmark not defined.</b>
BinoutHistory -res_type <i>res_type</i> {-sub <i>sub</i> } -cmp component {-invariant <i>invariant</i> -id <i>id</i> -pos <i>position</i> -side <i>side</i> -filter <i>filter_type</i> - filter_freq <i>filter_freq</i> -units <i>units</i> -ave_points <i>ave_points</i> -start_time <i>start_time</i> - end_time <i>end_time</i> }	Binout	279
BinoutResponse { <i>history_options</i> } -select <i>MAX/MIN/AVE/TIME</i>	Binout	280
D3PlotHistory -res_type <i>res_type</i> {-sub <i>sub</i> } - cmp component {-id <i>id</i> -pos <i>position</i> -pids <i>part_ids</i> -loc <i>ELEMENT/NODE</i> -select <i>selection</i> - coord x y z -tref <i>ref_state</i> -setid <i>setid</i> }{- start_time <i>start_time</i> -end_time <i>end_time</i> }	d3plot	282
D3PlotResponse { <i>history_options</i> } -select <i>selection</i>	d3plot	284

## F.14. Solution tasks

Iterate <i>n</i>	Iterate over <i>n</i> successive approximations	348
Analyze Monte Carlo	Monte Carlo evaluation	239
Analyze Metamodel Monte Carlo	Monte Carlo evaluation with metamodel	240

## F.15. LS-DYNA Results Statistics

analyze dynastat { <i>history name</i> }	Compute LS-DYNA results statistics	423
dynastat order <i>approx_order</i>	Use metamodels; order of metamodel	420
dynastat outlier <i>ON/OFF</i>	Report metamodel outliers	420
dynastat max vector <i>ON/OFF</i>	Displacement magnitude formulation	435
dynastat component vector <i>ON/OFF</i>	Displacement magnitude formulation	435
dynastat correlation response <i>name</i>	Correlation	424
dynastat solver <i>name</i>	Solver	423
dynastat iteration <i>number</i>	Iteration	423

## F.16. Intrinsic functions for mathematical expressions

*Note:* Trigonometric functions use and return degrees, not radians.

int (a)	integer
nint (a)	nearest integer
abs (a)	absolute value
mod (a, b)	remainder of $a/b$
sign (a, b)	transfer of sign from $b$ to $ a $
max (a, b)	maximum of $a$ and $b$
min (a, b)	minimum of $a$ and $b$
sqrt (a)	square root
exp (a)	$e^a$
pow (a, b)	$a^b$
log (a)	natural logarithm
log10 (a)	base 10 logarithm
sin (a)	sine
cos (a)	cosine
tan (a)	tangent
asin (a)	arc sine
acos (a)	arc cosine
atan (a)	arc tangent
atan2 (a, b)	arc tangent of $a/b$
sinh (a)	hyperbolic sine
cosh (a)	hyperbolic cosine
tanh (a)	hyperbolic tangent
asinh (a)	arc hyperbolic sine
acosh (a)	arc hyperbolic cosine
atanh (a)	arc hyperbolic tangent
sec (a)	secant
csc (a)	cosecant
ctn (a)	Cotangent
cnd (a)	cumulative normal distribution: $\Phi_{0,1}(x) = \frac{1}{\sqrt{2\pi}} \int_{-\infty}^x \exp\left(-\frac{u^2}{2}\right) du$

3×3 Matrix functions:

inv (A)	Inverse of matrix $A$
tr (A)	Transpose of matrix $A$
rx (angle)	Rotation about $x$ -axis (angle in rad)
ry (angle)	Rotation about $y$ -axis (angle in rad)
rz (angle)	Rotation about $z$ -axis (angle in rad)

## F.17. Special functions for mathematical expressions

Expression	Symbols	Type
Crossplot( <i>expr_f</i> , <i>expr_g</i> [, <i>numpts</i> , <i>t_lower</i> , <i>t_upper</i> ])	Crossplot $g(t)$ vs. $f(t)$	Virtual History
DerivativeHistory( <i>history</i> , <i>order</i> )	$\frac{df}{dt} \approx \frac{f_{i+2} - 8f_{i+1} + 8f_i - f_{i-2}}{12h}$	History
FilterHistory( <i>history</i> [, <i>type</i> , <i>frequency</i> , <i>timeunits</i> , <i>num_average</i> ])	Filtered curve using SAE, Butterworth or running average	History
Integral( <i>expression</i> [, <i>t_lower</i> , <i>t_upper</i> , <i>variable</i> ])	$\int_a^b f(t) dg(t)$	Resp.
Derivative( <i>history</i> [, <i>T_constant</i> ])	$\frac{df}{dt} \approx \frac{f_{i+2} - 8f_{i+1} + 8f_i - f_{i-2}}{12h}$	Resp.
Min( <i>expression</i> [, <i>t_lower</i> , <i>t_upper</i> ])	$f_{\min} = \min_t [f(t)]$	Resp.
Max( <i>expression</i> [, <i>t_lower</i> , <i>t_upper</i> ])	$f_{\max} = \max_t [f(t)]$	Resp.
Initial( <i>expression</i> )	First function value on record	Resp.
TerminationTime ( <i>expression</i> )	Last time value	Resp.
Final( <i>expression</i> )	Last function value on record	Resp.
Lookup( <i>expression</i> , <i>value</i> [, <i>t_lower</i> , <i>t_upper</i> ])	Inverse function $t(f=F)$	Resp.
LookupMin( <i>expression</i> [, <i>t_lower</i> , <i>t_upper</i> ])	Inverse function $t(f=f_{\min})$	Resp.
LookupMax( <i>expression</i> [, <i>t_lower</i> , <i>t_upper</i> ])	Inverse function $t(f=f_{\max})$	Resp.
MeanSqErr( <i>target_G</i> , <i>history_f</i> [, <i>numpts</i> , <i>z_low</i> , <i>z_up</i> , <i>wgt_typ</i> , <i>scl_typ</i> , <i>wgt_val</i> , <i>scl_val</i> , <i>wgt_curve</i> , <i>scl_curve</i> ])	$\frac{1}{P} \sum_{p=1}^P W_p \left( \frac{f_p(\mathbf{x}) - G_p}{s_p} \right)^2$	Comp.
CurveMapSegment3( <i>target_G</i> , <i>history_f</i> )	See Section 5.3.2	Comp.
Matrix3x3Init( <i>x1</i> , <i>y1</i> , <i>z1</i> , <i>x2</i> , <i>y2</i> , <i>z2</i> , <i>x3</i> , <i>y3</i> , <i>z3</i> )	Initialize 3×3 matrix	Matrix
Rotate( <i>x1</i> , <i>y1</i> , <i>z1</i> , <i>x2</i> , <i>y2</i> , <i>z2</i> , <i>x3</i> , <i>y3</i> , <i>z3</i> )	Rotation matrix defined by 3 points.	Matrix

## F.18. Metamodel-based Optimization strategies

Optimization strategy SINGLESTAGE	Single stage optimization	404
Optimization strategy SEQUENTIAL	Sequential optimization	404
Optimization strategy DOMAINREDUCTION	Sequential optimization with domain reduction	405

## F.19. Selecting an optimization method

Optimization method srs	Metamodel-based Optimization	402
Optimization method genalg	Genetic Algorithm	402

## F.20. Setting parameters for optimization algorithm

iterate param <i>identifier value</i>	Define parameters in LFOPC	407
---------------------------------------	----------------------------	-----

## F.21. Selecting an optimization algorithm for SRSM

Optimization algorithm lfopc	Leap Frog Optimizer (LFOPC)
Optimization algorithm genalg	Genetic Algorithm (GA)
Optimization algorithm simulated annealing	Adaptive Simulated Annealing (ASA)
Optimization algorithm hybrid ga	Hybrid GA/LFOPC
Optimization algorithm hybrid simulated annealing	Hybrid ASA/LFOPC